

**fimar**  
group

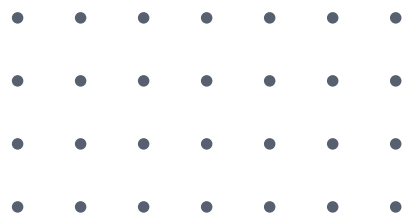

# FOOD PROCESSING EQUIPMENT

Attrezzature professionali per la ristorazione



**F** **fimar**<sup>®</sup>

**CATALOGO 2023/24**  
**CATALOGUE 2023/24**





# Guida alla lettura

## IT

Fimar S.P.A. dal 1979, è un'azienda italiana specializzata in progettazione, produzione e vendita di macchinari per la ristorazione professionale.

Fimar conta oltre 100.000 macchine vendute in un anno, più di 5.000 distributori mondiali in 100 Paesi nel mondo, una superficie di copertura totale di 38.000 metri quadrati ubicati a Villa Verucchio.

Offriamo un servizio clienti e assistenza di altissima qualità grazie ad un personale multilingua preparato ed efficiente.

## EN

Fimar S.P.A. since 1979, is an Italian company dedicated to the design, production and sale of professional catering machinery.

Fimar numbers over 100,000 machines sold in one year, more than 5,000 distributors worldwide in 100 different countries, a production area of 38,000 square meters located in Villa Verucchio.

We provide the highest quality of customer service and assistance thanks to our skilled and highly efficient multilingual staff.

## FR

Fimar S.P.A. depuis 1979, est une entreprise italienne dédiée à la conception, à la production et à la vente de machines pour la restauration professionnelle.

Fimar compte plus de 100.000 machines vendues en un an, plus de 5.000 distributeurs dans 100 pays différents, une surface de production de 38.000 mètres carrés située à Villa Verucchio.

Nous offrons un service à la clientèle et une assistance de la plus haute qualité grâce à notre personnel multilingue compétent et hautement efficace.

CERCA IL BOLLINO NOVITÀ E SCOPRILE TUTTE!  
LOOK FOR THE NEW STICKER AND DISCOVER THEM ALL!  
Cherchez la vignette de la nouveauté et découvrez-les tous!  
Achten Sie auf den Neuheitsaufkleber und entdecken Sie sie alle!  
¡Busque la etiqueta de novedad y descúbralos todos!  
Найдите наклейку с новинкой и откройте для себя их все!



## DE

Fimar S.P.A. ist ein italienisches Unternehmen, das sich seit 1979 auf die Entwicklung, Produktion und den Verkauf von professionellen Gastronomiemaschinen spezialisiert hat.

Fimar zählt über 100.000 verkaufte Maschinen in einem Jahr, mehr als 5.000 Händler weltweit in 100 verschiedenen Ländern, eine Produktionsfläche von 38.000 Quadratmetern in Villa Verucchio.

Dank unserer qualifizierten und hocheffizienten mehrsprachigen Mitarbeiter bieten wir höchste Qualität bei Kundenservice und -betreuung.

## ES

Fimar S.P.A. desde 1979, es una empresa italiana que se dedica a diseñar, fabricar y vender máquinas profesionales para el catering.

Fimar cuenta con más de 100.000 máquinas vendidas en un año, más de 5.000 distribuidores en todo el mundo en 100 países diferentes, un área de producción de 38.000 metros cuadrados ubicada en Villa Verucchio.

Gracias a nuestro personal multilingüe altamente cualificado y eficiente, ofrecemos la mejor calidad de servicio y asistencia al cliente.

## RU

















Fimar S.P.A. - это итальянская компания, специализирующаяся с 1979 года на разработке, производстве и продаже профессионального оборудования для общественного питания.





Fimar продает более 100 000 машин в год, более 5 000 дилеров по всему миру в 100 различных странах, производственная площадь 38 000 квадратных метров в районе Villa Verucchio.

















Благодаря высококвалифицированному и высокоэффективному многоязычному персоналу мы предлагаем высочайшее качество обслуживания и поддержки клиентов.





















# Icone

ICONS  
ICÔNES  
SYMBÔLE  
ICONOS  
ИКОНКИ

	IT	EN	FR	DE	ES	RU
	INFORMAZIONI	INFORMATION	INFORMATION	INFO	INFORMACIÓN	ИНФОРМАЦИЯ
	POTENZA	POWER	PUISSANCE	LEISTUNG	POTENCIA	МОЩНОСТЬ
	POTENZA GAS	GAS POWER	PUISSANCE GAZ	GASLEISTUNG	ENERGÍA DE GAS	ГАЗОВАЯ ЭНЕРГИЯ
 3 Ph	ALIMENTAZIONE TRIFASE	THREE-PHASE POWER SUPPLY	ALIMENTATION TRIPHASÉE	DREIPHASIGE STROMVERSORGUNG	ALIMENTACIÓN TRIFÁSICA	ТРЕХФАЗНЫЙ ИСТОЧНИК ПИТАНИЯ
 1 Ph	ALIMENTAZIONE MONOFASE	SINGLE-PHASE POWER SUPPLY	ALIMENTATION MONOPHASÉE	EINPHASIGE STROMVERSORGUNG	ALIMENTACIÓN MONOFÁSICA	ОДНОФАЗНЫЙ ИСТОЧНИК ПИТАНИЯ
 mm	DIMENSIONI MACCHINA	MACHINE DIMENSIONS	DIMENSIONS DES MACHINES	MASCHINE NABMESSUNGEN	MEDIDAS MÁQUINA	РАЗМЕРЫ СТАНКА
	INFO SPEDIZIONI	DELIVERY INFO	INFORMATIONS SUR LA LIVRAISON	VERSANDINFO	INFORMACIÓN SOBRE ENVÍO	ИНФОРМАЦИЯ ИНФОРМАЦИЯ ШИППИНГА
 Kg	PESO NETTO	NET WEIGHT	POIDS NET	NETTOGEWICHT	PESO NETO	ВЕС НЕТТО
 Kg	PESO LORDO	GROSS WEIGHT	POIDS BRUT	BRUTTOGEWICHT	PESO BRUTO	ВЕС БРУТТО
 mm	DIMENSIONI DI IMBALLO	PACKAGING DIMENSIONS	DIMENSIONS DES EMBALLAGES	VERPACKUNGSMASSE	MEDIDAS DEL EMBALAJE	РАЗМЕРЫ УПАКОВКИ
 m³	VOLUME DI IMBALLO	PACKAGING VOLUME	VOLUME D'EMBALLAGE	VERPACKUNGSSUMFANG	VOLUMEN DEL EMBALAJE	ОБЪЕМ УПАКОВКИ
	PREZZO	PRICE	PRIX	PREIS	PRECIO	ПРИСЕ
	CE	CE	CE	CE	CE	CE
	NO CE	NO CE	NO CE	KEIN CE	NO CE	НЕТ CE
 RPM	VELOCITÀ	SPEED	VITESSE	GESCHWINDIGKEIT	VELOCIDAD	БЫСТРОТА
	CAPACITÀ NOMINALE	NOMINAL CAPACITY	CAPACITÉ NOMINALE	NENNKAPAZITÄT	CAPACIDAD NOMINAL	НОМИНАЛЬНАЯ МОЩНОСТЬ
 Kg/h	PRODUZIONE ORARIA	HOURLY PRODUCTION	PRODUCTION HORAIRE	STUNDENPRODUKTION	PRODUCCIÓN HORARIA	ПОЧАСОВОЕ ПРОИЗВОДСТВО

	IT	EN	FR	DE	ES	RU
	DIMENSIONI DEL PIANO DI LAVORO	DIMENSIONS OF THE WORKTOP	DIMENSIONS DU PLAN DE TRAVAIL	ABMESSUNGEN DER ARBEITSPLATTE	MEDIDAS DEL PLAN DE TRABAJO	РАЗМЕРЫ СТОЛЕШНИЦЫ
	DIMENSIONI INTERNE DELLA MACCHINA	INTERNAL DIMENSIONS OF THE MACHINE	DIMENSION INTÉRIEURE DE LA MACHINE	INNENMASS DER MASCHINE	MEDIDA INTERIOR DE LA CUCHILLA	ВНУТРЕННИЙ РАЗМЕР МАШИНЫ
	TIPO DI GAS	TYPE OF GAS	TYPE DE GAZ	GASTYP	TIPO DE GAS	ВИД ГАЗА
	NUMERO DI BRUCIATORI	NUMBER OF BURNERS	NOMBRE DE BRÛLEURS	ANZAHL DER BRENNER	NÚMERO DE QUEMADORES	КОЛИЧЕСТВО ГОРЕЛОК
	NUMERO DI PIEZOELETRICI	NUMBER OF PIEZOELECTRICS	NOMBRE DE PIÉZOÉLECTRIQUES	ANZAHL DER PIEZOELEMENTE	NÚMERO DE PIEZOELÉCTRICOS	КОЛИЧЕСТВО ПЬЕЗОЭЛЕКТРИКОВ
	TRITACARNE	MEAT MINCER	HACHOIR À VIANDE	SFLEISCHWOLF	PICADORA DE CARNE	ИЗМЕЛЬЧЕНИЯ МЯСА
	GRATTUGIA	GRATER	RÂPE	REIBE	RALLADOR	ТЕРКИ
	SVILUPPO LAMA	BLADE EXTENSION	EXTENSION DE LAME	KLINGENLÄNGE	LARGO DE LA CUCHILLA	ДЛИНА НОЖА
	TAGLIO UTILE	CUTTING WIDTH	LARGEUR DE COUPE	SCHNITTWEITE	ANCHO DE CORTE	ШИРИНА РЕЗА
	LAMA SEGAOSSA	BONE SAW BLADE	LAME DE SCIE À OS	KNOCHENSÄGE-KLINGE	CUCHILLA SIERRA PARA HUESOS	НОЖА ПОЛЕЗНАЯ КОСТНАЯ ПИЛА
	NUMERO DI PALE	NUMBER OF BLADES	NOMBRE DE PELLÉS	ANZAHL DER SCHAUFELN	NÚMERO DE PALAS	КОЛИЧЕСТВО ЛОПАТ
	IMBUTO	FUNNEL	ETONNOIR	TRICHTER	EMBUDO	НАСАДКИ
	CAPACITÀ DELLA VASCA	CAPACITY OF THE BOWL	CAPACITÉ DU CONTENANT	BEHÄLTERKAPAZITÄT	CAPACIDAD RECIPIENTE	ВМЕСТИМОСТЬ СМЕСИТЕЛЬНОГО БАКА
	IMPASTO PER CICLO	DOUGH FOR CYCLE	PÂTE PAR CYCLE	TEIG PRO ZYKLUS	MASA PARA CICLO	КОЛ-ВО ТЕСТА ЗА ЦИКЛ
	TIMER	TIMER	MINUTERIE	SCHALTUHR	TEMPORIZADOR	ТАЙМЕР
	TRAFILE	MOULDS	FILIÈRES	EINSÄTZE	MOLDES	ВСТАВОК
	LUNGHEZZA RULLI	ROLLER LENGTH	LONGUEUR DU ROULEAU	ROLLENLÄNGE	LONGITUD RODILLOS	РОЛЛЕР ЛЕНГТЬ
	APERTURA RULLI	ROLLER OPENING	OUVERTURE DU ROULEAU	ROLLEN-ÖFFNUNG	APERTURA RODILLOS	РОЛЛЕР ОТКРЫТИЕ
	MESCOLATORE	BLENDER	MÉLANGEUR	RÜHRER	MEZCLADOR	СМЕСИТЕЛЯ

	IT	EN	FR	DE	ES	RU
	FRUSTA	WHISK	FOUET	SCHNEEBESEN	BATIDOR	ВЕНЧИКА
	BLOCCO MOTORE	MOTOR UNIT	GROUPE MOTEUR	MOTOREINHEIT	BLOQUE MOTOR	МОТОРНЫМ БЛОКОМ
 RPM	BLOCCO MOTORE CON VARIATORE	MOTOR UNIT WITH SPEED REGULATOR	GROUPE MOTEUR AVEC MOTORÉDUCTEUR	MOTOREINHEIT MIT DREHZAHLEGLER	BLOQUE MOTOR CON VARIADOR	МОТОРНЫМ БЛОКОМ С ВАРИАТОРОМ СКОРОСТИ
 RPM	BLOCCO MOTORE CON VARIATORE E FRUSTA	MOTOR UNIT WITH SPEED REGULATOR AND WHISK	GROUPE MOTEUR AVEC MOTORÉDUCTEUR ET FOUET	MOTOREINHEIT MIT DREHZAHLEGLER UND SCHNEEBESEN	BLOQUE MOTOR CON VARIADOR Y BATIDOR	МОТОРНЫМ БЛОКОМ С ВАРИАТОРОМ СКОРОСТИ И ВЕНЧИК
 RPM	BLOCCO MOTORE CON VARIATORE E MESCOLATORE	MOTOR UNIT WITH SPEED REGULATOR AND BLENDER	GROUPE MOTEUR AVEC MOTORÉDUCTEUR ET MÉLANGEUR	MOTOREINHEIT MIT DREHZAHLEGLER UND RÜHRER	BLOQUE MOTOR CON VARIADOR Y MEZCLADOR	МОТОРНЫМ БЛОКОМ С ВАРИАТОРОМ СКОРОСТИ И СМЕСИТЕЛЯ
	LIVELLO MASSIMO DI IMMERSIONE	IMMERSION LIMIT	NIVEAU MAXIMAL D'IMMERSION	MAXIMALE EINTAUCHTIEFE	MÁXIMO NIVEL DE INMERSIÓN	МАКС. УРОВЕНЬ ПОГРУЖЕНИЯ ВЕНЧИКА
	DIMENSIONE DELLA LAMA	BLADE SIZE	TAILLE DE LA LAME	KLINGENGRÖSSE	MEDIDA DE LA CUCHILLA	НОЖА
	TAGLIO UTILE	USEFUL CUT	COUPE UTILE	NÜTZLICHER SCHNITT	ÚTIL DE CORTE	ПОЛЕЗНАЯ ДЛИНА РЕЗКИ
	BARRA SALDANTE/ HOT-WELD SEALER	SEALING BAR	BARRE DE SOUDURE	SCHWEISSSTAB	BARRA TERMOSELLADO	СВАРОЧНАЯ ПЛАНКА
	POMPA VUOTO/ VACUUM PUMP	VACUUM PUMP	POMPE A VIDER	VAKUUM PUMPE	BOMBA VACÍO	ВАКУУМНЫЙ НАСОС
	VUOTO MAX OTTENIBILE/ MAX ACHIEVABLE VACUUM	MAX OBTAINABLE VACUUM	VIDE MAX POSSIBLE	MAX MÖGLICHES VAKUUM	MÁXIMO VACÍO OBTENIBLE	МАКСИМАЛЬНО ДОСТИЖИМЫЙ ВАКУУМ
	PRODUZIONE ORARIA NUMERO PEZZI	HOURLY PRODUCTION NUMBER OF PIECES	PRODUCTION HORAIRE NOMBRE DE PIÈCES	STÜNDLICHE PRODUKTION TEILEANZAHL	PRODUCCIÓN HORARIA NÚMERO DE PIEZAS	ПОЧАСОВОЕ ПРОИЗВОДСТВО КОЛИЧЕСТВО ШТУК
	TEMPERATURA DI LAVORO	WORKING TEMPERATURE	TEMPÉRATURE DE FONCTIONNEMENT	BETRIEBSTEMPERATUR	TEMPERATURA DE TRABAJO	РАБОЧАЯ ТЕМПЕРАТУРА
	CAPACITÀ/DIMENSIONI DELLA CAMERA DI COTTURA	CAPACITY / DIMENSIONS OF THE COOKING CHAMBER	CAPACITÉ/DIMENSIONS DE LA CHAMBRE DE CUISSON	KAPAZITÄT / ABMESSUNGEN DES GARRAUMS	CAPACIDAD / DIMENSIONES DE LA CÁMARA DE COCCIÓN	ВМЕСТИМОСТЬ / ГАБАРИТЫ ВАРОЧНОЙ КАМЕРЫ
	kcal/h BTU/h	CALORIE	CALORIES	KALORIEN	CALORÍAS	КАЛОРИИ
	METANO METHANE METAHA	CONSUMO METANO	CONSUMATION DE MÉTHANE	METHANVERBRAUCH	CONSUMO METANO	ПОТРЕБЛЕНИЕ МЕТАНА
	GPL LPG	CONSUMO GPL	CONSUMATION DE LPG	LPG-VERBRAUCH	CONSUMO GPL	ПОТРЕБЛЕНИЕ LPG

	IT	EN	FR	DE	ES	RU
	RAGGIUNGIMENTO DELLA TEMPERATURA	TEMPERATURE ACHIEVEMENT	TEMPÉRATURE ATTEINTE	EINGESTELLTE TEMP. ERREICHT	ALCANCE TEMPERATURA	ДОСТИЖЕНИЕ ТЕМПЕРАТУРЫ
	NUMERO DI TEGLIE	NUMBER OF TRAYS	NOMBRE DE PLAQUES	ANZAHL DER BLECHE	NÚMERO BANDEJAS	КОЛИЧЕСТВО ЛОТКОВ
	CAPACITÀ OLIO	OIL CAPACITY	CAPACITÉ D'HUILE	ÖLKAAPAZITÄT	CAPACIDAD ACEITE	МАСЛО КАПАБИЛЬНОСТЬ
	CAPACITÀ DEL CESTO	CAPACITY OF THE BASKET	CAPACITÉ DUPANIER	KORBKAAPAZITÄT	CAPACIDAD CESTA	ВМЕСТИМОСТЬ КОРЗИНЫ
	DIMENSIONI DEL PIANO DI COTTURA	DIMENSIONS OF THE COOKING SURFACE	DIMENSIONS DE LA TABLE DE CUISSON	ABMESSUNGEN DER KOCHPLATTE	MEDIDAS DE LA PLACA DE COCCIÓN	РАЗМЕРЫ ВАРОЧНОЙ ПАНЕЛИ
	ALTEZZA UTILE PER LA COTTURA	USEFUL COOKING HEIGHT	HAUTEUR UTILE POUR LA CUISSON	NUTZHÖHE ZUM KOCHEN	ALTURA ÚTIL PARA LA COCCIÓN	ПОЛЕЗНАЯ ВЫСОТА ДЛЯ ПРИГОТОВЛЕНИЯ ПИЩИ
	CAPACITÀ CARNE	MEAT CAPACITY	CAPACITÉ DE VIANDE	FLEISCHKAPAZITÄT	CAPACIDAD CARNE	ПОТЕНЦИАЛЬНЫЙ МЯС ПОТЕНЦИАЛЬНЫЙ
	RESISTENZE	HEATING ELEMENTS	RESISTANCES	HEITZSTÄBE	RESISTENCIAS	РЕЗИСТАНЦИИ
	CAPACITÀ DEL BICCHIERE	GLASS CAPACITY	CAPACITÉ DU VERRE	BECHERKAAPAZITÄT	CAPACIDAD VASO	ЁМКОСТЬ СТЕКЛА
	SUPERFICIE DELLA PIASTRA	PLATE SURFACE	SURFACE DE LA PLAQUE	OBERFLÄCHE DER PLATTE	SUPERFICIE DE LA PLACE	ПОВЕРХНОСТЬ ПЛИТЫ
	DIMENSIONE RULLI	ROLLER DIMENSIONS	LONGUEUR DES ROULEAUX	ROLLENLÄNGE	LARGO RODILLOS ДЛИНА ВАЛКОВ	DIMENSIONE RULLI
	DIMENSIONE BOBINA	COIL DIMENSION	TAILLE DE BOBINE	SPÜLENGRÖÖE	TAMAÑO DE BOBINA	РАЗМЕР КАТУШКИ
	POMPA LAVAGGIO	WASHING PUMP	POMPE DE LAVAGE	WASCHPUMPE	BOMBA DE LAVADO	МОЕЧНЫЙ НАСОС
	CONSUMO ACQUA PER CICLO	WATER CONSUMPTION PER CYCLE	CONSOMMATION D'EAU PAR CYCLE	WASSERVERBRAUCH PRO ZYKLUS	CONSUMO DE AGUA POR CICLO	РАСХОД ВОДЫ НА ЦИКЛ
	RESISTENZA BOILER	BOILER HEATING ELEMENT	RÉSISTANCE CHAUDIÈRE	KESSELHEIZSTAB	RESISTENCIA DE LA CALDER	НАГРЕВАТЕЛЬНЫЙ ЭЛЕМЕНТ КОТЛА
	CAPACITÀ BOILER	BOILER CAPACITY	CAPACITÉ CHAUDIÈRE	KESSELHEIZSTAB	CAPACIDAD DE LA CALDERA	МОЩНОСТЬ КОТЛА
	RESISTENZA VASCA	TANK HEATING ELEMENT	RÉSISTANCE DU RÉSERVOIR	KESSELKAAPAZITÄT	RESISTENCIA DEL TANQUE	НАГРЕВАТЕЛЬНЫЙ ЭЛЕМЕНТ БАКА
	BRACCI DI LAVAGGIO E RISCIAQUO	WASH AND RINS ARMS	BRAS DE LAVAGE ET RINÇAGE	WASCH- UNS SPÜLARME	BRAZOS DE LAVADO Y ACLARADO	РУКОЯТКИ ДЛЯ МЫТЬЯ И ОМОЛАСКИВАНИЯ
	ALTEZZA MACCHINA BICCHIERI	MAX. GLASS HEIGHT	MAX. HAUTEUR VERRE	MAX. GLASHÖHE	MAX. ALTURA DEL VIDRIO	МАКС. ВЫСОТА СТАКАНОВ
	DIAMETRO MAX. PIATTI	MAX. PLATES DIAMETER	DIAMÈTRE MAX. ASSIETTE	MAX. TELLERDURCHMESSER	MAX. DIÁMETRO DE LAS PLACAS	МАКС. ДИАМЕТР ТАРЕЛКИ
	CONSUMO ACQUA PER CICLO	WATER QUANTITY PER CYCLE	QUANTITÉ D'EAU PAR CYCLE	WASSERVERBRAUCH JE ZYKLUS	CONSUMO DE AGUA POR CICLO	РАСХОД ВОДЫ НА ЦИКЛ



22



LAVORAZIONE CARNE  
MEAT PROCESSING  
PREPARATION DE LA VIANDE FLEISCHVERARBEITUNG  
ELABORACIÓN CARNE  
ОБРАБОТКА МЯСА

96



LAVORAZIONE PASTA  
PASTA PROCESSING  
TRAVAIL DE LA PATE TEIGVERARBEITUNG  
ELABORACIÓN PASTA  
ОБРАБОТКА ТЕСТА

164



TAGLIO, PELATURA E CONSERVAZIONE  
CUTTING PEELING AND CONSERVATION  
COUPE PELAGE ET CONSERVATION  
SCHNEIDEN, SCHÄLEN UND LAGERN  
CORTAR, PELAR Y CONSERVAR  
РЕЗКА, ОТСЛАИВАНИЕ И ХРАНЕНИЕ

274



COTTURA  
COOKING  
CUISSON GAREN  
COCCIÓN  
ПРИГОТОВЛЕНИЕ

400



SNACK BAR  
ЗАКУСОЧНАЯ

444



LAVAGGIO  
WASH  
LAVER  
WASCHEN  
СТИРАТЬ





# Indice

INDEX  
TABLE DES MATIÈRES  
INHALTSVERZEICHNIS  
INDEX  
СОДЕРЖАНИЕ

IT	EN	FR	DE	ES	RU	
CONDIZIONI GENERALI DI VENDITA	GENERAL SALES CONDITIONS	CONDITIONS GÉNÉRALES DE VENTE	ALLGEMEINE VERKAUFSBEDINGUNGEN	CONDICIONES GENERALES DE VENTA	ОБЩИЕ УСЛОВИЯ ПРОДАЖИ	20

IT	EN	FR	DE	ES	RU	
TRITACARNE REFRIGERATO	REFRIGERATED MEAT MINCER	HACHOIR À VIANDE RÉFRIGÉRÉ	GEKÜHLTER FLEISHWOLF	PICADORA DE CARNE REFRIGERADA	ОХЛАЖДАЕМАЯ МЯСОРУБКА	24
TRITACARNE	MEAT MINCER	HACHOIR À VIANDE	FLEISHWOLF	PICADORA DE CARNE	МЯСОРУБКА	26
ABBINATO TRITACARNE GRATTUGIA	COMBINED MEAT MINCER AND GRATER	COMBINE HACHOIR A VIANDE ET RÂPE FROMAGE	GEKOPPELTE FLEISCHWOLF UND KÄSEREIBE	EQUIPO COMBINADO PICADORA DE CARNE Y RALLADOR	КОМБИНИРОВАННАЯ МЯСОРУБКА-ТЕРКА	64
GRATTUGIA	GRATER	RÂPE	KÄSEREIBE	RALLADOR	ТЕРКА	76
ABBINATO TRITACARNE GRATTUGIA AB8D - TR8D - GR8D	COMBINED MEAT MINCER AND GRATER AB8D - TR8D - GR8D	COMBINE HACHOIR A VIANDE ET RÂPE FROMAGE AB8D - TR8D - GR8D	GEKOPPELTE FLEISCHWOLF UND KÄSEREIBE AB8D - TR8D - GR8D	EQUIPO COMBINADO PICADORA DE CARNE Y RALLADOR AB8D - TR8D - GR8D	КОМБИНИРОВАННАЯ МЯСОРУБКА-ТЕРКА AB8D - TR8D - GR8D	78
SEGAOSSI A NASTRO	BONE BANDSAW	SCIÈ À OS	KNOCHENBANDSÄGE	SIERRAS PARA HUESOS CON CINTA	ЛЕНТОЧНЫЕ ПИЛЫ ДЛЯ АСПИЛА КОСТЕЙ	84
IMPASTATRICI PER CARNE	MEAT MIXER	MELANGEUR À VIANDE	FLEISCH MISCHMASCHINEN	AMASADORAS PARA CARNE	ФАРШЕМЕШАЛКИ	88
INSACCATRICI MANUALI	MANUAL SAUSAGE FILLERS	POUSOIRS À SAUCISSES MANUELS	MANUELLE WURSTFÜLLMASCHINEN	EMBUTIDORAS MANUALES	РУЧНЫЕ НАПОЛНИТЕЛИ КОЛБАС	92
PRESSAMBURGER	MANUAL HAMBURGER PRESS	PRESSE-HAMBURGER MANUELLE	MANUELLE HAMBURGERPRESSE	FORMADORA DE HAMBURGUESAS MANUAL	РУЧНОЙ ПРЕСС ДЛЯ ГАМБУРГЕРОВ	94

IT	EN	FR	DE	ES	RU	
IMPASTATRICE BERTA	"BERTA" KNEADER	"BERTA" PETRIN	"BERTA" TEIGKNETMASCHINE	"BERTA" AMASADORA	"BERTA" ТЕСТОМЕС	98
IMPASTATRICE A FORCELLA	FORK KNEADER	PETRISSEUSE À FOURCHE	GABELKNETER	AMASADORA DE HORQUILLA	ВИЛОЧНЫЙ ТЕСТОМЕС	102
IMPASTATRICE A SPIRALE	SPIRAL KNEADER	PETRIN A SPIRAL	SPIRALTEIGKNETMASCHINE	AMASADORA DE ESPIRAL	СПИРАЛЬНЫЙ ТЕСТОМЕС	106
IMPASTATRICE PLANETARIA	PLANETARY MIXER	MÉLANGEUR PLANÉTAIRE	PLANETENMISCHER	AMASADORA PLANETARIA	ПЛАНЕТАРНЫЙ ТЕСТОМЕС	134
MACCHINA PASTA FRESCA	PASTA MACHINE	MACHINE À PÂTE	NUDELMASCHINE	MÁQUINA PARA PASTA FRESCA	МАШИНКА ДЛЯ ПРИГОТОВЛЕНИЯ СВЕЖИХ МАКАРОННЫХ ИЗДЕЛИЙ	144
STENDIPIZZA	PIZZA ROLLER MACHINE	FAÇONNEUSE POUR PIZZA	PIZZATEIGAUSROLL MASCHINE	MÁQUINA PARA EXTENDER MASA DE PIZZA CON RODILLOS	ТЕСТОРАСКАТОЧНАЯ МАШИНА ДЛЯ ПИЦЦЫ	158
SFOGLIATRICI STENDIPIZZA	PASTA AND PIZZA ROLLER MACHINE	FAÇONNEUSE POUR PÂTE ET PIZZA	PIZZA- UND TEIGAUSROLLMASCHINE	MÁQUINA PARA EXTENDER MASA DE PIZZA CON RODILLOS	ТЕСТОРАСКАТОЧНАЯ МАШИНА ДЛЯ ПИЦЦЫ	162

IT	EN	FR	DE	ES	RU	
MIXER AD IMMERSIONE	IMMERSION BLENDER	MIXEUR À IMMERSION	EINTAUCH-MIXSTAB	TRITURADORA A INMERSIÓN	ПОГРУЖНОЙ БЛЕНДЕР	166
TAGLIAVERDURA	VEGETABLE CUTTER	COUPE-LÉGUMES	GEMÜSESCHNEIDER	CORTADORAS DE HORTALIZAS	ОВОЩЕРЕЗКА	176
TAGLIAMOZZARELLA	MOZZARELLA CUTTER	COUPE-MOZZARELLA	MOZZARELLASCHNEIDER	CORTADORAS DE MOZZARELLA	КУСАЧЕК МОЦАРЕЛЛЫ	190
CUTTER	CUTTER	CUTTER	CUTTER	CUTTER	CUTTER	194
PELATAPATE	POTATO PEELER	ÉPLUCHEUSE À POMMES DE TERRE	KARTOFFELSCHÄLER	PELAPAPAS	КАРТОФЕЛЕЧИСТКА	204
LAVACOZZE	MUSSEL WASHER	LAVE-MOULES	MUSCHELNWASCH-MASCHINE	LAVADORAS DE MEJILLONES	МАШИНА ДЛЯ ОЧИСТКИ МИДИЙ	212
LAVAVERDURE CENTRIFUGA	VEGETABLE WASHER AND DRYER	LAVEUSES À LÉGUMES ET ESSOREUSES	GEMÜSEWASCH-UND TROCKNERMASCHINE	LAVADORA DE VERDURAS Y CENTRIFUGADORA	ПРИБОР ДЛЯ МОЙКИ ОВОЩЕЙ И СУШКИ ЛИСТЬЕВ САЛАТА	222
AFFETTATRICI A VOLANO	FLYWHEEL MANUAL SLICER	TRANCHEUSES MANUELLES A VOLANT	SCHWUNGRAD-AUFSCHNITTMASCHINE	CORTADORAS CON VOLANTE	СЛАЙСЕРЫ С ПРИВОДОМ ОТ МАХОВИКА	224
AFFETTATRICI	SLICERS	TRANCHEUSES	AUFSCHNITTMASCHINEN	CORTADORAS DE FIAMBRE	СЛАЙСЕРЫ	226
MACCHINE SOTTOVUOTO A CAMPANA	CHAMBER VACUUM PACKERS	MACHINES SOUS VIDE À CLOCHE	KAMMER-VAKUUMVERPACKER	ENVASADORAS AL VACÍO	КОЛПАКОВЫЕ ВАКУУМНЫЕ УПАКОВОЧНЫЕ МАШИНЫ	244
MACCHINE SOTTOVUOTO A BARRA SALDANTE	BAR VACUUM PACKERS	MACHINES SOUS VIDE À BARRE	VAKUUMVERPACKER MIT SCHWEISSLEISTE	ENVASADORAS AL VACÍO CON BARRA	ВАКУУМНЫЕ УПАКОВОЧНЫЕ МАШИНЫ СО СВАРОЧНОЙ ПЛАНКОЙ	252
TERMOSIGILLATRICI	HEAT SEALERS	THERMOSCELLEUSES	THERMOVERSIEGELUNGS-GERÄTE	TERMOSELLADORAS	ТЕРМОЗАПЕЧА ТЫВАЮЩАЯ МАШИНА	262
ASCIUGA LUCIDA POSATE	CUTLERY DRYER-POLISHER	MACHINES À ESSUYER ET POLIR LES COUVERTS	BESTECKTROCKNER POLIERER	SECADORAS ABRILLANTADORAS DE CUBIERTOS	СУШИЛЬНОПО ЛИРОВОЧНАЯ МАШИНА ДЛЯ СТОЛОВЫХ ПРИБОРОВ	272

IT	EN	FR	DE	ES	RU	
COTTURA SOUS-VIDE	SOUS-VIDE COOKING	CUISSON SOUS-VIDE	VAKUUM GAREN	COCCIÓN SOUS-VIDE	ВАКУУМНАЯ ВАРКА	276
FORNI PIZZA ELETTRICI	ELECTRIC PIZZA OVENS	FOURS À PIZZA ÉLECTRIQUES	ELEKTRISCHE PIZZAÖFEN	HORNOS ELÉCTRICOS PARA PIZZA	ЭЛЕКТРИЧЕСКИЕ ПЕЧИ ДЛЯ ПИЦЦЫ	278
FORNETTO PER PIZZA	PIZZA OVEN	FOUR À PIZZA	PIZZAOFEN	HORNO PARA PIZZA	ПЕЧКА ДЛЯ ПИЦЦЫ	294
FORNI PIZZA A GAS	GAS PIZZA OVENS	FOURS À PIZZA À GAZ	GAS PIZZAÖFEN	HORNOS A GAS PARA PIZZA	ПЕЧИ ДЛЯ ПИЦЦЫ	296
CELLE DI LIEVITAZIONE PER FORNI PIZZA	PROVING CELLS FOR PIZZA OVENS	CELLULES DE FERMENTATION CONTROLÉE POUR FOURS À PIZZA	GÄRZELLEN FÜR PIZZAÖFEN	CÉLULAS DE FERMENTACIÓN PARA HORNOS DE PIZZA	ЯЧЕЙКИ РАССТРОЕЧНЫЕ ПЕЧЕЙ ДЛЯ ПИЦЦЫ	302

# Indice

INDEX  
TABLE DES MATIÈRES  
INHALTSVERZEICHNIS  
ÍNDICE  
СОДЕРЖАНИЕ









IT	EN	FR	DE	ES	RU	
CAPPE ASPIRANTI FORNI PIZZA	HOODS FOR PIZZA OVENS	HOTTES POUR FOURS À PIZZA	DUNSTABZUGSHAUBEN FÜR PIZZAÖFEN	CAMPANAS EXTRACTORAS PARA HORNOS DE PIZZA	ВЫТЯЖНЫЕ КОЛПАКИ ДЛЯ ПЕЧЕЙ ДЛЯ ПИЦЦЫ	308
FORNI MISTI A CONVEZIONE	MECHANICAL CONVECTION OVENS	FOURS À CONVECTION MÉCANIQUE	MECHANISCHE KOMBIÖFEN	HORNOS DE CONVECCIÓN MECÁNICA	МЕХАНИЧЕСКИЕ КОНВЕКЦИОННЫЕ ПЕЧИ	310
ARMADI LIEVITATORI	PROVING CABINET FOR OVENS	ARMOIRES DE LEVAGE POUR FOURS	GÄRSCHRÄNKE FÜR ÖFEN	ARMARIOS FERMENTADORES PARA HORNOS	ЯЧЕЙКИ РАССТРОЕЧНЫЕ ДЛЯ ПЕЧЕЙ	334
CUCINE A GAS	GAS RANGES	CUISINIÈRES À GAZ	GASHERD	COCINAS A GAS	ГАЗОВАЯ ПЛИТА	344
FRIGGITRICI ELETTRICHE	ELECTRIC FRYERS	FRITEUSES ÉLECTRIQUES	ELEKTRISCHE FRITEUSEN	FREIDORAS ELÉCTRICAS	ЭЛЕКТРИЧЕСКИЕ ФРИТЮРНИЦЫ	350
FRIGGITRICI A GAS	GAS FRYERS	FRITEUSES À GAZ	GAS FRITEUSEN	FREIDORAS A GAS	ГАЗОВЫЕ ФРИТЮРНИЦЫ	360
CUOCIPASTA ELETTRICI	ELECTRIC PASTA COOKERS	CUISEURS À PÂTE ÉLECTRIQUES	ELEKTRO NUDELKOCHER	COCEDORES DE PASTA ELÉCTRICOS	ЭЛЕКТРИЧЕСКИЕ МАКАРОНОВАРКИ	370
CUOCIPASTA A GAS	GAS PASTA COOKERS	CUISEURS À PÂTE À GAZ	GAS NUDELKOCHER	COCEDORES DE PASTA DE GAS	ГАЗОВЫЕ МАКАРОНОВАРКИ	372
GRIGLIE A PIETRA LAVICA	LAVA STONE GRILL	GRILLES À PIERE LAVIQUE	LAVASTEINGRILL	PARRILLAS DE PIEDRA LÁVICA	ГРИЛЬ С ЛАВОВЫМ КАМНЕМ	378
FRY TOP ELETTRICI	ELECTRIC FRY-TOPS	FRY-TOP ÉLECTRIQUE	ELEKTRISCHE FRY TOP	FRY TOP ELÉCTRICOS	ЭЛЕКТРИЧЕСКИЕ ЖАРОЧНЫЕ ПОВЕРХНОСТИ	382
FRY TOP GAS	GAS FRY TOP	FRY TOP A GAZ	GAS FRY TOP	FRY TOP A GAS	ГАЗОВЫЕ ЖАРОЧНЫЕ ПОВЕРХНОСТИ	386
GYROS ELETTRICI	ELECTRIC GYROS	GYROS ÉLECTRIQUES	ELEKTRISCHER GYROS	GYROS ELÉTRICOS	ЭЛЕКТРИЧЕСКИЕ ВЕРТИКАЛЬНЫЕ ШАШЛЫЧНИЦЫ	390
GYROS A GAS	GAS GYROS	GYROS A' GAZ	GAS GYROS	GYROS DE GAS	ГАЗОВЫЕ ВЕРТИКАЛЬНЫЕ ШАШЛЫЧНИЦЫ	394
SALAMANDRE	SALAMANDERS	SALAMANDER	SALAMANDER	SALAMANDRAS	ГРИЛЬ САЛАМАНДР	398



IT	EN	FR	DE	ES	RU	
FRULLATORI	MIXERS	MIXEURS	MIXER	BATIDORAS	БЛЕНДЕРЫ	402
FRULLATORI FRAPPÈ	MILKSHAKER	BLENDERS À FRAPPÉS	MILKSHAKERS	LICUADORAS FRAPPÉ	БЛЕНДЕРЫ ДЛЯ ПРИГОТОВЛЕНИЯ ФРАППЕ	408
SPREMIAGRUMI	JUICE SQUEEZER	PRESSE-AGRUMES	ZITRUSPRESSE	EXPRIMIDOR	СОКОВЫЖИМАЛКИ ДЛЯ ЦИТРУСОВЫХ	410
TRITAGHIACCIO	ICE CRUSHER	BROYEUR À GLACE	EISMÜHLE	PICADORA DE HIELO	ЛЕДОВАЯ ДРОБИЛКА	412
GRUPPI MULTIPLI	MULTIPLE GROUP	GROUPE MULTIPLE	MULTI-EINHEIT	GRUPO MÚLTIPLE	БАРНЫЙ КОМБАЙН	414
TOSTIERE SERIE TOP	TOASTER	TOASTEUR	TOASTER	PARILLA-TOSTADORA DE BANDEJA	ТОСТЕР	416
TOSTAPANE CONTINUO	CONTINUOUS TOASTER	GRLLE-PAIN CONTINU	DURCHLAUF-TOASTER	TOSTADORA DE PAN CONTINUA	НЕПРЕРЫВНЫЙ ТОСТЕР	418
PIASTRE ELETTRICHE IN VETROCERAMICA	PYRO CERAM GRILLS	PLAQUE EN VITROCÉRAMIQUE	GLASKERAMIKPLATTEN	PLACAS DE VITROCERÁMICA	СТЕКЛОКЕРАМИЧЕСКАЯ ПЛИТА	420
PIASTRE ELETTRICHE IN GHISA	CAST IRON ELECTRICAL GRILLS	PLAQUES ELECTRIQUES EN FONTE	GUSSEISENELEKTROPLATTEN	PLACAS ELÉCTRICAS DE FUNDICIÓN	ЭЛЕКТРИЧЕСКИЕ ПЛИТЫ	426
CREPIERE ELETTRICHE	ELECTRIC CRÊPES MACHINES	CRÊPIÈRES ÉLECTRIQUES	ELEKTRISCHE CRÊPES-MASCHINEN	MÁQUINA PARA CREPES ELÉCTRICA	ЭЛЕКТРИЧЕСКИЕ - ГАЗОВЫЕ БЛИННИЦЫ	432
CREPIERE A GAS	GAS CRÊPES MACHINES	CRÊPIÈRES À GAZ	GAS CRÊPES-MASCHINEN	MÁQUINA PARA CREPES DE GAS	ГАЗОВЫЕ БЛИННИЦЫ	436
CUOCI HOT DOG	HOT DOG	HOT DOG	HOT DOG	PERRITO CALIENTE	АППАРАТ ДЛЯ ПРИГОТОВЛЕНИЯ ХОТ-ДОГОВ	438
PRESSAGELATO	ICE CREAM PRESS	PRESSE-GLACE	EISPRESSE	PRENSADOR PARA HELADO	ПРЕСС ДЛЯ МОРОЖЕНОГО	442







IT	EN	FR	DE	ES	RU	
LAVABICCHIERI	GLASSWASHER	LAVE-VERRES	GLÄSERSPÜLMASCHINE	LAVAVASOS	ПОСУДОМОЕЧНАЯ МАШИНА	446
LAVASTOVIGLIE	DISHWASHER	LAVE-VAISSELLES	SPÜLMASCHINE	LAVAVAJILLA	ПОСУДОМОЕЧНАЯ МАШИНА	450
PRODOTTI PER LA PULIZIA	CLEANING PRODUCTS	PRODUITS DE NETTOYAGE	REINIGUNGSMITTEL	PRODUCTOS DE LIMPIEZA	ЧИСТЯЩИЕ СРЕДСТВА	458

















# Indice

INDEX  
TABLE DES MATIÈRES  
INHALTSVERZEICHNIS  
INDEX  
СОДЕРЖАНИЕ



CODICE / CODE	
22REFI	24
32REFI	24
32TN	26
32TND 	28
32TNE 	30
32RS	32
32RSD 	34
32RSE 	36
22RG	38
22RGE 	40
22RS	42
22RSE 	44
22TS	46
22TSE 	48
22SN	50
22TE	52
22CE 	54
12TS	56
12CE 	58

CODICE / CODE	
12S	60
12B	62
22AT	64
22ATE 	66
22T	68
22AE	70
12AT	72
12T	74
GR12S	76
AB8D	78
TR8D	80
GR8D	80
SE1550A	84
SE1830A	84
SE2020A	84
SE1550V	86
SE1830V	86
SE2020V	86
30C1PN 	88

CODICE / CODE	
50C1PN 	88
50C2PN 	88
75C1PN 	90
95C2PN 	90
115C2PN	90
150C2PN	90
LT7OR	92
LT7VE	92
LT14OR	92
LT14VE	92
F10	94
F13 	94
BERTA7	98
BERTA15	98
BERTA25	100
BERTA35	100
FF30N	102
12SR 	106
18SR 	106

CODICE / CODE	
25SR 	108
38SR 	108
50SR 	110
12SL 	112
18SL 	112
25SL 	114
38SL 	114
50SL 	116
7SB 	118
12SB 	120
18SB 	120
25SB 	122
38SB 	122
50SB 	124
15LN 	126
20LN	126
30LN	128
40LN 	128
PLN40D	134

CODICE / CODE	
PLN60D	134
PLN80D	134
PLN12BV	136
PLN20BV	136
PLN20V	138
PLN40V	138
PLN60V	138
PLN80V	138
PLN20M	140
PLN40M	140
PLN60M	140
PF15E	 144
PF25EN	 146
PF40EN	 146
MPF1.5N	148
MPF2.5N	150
MPF2.5CN	150
MPF4N	152
MPF8N	152





CODICE / CODE	
CARPF	156
FI32N	158
FI42N	158
FIP42N	158
FIM42	160
SI320	162
SI420	162
SI520	162
MX20	 166
MX20V2	 166
MX20VV	 166
MX25	168
MX40	170
FX40	172
TV4000	176
TV2000RN	178
TV3000N	180
TV2500	182
TAC	190

CODICE / CODE	
TAS	190
CL3N	194
CL5N	194
CL8N	194
CL5NV2	196
CL8NV2	196
BC3N	198
BC5N	198
BC8N	198
BC5NV	200
BC8NV	200
PPN5	204
PPF5	204
PPN10M	206
PPF10M	206
PPN18M	208
PPF18M	208
PPN25	210
PPF25	210

CODICE / CODE	
LCN5	212
LCF5	212
LCN10M	214
LCF10M	214
LCN18M	216
LCF18M	216
LAV	222
VV300	224
VV350	224
ECO220	226
ECO250	226
ECO300	226
ECO300L	228
ECO330	228
H220N	230
H250N	230
H275N	230
H300N	232
H330	232









# Indice

INDEX  
TABLE DES MATIÈRES  
INHALTSVERZEICHNIS  
ÍNDICE  
СОДЕРЖАНИЕ

CODICE / CODE		CODICE / CODE		CODICE / CODE		CODICE / CODE	
H350	232	CAM700TC	246	SV25	276	CL - FML - FYL - FMD FMLW - FME - FES - MINI	302
H370	232	CAM900TC	246	RH50	276	CL - FGI4 - FGI6 - FGI9	307
HL300	234	CAM300E	248	FMD	278	CAPPE	308
HR250	236	CAM350E	248	FMDW	278	SLIM6D 	310
HR300N	236	CAM400E	250	FML	282	SLIM623D 	310
V250	238	CAM450E	250	FME	282	SLIM6M 	312
VR300N	238	MSD300P	252	FYL	286	SLIM623M 	312
VM300	238	BAR300P	254	FES	286	TOP4TN	314
V330	240	BAR350	254	MICROV1C	290	TOP6TN	314
V350	240	BAR400	256	MICRO1C	290	TOP10TN	314
V370	240	BAR500	256	MICROV2C	290	TOP4DN	316
K300	242	TS300	262	MICRO2C	290	TOP6DN	316
K330	242	TS400	262	MINI	290	TOP10DN	316
K350	242	TS1A	264	MICROV18C	292	TOP4M	318
K370	242	TS2A	264	MICROV22C	292	TOP6M	318
CAM300T	244	TS3A	266	FP	294	TOP10M	318
CAM400T	244	TS1	268	FGI4	296	STR6	320
CAM500T	244	TS2	268	FGI6	296	STR10	320
CAM500TC	246	ALP3000	272	FGI9	296	CMP423D	322



CODICE / CODE	
CMP4GPD	322
CMP4GPM	324
CMP4GPMI	324
CMP332M	326
CMP423M	326
FN423E	328
FN423EV	328
FN423M	330
FN423MV	330
FN423G	332
FN423GV	332
FOALTOP10T	334
FOALTOP64T	334
FOALSTR	334
FOALCMP4GP	336
FOALCMP423	336
CC74GFEV	344
CC76GFEV	344
CC74GFG	346

CODICE / CODE		
CC76GFG		346
CC74G		348
CC76G		348
CC74P		348
FR4N		350
FR44N		350
FR8N		352
FR88N		352
FR8RN		352
FR88RN		352
FR10RN		354
FR1010RN		354
SFM18		356
SFM18D		356
SF25P		358
SF10M		360
SF10DM		360
SFM20M		362
SFM20DM		362

CODICE / CODE	
CP11N	370
CPM30	370
CPM30M	372
CPM30DM	372
GL33	378
GL66	378
B50	380
B80	380
B115	380
FRY1L	382
FRY1LC	382
FRY1R	382
FRY1RC	382
FRY2L	384
FRY2LC	384
FRY2LR	384
FRY2LRC	384
FRY2VCE	384
FRY1LM	386

CODICE / CODE	
FRY1LMC	386
FRY1RM	386
FRY1RMC	386
FRY2LM	388
FRY2LMC	388
FRY2LRM	388
FRY2LRMC	388
GYR40	390
GYR60	390
GYR80	392
GYR100	392
GYR60M	394
GYR80M	394
GYR80MD	394
RS40	398
RS70	398
SAL600MB	398
FR15OI	402
FR15OP	402

# Indice

INDEX  
TABLE DES MATIÈRES  
INHALTSVERZEICHNIS  
ÍNDICE  
СОДЕРЖАНИЕ

CODICE / CODE		CODICE / CODE		CODICE / CODE		CODICE / CODE	
FR200P	402	PV27LR	420	RW8	440	HC-IGIENGELF5L	462
FR2150I	404	PV40LL	422	PGEL	442	HC-GELSTK200	463
FR2150P	404	PV40LR	422	LABI35	446	HC-GELSTK1000	463
FP1I	408	PV55LL	424	LABI35PL	446		
FP1P	408	PV55LR	424	LABI40	448		
FP2I	408	PE25NL	426	LABI40PL	448		
FP2P	408	PE25NR	426	LAPI50	450		
SPM	410	PE35NL	428	LAPI50PL	450		
SPL	410	PE35NR	428	LAPI50C	452		
TRL	412	PE50NL	430	LAPI50CPL	452		
ROGM	412	PE50NR	430	HC-DEGREASERF750	458		
GP2SF	414	PE50NM	430	HC-DEGREASERF5K	458		
GP2FR	414	CRPN	432	HC-SANICLEANF750	459		
GP3SFF	414	CRP2N	432	HC-SANICLEANF5L	459		
TOP3D	416	CRP4	434	HC-MULTIF750	460		
TOP6D	416	CRP42	434	HC-MULTIF5K	460		
TOC	418	CR400G1	436	HC-FLASHF750	461		
TOCS	418	CR400G2	436	HC-FLASHF5K	461		
PV27LL	420	WD3	438	HC-IGIENGELF500	462		



# Condizioni generali di vendita

GENERAL SALES CONDITIONS  
CONDITIONS GÉNÉRALES DE VENTE  
ALLGEMEINE VERKAUFSBEDINGUNGEN  
CONDICIONES GENERALES DE VENTA  
ОБЩИЕ УСЛОВИЯ ПРОДАЖИ

IT

**COSTO DELL' IMBALLO:** compreso nel prezzo per le macchine; per ricambi ed accessori è previsto un contributo di € 8,00.

**COSTO FISSO GESTIONE ORDINI:** € 10,00 solo per ordini di importo inferiore a € 100,00.

**ORDINI:** gli ordini devono essere trasmessi esclusivamente in forma scritta; nuovi ordini o eventuali modifiche trasmesse in forma orale non verranno accettate.

**CONDIZIONI DI PAGAMENTO:** Si richiede il pagamento con bonifico bancario per: 1. Prime forniture. - 2. Al superamento del fido. - 3. Invio di ricambi.

**DILAZIONI DI PAGAMENTO:** da definire.

Sulle somme pagate in ritardo rispetto alla scadenza pattuita, saranno addebitati gli interessi di mora al tasso legale. Eventuali note di accredito saranno detratte nella fattura successiva.

**PREZZI:** non sono impegnativi, possono subire variazioni senza obbligo di preavviso, in tal caso saranno confermati all'ordine. Tutti i prezzi sono esclusi di IVA.

**TERMINI DI CONSEGNA:** 1. Per l'Italia, possibile spedizione in 24 ore per macchine disponibili a magazzino. 2. Per macchine da produrre considerare circa 25 giorni salvo imprevisti.

**TRASPORTO:** FRANCO FABBRICA, la merce viaggia a rischio e pericolo del committente, per cui Fimar S.p.a. non è responsabile per eventuali danni subiti dalla merce durante il trasporto. Eventuali contestazioni dovranno essere effettuate all'atto della consegna entro i termini di legge.

**ASSISTENZA TECNICA:** a carico del rivenditore per tutta la durata della garanzia di anni uno. Fimar S.p.a. si impegna a fornire, in garanzia, tutti i componenti di ricambio ritenuti difettosi. Il prezzo di vendita fatturato all'utilizzatore finale comprenderà non solo il prezzo dei prodotti finiti venduti, ma anche la gestione da parte del rivenditore della garanzia a copertura di essi. Fimar S.p.a. non dovrà sostenere alcuna spesa diretta o indiretta sostenuta dal rivenditore per la gestione della garanzia. La garanzia decade sul prodotto danneggiato o compromesso da un uso scorretto o comunque non conforme.

**INSTALLAZIONE:** installazione ed istruzione sull'utilizzo delle macchine e dei suoi accessori sono a carico del rivenditore.

**RIPARAZIONI:** nel caso in cui un preventivo di riparazione non venga accettato verranno addebitati € 25,00 quale concorso spese dei costi di gestione.

**GARANZIA:** 12 mesi.

**RESI:** per eventuali resi autorizzati di merce con imballo integro, sarà trattenuta una quota pari al 15% del valore, con un minimo di € 50.

**ASSICURAZIONE:** tutte le nostre macchine sono coperte da assicurazione (responsabilità civile verso terzi) Escluso U.S.A. e CANADA.

**CATALISTINO:** la presente documentazione annulla tutte le precedenti. I dati tecnici, le illustrazioni e le immagini riportate nella presente, sono puramente indicativi. La Ditta si riserva il diritto di modificare le caratteristiche tecniche ed estetiche o sospendere, in ogni momento, la propria produzione senza obbligo di preavviso.

**IMMAGINI ED ILLUSTRAZIONI:** tutte le immagini realizzate dal produttore sono coperte da copyright. L'utilizzo o la riproduzione delle medesime sono soggette ad autorizzazione da parte della Ditta proprietaria del marchio e detentrica dei diritti di proprietà materiale ed intellettuale. I prezzi o i dati tecnici potranno subire variazioni nel caso di errori tipografici o di cambiamenti in corso d'opera.

**MARCHI E BREVETTI:** è fatto espresso divieto di utilizzare i marchi e/o i brevetti registrati dalla Fimar S.p.a. Si precisa che tutti i macchinari e gli accessori non marcati CE presentano caratteristiche specifiche che non li rendono idonei alla vendita all'interno dei paesi dell'Unione Europea.

**RICHIESTA DI DOCUMENTAZIONE TECNICA AGGIUNTIVA:** Copia conforme all'originale della Certificazione CE: € 20,00 + spese di spedizione - Copia cartacea del Manuale d'Uso e Manutenzione: € 40,00 + spese di spedizione.

MOD165V01 - FINITO DI STAMPARE NEL SETTEMBRE 2023

EN

**PACKAGING COSTS:** included in the price for equipment; for spare parts and accessories there is a charge of € 8.00.

**FIXED COST OF ORDER MANAGEMENT:** € 10.00 only on orders of less than € 100.00.

**ORDERS:** Orders must be transmitted in written form only; new orders or any changes transmitted in verbal form will not be accepted.

**PAYMENT TERMS:** Payment by bank transfer is required for: 1. First deliveries. - 2. On exceeding the credit limit. - 3. Shipment of spare parts.

**PAYMENT DEFERRALS:** To be defined.

Interest at the legal rate shall be charged on sums paid late with respect to the agreed due date. Any credit notes will be deducted from the next invoice.

**PRICES:** these are not binding, they may vary without prior notice, in which case they will be confirmed on the order. Prices are VAT excluded.

**DELIVERY TERMS:** 1. For Italy, possible shipment within 24 hours for machines in stock. 2. For machines to be produced, please allow approximately 25 days, barring unforeseen circumstances.

**SHIPMENT:** EX WORKS, goods travel at the customer's risk, therefore Fimar S.p.a. is not responsible for any damage suffered by the goods during transport. Any claims must be made at the time of delivery within the legal terms.

**TECHNICAL ASSISTANCE:** charged to the dealer for the entire duration of the warranty of one year. Fimar S.p.a. undertakes to supply, under warranty, all spare parts deemed defective. The sales price invoiced to the end user shall include not only the price of the finished products sold, but also the dealer's handling of the warranty covering them. Fimar S.p.a. shall not incur any direct or indirect expenses borne by the retailer for the management of the warranty. The warranty shall be void if the product is damaged or impaired by incorrect or otherwise non-compliant use.

**INSTALLATION:** installation and instruction in the use of the machine and its accessories are the responsibility of the dealer.

**REPAIRS:** in the event that a repair quote is not accepted, € 25.00 will be charged as a contribution towards operating costs.

**WARRANTY:** 12 months.

**RETURNS:** for any authorised returns of goods with undamaged packaging, a fee of 15% of the value will be withheld, with a minimum of € 50.

**INSURANCE:** all our machines are covered by insurance (third party liability) Excluding U.S.A. and CANADA.

**CATALOGUE:** this document invalidates all previous ones. The technical data, illustrations and pictures in this document are purely indicative. The Company reserves the right to modify the technical and aesthetic characteristics or discontinue its production at any time without prior notice.

**IMAGES AND ILLUSTRATIONS:** All images taken by the manufacturer are covered by copyright. Their use or reproduction is subject to authorisation by the company that owns the trademark and holds the material and intellectual property rights. Prices or technical data may be subject to change in the event of typographical errors or changes.

**TRADEMARK AND PATENTS:** It is expressly forbidden to use the trademarks and/or patents registered by Fimar S.p.a.. Please note that all machinery and accessories that are not CE marked have specific characteristics that make them unsuitable for sale within the countries of the European Union.

**REQUEST FOR ADDITIONAL TECHNICAL DOCUMENTATION:** Copy conforming to the original of the CE Certification: € 20.00 + shipping costs - Hard copy of the Use and Maintenance Manual: € 40.00 + shipping costs.

MOD165V01 - PRINTED IN SEPTEMBER 2023

FR

**FRAIS D'EMBALLAGE:** inclus dans le prix pour les machines; pour les pièces détachées et les accessoires, il y a un supplément de € 8,00.

**FRAIS FIXES DE GESTION DES COMMANDES:** 10,00 € uniquement pour les commandes inférieures à 100,00 €.

**COMMANDES:** Les commandes doivent être transmises uniquement par écrit; les nouvelles commandes ou les modifications transmises oralement ne seront pas acceptées.

**CONDITIONS DE PAIEMENT:** Le paiement par virement bancaire est exigé pour: 1. les premières livraisons - 2. en cas de dépassement de la limite de crédit - 3. L'envoi de pièces détachées.

**RETARDS DE PAIEMENT:** à définir.

Les sommes payées en retard par rapport à la date d'échéance convenue sont majorées d'un intérêt au taux légal. Les avoirs éventuels seront déduits de la facture suivante.

**PRIX:** ils ne sont pas contractuels, ils peuvent varier sans préavis, auquel cas ils seront confirmés lors de la commande. Tous les prix s'entendent hors TVA.

**CONDITIONS DE LIVRAISON:** 1) Pour l'Italie, expédition possible dans les 24 heures pour les machines en stock. 2) Pour les machines à produire, il faut compter environ 25 jours, sauf imprévus.

**TRANSPORT:** EX WORKS, la marchandise voyage aux risques et périls du client, par conséquent Fimar S.p.a. n'est pas responsable des éventuels dommages subis par la marchandise pendant le transport. Toute réclamation doit être faite au moment de la livraison dans les délais légaux.

**ASSISTANCE TECHNIQUE:** à la charge du revendeur pendant toute la durée de la garantie d'un an. Fimar S.p.a. s'engage à fournir, sous garantie, toutes les pièces de rechange jugées défectueuses. Le prix de vente facturé à l'utilisateur final comprend non seulement le prix des produits finis vendus, mais aussi la prise en charge par le revendeur de la garantie qui les couvre. Fimar S.p.a. ne supportera pas les frais directs ou indirects encourus par le revendeur pour la gestion de la garantie. La garantie est annulée si le produit est endommagé ou détérioré à la suite d'une utilisation incorrecte ou non conforme.

**INSTALLATION:** l'installation et la formation à l'utilisation de l'appareil et de ses accessoires sont à la charge du revendeur.

**RÉPARATIONS:** en cas de refus d'un devis de réparation, 25,00 € seront facturés à titre de participation aux frais d'exploitation.

**GARANTIE:** 12 mois.

**RETOURS:** pour tout retour autorisé de marchandises dans un emballage intact, une retenue de 15% de la valeur sera effectuée, avec un minimum de 50 €.

**ASSURANCE:** toutes nos machines sont couvertes par une assurance (responsabilité civile), à l'exclusion des États-Unis et du Canada.

**CATALOGUE LISTE:** Ce document annule tous les documents précédents. Les données techniques, les illustrations et les photos contenues dans ce document sont purement indicatives. La société se réserve le droit de modifier les caractéristiques techniques et esthétiques ou d'arrêter la production à tout moment et sans préavis.

**IMAGES ET ILLUSTRATIONS:** Toutes les images prises par le fabricant sont couvertes par le droit d'auteur. Leur utilisation ou leur reproduction est soumise à l'autorisation de la société propriétaire de la marque et détentrice des droits matériels et de propriété intellectuelle. Les prix ou les données techniques peuvent être modifiés en cas d'erreurs typographiques ou de changements.

**MARQUES ET BREVETS:** Il est expressément interdit d'utiliser les marques et/ou les brevets déposés par Fimar S.p.a.. Il est à noter que les machines et les accessoires non marqués CE présentent des caractéristiques spécifiques qui les rendent impropres à la vente dans les pays de l'Union européenne.

**DEMANDE DE DOCUMENTATION TECHNIQUE SUPPLÉMENTAIRE:** Copie conforme à l'original de la certification CE: 20,00 € + frais d'expédition - Copie papier du manuel d'utilisation et d'entretien: 40,00 € + frais d'expédition.

MOD165V01 - IMPRESSION TERMINÉE EN SEPTEMBRE 2023

## DE

**VERPACKUNGSKOSTEN:** für Maschinen im Preis inbegriffen; für Ersatzteile und Zubehör wird eine Gebühr von 8,00 € erhoben.

**FESTE KOSTEN FÜR DIE BESTELLUNGSVERWALTUNG:** 10,00 € nur für Bestellungen unter 100,00 €.

**AUFTRÄGE:** Aufträge sind ausschließlich in schriftlicher Form zu übermitteln; mündlich übermittelte Neuaufträge oder Änderungen werden nicht angenommen.

**ZAHLUNGSBEDINGUNGEN:** Die Zahlung per Banküberweisung ist erforderlich: 1. bei der ersten Lieferung. - 2. bei Überschreitung des Kreditlimits. - 3. bei Versand von Ersatzteilen.

**ZAHLUNGSVERZÖGERUNGEN:** zu bestimmen.

Auf verspätet gezahlte Beträge werden Verzugszinsen in Höhe des gesetzlichen Zinssatzes erhoben. Eventuelle Gutschriften werden mit der nächsten Rechnung verrechnet.

**PREISE:** Sie sind unverbindlich und können ohne vorherige Ankündigung geändert werden; in diesem Fall werden sie auf der Bestellung bestätigt. Alle Preise verstehen sich ohne Mehrwertsteuer.

**LIEFERBEDINGUNGEN:** 1. für Italien, möglicher Versand innerhalb von 24 Stunden für Geräte auf Lager. 2) Für Geräte, die hergestellt werden sollen, beträgt die Lieferzeit etwa 25 Tage, sofern keine unvorhergesehenen Umstände eintreten.

**TRANSPORT:** AB WERK, die Ware reist auf Risiko des Kunden, daher ist Fimar S.p.a. nicht für eventuelle Schäden an der Ware während des Transports verantwortlich. Eventuelle Reklamationen müssen zum Zeitpunkt der Lieferung innerhalb der gesetzlichen Fristen geltend gemacht werden.

**TECHNISCHE UNTERSTÜTZUNG:** zu Lasten des Händlers für die gesamte Dauer der Garantie von einem Jahr. Fimar S.p.a. verpflichtet sich, im Rahmen der Garantie alle Ersatzteile zu liefern, die als defekt gelten. Der dem Endverbraucher in Rechnung gestellte Verkaufspreis umfasst nicht nur den Preis für die verkauften Endprodukte, sondern auch die Abwicklung der Garantie durch den Händler. Fimar S.p.a. übernimmt keine direkten oder indirekten Kosten, die dem Wiederverkäufer durch die Abwicklung der Garantie entstehen. Die Garantie erlischt, wenn das Produkt durch unsachgemäßen oder anderweitig nicht konformen Gebrauch beschädigt oder beeinträchtigt wird.

**INBETRIEBNAHME:** Die Inbetriebnahme und die Einweisung in den Gebrauch des Geräts und seines Zubehörs liegen in der Verantwortung des Händlers.

**REPARATUREN:** Falls ein Kostenvorschlag für eine Reparatur nicht akzeptiert wird, werden 25,00 € als Beitrag zu den Betriebskosten berechnet.

**GARANTIE:** 12 Monate.

**RÜCKGABE:** Für jede genehmigte Rücksendung von Waren mit unbeschädigter Verpackung wird eine Gebühr von 15 % des Wertes einbehalten, mindestens jedoch 50 €.

**VERSICHERUNG:** Alle unsere Geräte sind versichert (Haftpflicht), ausgenommen USA und KANADA.

**KATALOG-PREISLISTE:** Dieses Dokument ersetzt alle vorherigen Dokumente. Die technischen Daten, Illustrationen und Bilder in diesem Dokument sind rein indikativ. Das Unternehmen behält sich das Recht vor, die technischen und ästhetischen Merkmale zu ändern oder die Produktion jederzeit und ohne Vorankündigung einzustellen.

**BILDER UND ILLUSTRATIONEN:** Alle vom Hersteller aufgenommenen Bilder sind urheberrechtlich geschützt. Ihre Verwendung oder Vervielfältigung unterliegt der Genehmigung des Unternehmens, das Eigentümer der Marke und Inhaber der materiellen und geistigen Eigentumsrechte ist. Preise oder technische Daten können im Falle von Druckfehlern oder Änderungen geändert werden.

**MARKEN UND PATENTE:** Es ist ausdrücklich verboten, die von Fimar S.p.a. eingetragenen Marken und/oder Patente zu verwenden. Wir weisen darauf hin, dass alle Maschinen und Zubehörteile, die nicht mit der CE-Kennzeichnung versehen sind, besondere Merkmale aufweisen, die sie für den Verkauf in den Ländern der Europäischen Union ungeeignet machen.

**ANFORDERUNG VON ZUSÄTZLICHEN TECHNISCHEN DOKUMENTEN:** Kopie, die dem Original der CE-Zertifizierung entspricht: € 20,00 + Versandkosten - Ausdruck der Bedienungs- und Wartungsanleitung: € 40,00 + Versandkosten.

MOD165V01 - FDRUCKFERTIGSTELLUNG IM SEPTEMBER 2023

## ES

**GASTOS DE EMBALAJE:** incluidos en el precio de las máquinas; para las piezas de recambio y los accesorios se aplica un recargo de 8,00 €.

**GASTOS FIJOS DE GESTIÓN DE PEDIDOS:** 10,00 euros sólo para pedidos inferiores a 100,00 euros.

**PEDIDOS:** Los pedidos deben transmitirse únicamente por escrito; no se aceptarán nuevos pedidos ni modificaciones transmitidas verbalmente.

**CONDICIONES DE PAGO:** El pago por transferencia bancaria es obligatorio para: 1. Primeras entregas. - 2. Al superar el límite de crédito. - 3. Envío de piezas de recambio.

**ATRASOS EN EL PAGO:** A definir.

Se cobrarán intereses al tipo legal sobre las cantidades pagadas con retraso respecto a la fecha de vencimiento acordada. Los abonos se descontarán de la siguiente factura.

**PRECIOS:** no son vinculantes, pueden variar sin previo aviso, en cuyo caso se confirmarán en el pedido. Todos los precios son sin IVA.

**PLAZOS DE ENTREGA:** 1. Para Italia, envío posible en 24 horas para las máquinas en stock. 2. Para las máquinas que deben fabricarse, prevea un plazo aproximado de 25 días, salvo imprevistos.

**TRANSPORTE:** FRANCO DE PORTE, la mercancía viaja por cuenta y riesgo del cliente, por lo que Fimar S.p.a. no se hace responsable de los posibles daños sufridos por la mercancía durante el transporte. Cualquier reclamación deberá efectuarse en el momento de la entrega dentro de los plazos legales.

**ASISTENCIA TÉCNICA:** a cargo del concesionario durante toda la duración de la garantía de un año. Fimar S.p.a. se compromete a suministrar, en garantía, todas las piezas de recambio consideradas defectuosas. El precio de venta facturado al usuario final incluirá no sólo el precio de los productos acabados vendidos, sino también la gestión por parte del concesionario de la garantía que los cubre. Fimar S.p.a. no incurrirá en ningún gasto directo o indirecto ocasionado al revendedor por la gestión de la garantía. La garantía quedará anulada si el producto resulta dañado o perjudicado por un uso incorrecto o no conforme.

**INSTALACIÓN:** la instalación y la instrucción en el uso de la máquina y sus accesorios son responsabilidad del distribuidor.

**REPARACIONES:** en caso de que no se acepte un presupuesto de reparación, se cobrarán 25,00 euros como contribución a los gastos de funcionamiento.

**GARANTÍA:** 12 meses.

**DEVOLUCIONES:** para cualquier devolución autorizada de mercancía con el embalaje intacto, se deducirá una tasa del 15% del valor, con un mínimo de 50 euros.

**SEGURO:** todas nuestras máquinas están cubiertas por un seguro (responsabilidad civil), excepto EE.UU. y CANADA.

**CATÁLOGO/LISTA:** este documento anula todos los anteriores. Los datos técnicos, ilustraciones y fotografías que figuran en este documento son puramente indicativos. La Empresa se reserva el derecho de modificar las características técnicas y estéticas o de interrumpir su producción en cualquier momento sin previo aviso.

**IMÁGENES E ILUSTRACIONES:** Todas las imágenes tomadas por el fabricante están protegidas por derechos de autor. Su utilización o reproducción está sujeta a la autorización de la empresa propietaria de la marca y titular de los derechos materiales y de propiedad intelectual. Los precios o datos técnicos pueden estar sujetos a modificaciones en caso de errores tipográficos o cambios.

**MARCAS Y PATENTES:** Queda expresamente prohibida la utilización de las marcas y/o patentes registradas por Fimar S.p.a. Se recuerda que todas las máquinas y accesorios que no llevan el marcado CE tienen características específicas que los hacen inadecuados para la venta en los países de la Unión Europea.

**SOLICITUD DE DOCUMENTACIÓN TÉCNICA ADICIONAL:** Copia conforme al original de la Certificación CE: 20,00 € + gastos de envío - Copia impresa del Manual de Uso y Mantenimiento: 40,00 € + gastos de envío.

MOD165V01 - ACABADO DE IMPRIMIR EN SEPTIEMBRE DE 2023

## RU

**RASCHODY NA UPAKOVKU:** включены в стоимость машин; за запасные части и принадлежности взимается плата в размере € 8,00.

**ФИКСИРОВАННАЯ СТОИМОСТЬ УПРАВЛЕНИЯ ЗАКАЗОМ:** € 10,00 только для заказов на сумму менее € 100,00.

**ЗАКАЗЫ:** Заказы должны передаваться только в письменной форме; новые заказы или любые изменения, переданные в устной форме, не принимаются.

**УСЛОВИЯ ОПЛАТЫ:** Оплата банковским переводом требуется для: 1. при первых поставках. - 2. при превышении кредитного лимита. - 3. Отгрузки запасных частей.

**ОТЛОЖЕНИЯ ОПЛАТЫ:** определяются дополнительно.

На суммы, выплаченные с опозданием по отношению к оговоренной дате платежа, начисляются проценты по установленной законом ставке. Любые кредитные ноты будут вычитаться из следующего счета-фактуры.

**ЦЕНЫ:** цены не являются обязательными, они могут изменяться без предварительного уведомления, в этом случае они будут подтверждены в заказе. Все цены указаны без учета НДС.

**УСЛОВИЯ ДОСТАВКИ:** 1. Для Италии возможна отгрузка в течение 24 часов для станков, имеющихся на складе. 2. для машин, которые должны быть произведены, пожалуйста, приготовьте примерно 25 дней, за исключением непредвиденных обстоятельств.

**ТРАНСПОРТИРОВКА:** БЕСПЛАТНАЯ ДОСТАВКА, товар перевозится на риск покупателя, поэтому Fimar S.p.a. не несет ответственности за любой ущерб, нанесенный товару во время транспортировки. Любые претензии должны быть предъявлены в момент доставки в рамках установленных законом сроков.

**ТЕХНИЧЕСКОЕ ОБСЛУЖИВАНИЕ:** оплачивается дилером в течение всего срока действия гарантии, составляющего один год. Fimar S.p.a. обязуется поставлять по гарантии все запасные части, признанные дефектными. В цену продажи, выставленную конечному пользователю, включается не только стоимость проданных готовых изделий, но и расходы дилера на гарантийное обслуживание этих изделий. Компания Fimar S.p.a. не несет никаких прямых или косвенных расходов, понесенных торговым представителем в связи с управлением гарантией. Гарантия теряет силу, если изделие повреждено или вышло из строя в результате неправильного или иного несоответствующего использования.

**УСТАНОВКА:** за установку и инструктаж по эксплуатации машины и ее принадлежностей отвечает дилер.

**РЕМОНТ:** в случае неприятия сметы на ремонт взимается 25,00 евро в качестве взноса на эксплуатационные расходы.

**ГАРАНТИЯ:** 12 месяцев.

**ВОЗВРАТ:** за любой разрешенный возврат товара с неповрежденной упаковкой удерживается сбор в размере 15% от стоимости, минимальная сумма составляет € 50.

**СТРАХОВАНИЕ:** все наши машины застрахованы (ответственность перед третьими лицами), за исключением США и Канады.

**КАТАЛОГ/ПЕРЕЧЕНЬ:** данный документ отменяет все предыдущие. Технические данные, иллюстрации и фотографии, приведенные в данном документе, являются исключительно ориентировочными. Компания оставляет за собой право изменять технические и эстетические характеристики или прекращать его производство в любое время без предварительного уведомления.

**ИЗОБРАЖЕНИЯ И ИЛЛЮСТРАЦИИ:** Все изображения, сделанные производителем, защищены авторским правом. Их использование или воспроизведение осуществляется с разрешения компани- владельца товарного знака и прав на материалы и интеллектуальную собственность. Цены или технические данные могут быть изменены в случае опечаток или изменений.

**ТОРГОВЫЕ ЗНАКИ И ПАТЕНТЫ:** Категорически запрещается использовать торговые марки и/или патенты, зарегистрированные компанией Fimar S.p.a. Обратите внимание, что все машины и принадлежности, не имеющие маркировки CE, обладают специфическими характеристиками, которые делают их непригодными для продажи на территории стран Европейского Союза.

**ЗАПРОС ДОПОЛНИТЕЛЬНОЙ ТЕХНИЧЕСКОЙ ДОКУМЕНТАЦИИ:** Копия, соответствующая оригиналу сертификации CE: € 20,00 + стоимость доставки - Твердая копия руководства по эксплуатации и техническому обслуживанию: € 40,00 + стоимость доставки.

MOD165V01 - ГОТОВО К ПЕЧАТИ В СЕНТЯБРЕ 2023



# Lavorazione carne

MEAT PROCESSING  
TRAITEMENT DE LA VIANDE  
FLEISCHCERARBEITUNG  
PROCESAMIENTO DE CARNE  
ПЕРЕРАБОТКА МЯСА

## IT

Primo macchinario progettato e realizzato da Fimar nel 1979, è il Tritacarne che oggi troviamo in diverse dimensioni, abbinato con la grattugia o nella sua ultima versione anche refrigerato.

I macchinari sono tutti Made in Italy studiati per le esigenze di ristoranti, macellerie non industriali e supermercati.

Completano la categoria lavorazione della carne: Grattugie, Segaoossi Anodizzati o Verniciati, Impastatrici per Carne, Insaccatrici Manuali e Pressamburger.

## EN

The first machine designed and manufactured by Fimar in 1979, was the Meat Mincer today presented in different sizes, combined with a grater or in its latest version: refrigerated.

All of our machines are Made in Italy and have been designed to satisfy restaurants, non-industrial butchers and supermarkets needs.

The meat processing category is completed by: Graters, Anodized or Painted Bone Bandsaw, Meat Mixers, Manual Sausage Fillers and Hamburger Presses.

## FR

La première machine conçue et fabriquée par Fimar en 1979, a été le hachoir à viande aujourd'hui présenté en différentes tailles, combiné avec une râpe ou dans la dernière version réfrigérée.

Toutes nos machines sont fabriquées en Italie et ont été conçues pour satisfaire les besoins des restaurants, des boucheries artisanales et des supermarchés.

La catégorie "transformation de la viande" est complétée par: Râpes, Scie à os Anodisée ou Peinte, Mélangeurs de viande, Pousseurs Manuels à saucisses et Presses à hamburger.

## DE

Das erste Gerät, das im Jahr 1979 von Fimar entwickelt und hergestellt wurde, ist der Fleischwolf, heute verfügbar in verschiedenen Größen, kombiniert mit Reibe oder in seiner neuesten Version: gekühlt.

Alle unsere Maschinen sind „Made in Italy“ und wurden entwickelt, um die Bedürfnisse von Restaurants, kleinen Metzgereien und Supermärkten zu erfüllen.

Die Kategorie der Fleischverarbeitung ist durch Reiben, eloxierte oder lackierte Knochenbandsäge, Fleischmischer, manuelle Wurstfüllmaschinen und Hamburgerpressen ergänzt.

## ES

La primera máquina diseñada y fabricada por Fimar en 1979, fue la Picadora de Carne que hoy se presenta en diferentes tamaños, combinada con un rallador o en la última versión refrigerada.

Todas nuestras máquinas son Made in Italy y han sido diseñadas para satisfacer las necesidades de restaurantes, carnicerías artesanales y supermercados.

La categoría de procesamiento de carne se completa con: Ralladoras, Sierra de cinta para huesos anodizada o pintada, Mezcladoras de carne, llenadoras manuales de salchichas y Presas para hamburguesas.

## RU

Первой машиной, разработанной и изготовленной Fimar в 1979 году, стала мясорубка, представленная сегодня в различных размерах, в сочетании с теркой или в последней версии: холодильной.

Все наши машины Сделаны в Италии и разработаны для удовлетворения потребностей ресторанов, непромышленных мясников и супермаркетов.

Категория мясopереработки завершается: Терка, Анодированная или окрашенная костная ленточная пила, Мешалки для мяса, Ручные дозаторы колбасы и Гамбургерные Прессы.

# 22REFI 32REFI



## Tritacarne refrigerati

REFRIGERATED MEAT MINCER  
HACHOIR À VIANDE RÉFRIGÉRÉ  
GEKÜHLTER FLEISHWOLF  
PICADORA DE CARNE REFRIGERADA  
ОХЛАЖДАЕМАЯ МЯСОРУБКА



IT Ideale per laboratori di macelleria di medie dimensioni, supermercati e per la ristorazione. Refrigerazione della tramoggia, del collo di alimentazione e del gruppo di macinazione - **bocca ingresso carne 22REFI ø 52 mm - bocca ingresso carne 32REFI ø 80 mm** - temperatura di lavoro +4° - tramoggia fissa - grande versatilità in dimensioni compatte - gruppo di macinazione e struttura in acciaio inox AISI 304 - comandi frontali - bloccaggio gruppo di macinazione laterale - inversione di marcia.







EN Perfect for medium-sized butcher's shops, supermarkets and restaurants. Refrigerated hopper, feeding neck and grinding unit - **meat inlet 22REFI ø 52 mm - meat inlet 32REFI ø 80 mm** - operating temperature + 4° - static hopper - great versatility in compact dimensions - grinding unit and casing in stainless steel AISI 304 - frontal controls - grinding unit side locking - reverse function.

FR Parfait pour les boucheries, supermarchés et restaurants de taille moyenne. Trémie, orifice d'alimentation et groupe de hachage réfrigérée - **orifice d'entrée viande 22REFI ø 52 mm - orifice d'entrée viande 32REFI ø 80 mm** - température de service + 4° - trémie fixe - flexibilité élevée dans des dimensions compactes - groupe de hachage et corps en acier inox AISI 304 - commandes frontales - verrouillage du groupe de hachage latéral - inversion de marche.

DE Die ideale Lösung für mittelgroße Metzgereien, Supermärkte und Restaurants. Trichter, Fleischeinführöffnung und Zerkleinerungseinheit gekühlt - **Fleischeinführöffnung 22REFI ø 52 mm - Fleischeinführöffnung 32REFI ø 80 mm** - Betriebstemperatur + 4° - stationärer Trichter - große Vielseitigkeit bei kompakten Maßen - Gehäuse und Zerkleinerungseinheit aus Edelstahl AISI 304 - frontseitige Bedienelemente - seitliche Verriegelung der Zerkleinerungseinheit - Umkehrgetriebe.

ES Ideal para carnicerías, supermercados y restaurantes de tamaño medio. Tolva, cuello de alimentación y grupo de picar refrigerado - **boca para introducir la carne 22REFI de ø 52 mm - boca para introducir la carne 32REFI de ø 80 mm** - temperatura de trabajo + 4° - tolva fija - gran versatilidad en dimensiones compactas - grupo de picar y carcasa de acero inoxidable AISI 304 - controles frontales - bloqueo lateral de la unidad de picar - inversión de marcha.

RU Идеальное решение для средних мясных магазинов, супермаркетов и ресторанов. Охлаждаемые воронка, мясоприемник и узел измельчения - **мясоприемник 22REFI с горловиной ø 52 мм - мясоприемник 32REFI с горловиной ø 80 мм** - рабочая температура + 4° - стационарная воронка - высокая гибкость в эксплуатации и компактные размеры - корпус и узел измельчения из нержавеющей стали AISI 304 - панель управления на лицевой стороне - боковая фиксация узла измельчения - Реверс.

	22REFI	32REFI
	1,1 kW (1,5 HP)	1,87 kW (2,54 HP)
	230-400V/3N/50Hz	230-400V/3N/50-60Hz
	230V/1N/50Hz	-
	150÷250 Kg/h	300÷500 Kg/h
	R134a	
	270 x 410 x 545(h) mm	350 x 530 x 555(h) mm
		
	43 Kg	56 Kg
	48 Kg	61 Kg
	760 x 600 x 770(h) mm	
	0,351 m³	

# 32TN



76 mm

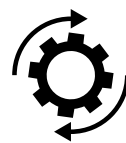

Inversione di marcia  
Function reverse  
Реверс



3 HP



# Tritacarne

MEAT MINCER  
HACHOIR À VIANDE  
FLEISCHWOLF  
PICADORE DE CARNE  
МЯСОРУБКА

IT Carcassa e tramoggia in acciaio inox. Macchina con gruppo di macinazione completamente removibile che permette di poterlo collocare in frigorifero - il gruppo di macinazione in acciaio inox AISI 304 può essere lavato in lavastoviglie - ventola di raffreddamento - **bocca ingresso carne ø 76 mm** - microinterruttori di sicurezza su tramoggia - **inversione di marcia** - riduttore con ingranaggi a bagno d'olio - in dotazione sistema enterprise con piastra inox (fori ø 6 mm) e coltello inox autoaffilante.

EN Stainless steel casing and hopper. Machine with a completely removable grinding unit that allows it to be placed in the refrigerator - hygiene standards - the grinding unit in stainless steel AISI 304 can be washed in the dishwasher - cooling fan - **meat inlet ø 76 mm** - safety microswitches on the hopper - **reverse function** - oiled gear motor - equipped with enterprise system with stainless steel plate (holes ø 6 mm) and self-sharpening stainless steel knife.

FR Corps et trémie en acier inox. Machine avec groupe de hachage entièrement amovible qui permet de pouvoir le placer dans le réfrigérateur - l'unité de broyage en acier inox AISI 304 peut être lavée au lave-vaisselle - ventilateur de refroidissement - **orifice d'entrée viande ø 76 mm** - **inversion de marche** - micro-interrupteurs de sécurité sur la trémie - motomoteur réducteur à engrenages à bain d'huile. De série, système enterprise avec plaque en inox (trous ø 6 mm) et couteau inox aiguisement automatique.

DE Gehäuse und Trichter aus Edelstahl. Maschine mit Zerkleinerungseinheit, die vollständig abnehmbar ist und daher die Aufbewahrung im Kühlschrank gestattet. Hygienevorschriften von den Hackfleischrückständen gereinigt zu werden, die Zerkleinerungseinheit aus Edelstahl AISI 304 kann in der Geschirrspülmaschine gereinigt werden. Kühllüfter - **Fleischeinlassöffnung ø 76 mm** - Sicherheitsmikroschalter am Trichter - **Umkehrgetriebe** - Getriebemotor mit Ölbad - ausgestattet mit Enterprise System mit Edelstahlplatte (Löcher ø 6 mm) und selbstschärfendem Edelstahlmesser.

ES Carcasa y tolva de acero inoxidable. Máquina con grupo de picar completamente extraíble que permite poderlo colocar en la nevera. El grupo de picar de acero inoxidable AISI 304 puede ser limpiado en el lavavajillas - ventilador de enfriamiento - **boca de ø 76 mm para introducir la carne** - microinterruptores de seguridad en la tolva - **inversión de marcha** - reductor con engranajes en baño de aceite - en dotación sistema enterprise con placa de acero inoxidable (agujeros ø 6 mm) y cuchilla de acero inoxidable con autoafilado.

RU Корпус и воронка из нержавеющей стали. Машина с полностью съемным измельчающим устройством, которое может храниться в холодильнике без предварительной очистки от мясного фарша после каждого использования в соответствии с гигиеническими нормами HACCP, узел измельчения из нержавеющей стали AISI 304 можно мыть в посудомоечной машине. Охлаждающий вентилятор - **Мясоприемник ø 76 мм** - Предохранительный микровыключатель на воронке - **Реверс** - Привод с масляной ванной - Система Enterprise с решеткой из нержавеющей стали (отверстия ø 6 мм) и самозатачивающимся ножом из нержавеющей стали.

	<b>32TN</b>	
	2,2 kW (3 HP)	
	230-400V/3N/50Hz	
	230V/1N/50Hz	
	300+500 Kg/h	
	520 x 320 x 550(h) mm	
		
	 53 Kg	 43 Kg
	 59 Kg	 49 Kg
	570 x 420 x 680(h) mm	
	0,163 m³	

# 32TND

New



76 mm

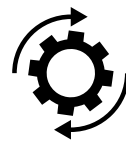

Inversione di marcia  
Function reverse  
Реверс



2,2 HP



# Tritacarne

MEAT MINCER  
HACHOIR À VIANDE  
FLEISCHWOLF  
PICADORE DE CARNE  
МЯСОРУБКА

IT Carcassa e tramoggia in acciaio inox. Macchina con gruppo di macinazione completamente removibile che permette di poterlo collocare in frigorifero - il gruppo di macinazione in acciaio inox AISI 304 può essere lavato in lavastoviglie - ventola di raffreddamento - **bocca ingresso carne ø 76 mm** - microinterruttori di sicurezza su tramoggia - **inversione di marcia** - riduttore con ingranaggi a bagno d'olio - in dotazione sistema enterprise con piastra inox (fori ø 6 mm) e coltello inox autoaffilante.

EN Stainless steel casing and hopper. Machine with a completely removable grinding unit that allows it to be placed in the refrigerator - hygiene standards - the grinding unit in stainless steel AISI 304 can be washed in the dishwasher - cooling fan - **meat inlet ø 76 mm** - safety microswitches on the hopper - **reverse function** - oiled gear motor - equipped with enterprise system with stainless steel plate (holes ø 6 mm) and self-sharpening stainless steel knife.

FR Corps et trémie en acier inox. Machine avec groupe de hachage entièrement amovible qui permet de pouvoir le placer dans le réfrigérateur - l'unité de broyage en acier inox AISI 304 peut être lavée au lave-vaisselle - ventilateur de refroidissement - **orifice d'entrée viande ø 76 mm** - **inversion de marche** - micro-interrupteurs de sécurité sur la trémie - motomoteur réducteur à engrenages à bain d'huile. De série, système enterprise avec plaque en inox (trous ø 6 mm) et couteau inox aiguisement automatique.

DE Gehäuse und Trichter aus Edelstahl. Maschine mit Zerkleinerungseinheit, die vollständig abnehmbar ist und daher die Aufbewahrung im Kühlschrank gestattet. Hygienevorschriften von den Hackfleischrückständen gereinigt zu werden, die Zerkleinerungseinheit aus Edelstahl AISI 304 kann in der Geschirrspülmaschine gereinigt werden. Kühllüfter - **Fleischeinlassöffnung ø 76 mm** - Sicherheitsmikroschalter am Trichter - **Umkehrgetriebe** - Getriebemotor mit Ölbad - ausgestattet mit Enterprise System mit Edelstahlplatte (Löcher ø 6 mm) und selbstschärfendem Edelstahlmesser.

ES Carcasa y tolva de acero inoxidable. Máquina con grupo de picar completamente extraíble que permite poderlo colocar en la nevera. El grupo de picar de acero inoxidable AISI 304 puede ser limpiado en el lavavajillas - ventilador de enfriamiento - **boca de ø 76 mm para introducir la carne** - microinterruptores de seguridad en la tolva - **inversión de marcha** - reductor con engranajes en baño de aceite - en dotación sistema enterprise con placa de acero inoxidable (agujeros ø 6 mm) y cuchilla de acero inoxidable con autoafilado.

RU Корпус и воронка из нержавеющей стали. Машина с полностью съемным измельчающим устройством, которое может храниться в холодильнике без предварительной очистки от мясного фарша после каждого использования в соответствии с гигиеническими нормами HACCP, узел измельчения из нержавеющей стали AISI 304 можно мыть в посудомоечной машине. Охлаждающий вентилятор - **Мясоприемник ø 76 мм** - Предохранительный микровыключатель на воронке - **Реверс** - Привод с масляной ванной - Система Enterprise с решеткой из нержавеющей стали (отверстия ø 6 мм) и самозатачивающимся ножом из нержавеющей стали.

	<b>32TND</b>	
	1,6 kW (2,2 HP)	
	230-400V/3N/50Hz	
	230V/1N/50Hz	
	300+500 Kg/h	
	520 x 320 x 550(h) mm	
		
	 41 Kg	 39 Kg
	 46 Kg	 44 Kg
	570 x 420 x 680(h) mm	
	0,163 m³	

# 32TNE

New



76 mm



2,2 HP



# Tritacarne

MEAT MINCER  
HACHOIR À VIANDE  
FLEISCHWOLF  
PICADORE DE CARNE  
МЯСОРУБКА

IT Carcassa e tramoggia in acciaio inox. Macchina con gruppo di macinazione completamente removibile che permette di poterlo collocare in frigorifero - il gruppo di macinazione in acciaio inox AISI 304 può essere lavato in lavastoviglie - ventola di raffreddamento - **bocca ingresso carne ø 76 mm** - microinterruttori di sicurezza su tramoggia - riduttore con ingranaggi a bagno d'olio - in dotazione sistema enterprise con piastra inox (fori ø 6 mm) e coltello inox autoaffilante.

EN Stainless steel casing and hopper. Machine with a completely removable grinding unit that allows it to be placed in the refrigerator - hygiene standards - the grinding unit in stainless steel AISI 304 can be washed in the dishwasher - cooling fan - **meat inlet ø 76 mm** - safety microswitches on the hopper - oiled gear motor - equipped with enterprise system with stainless steel plate (holes ø 6 mm) and self-sharpening stainless steel knife.

FR Corps et trémie en acier inox. Machine avec groupe de hachage entièrement amovible qui permet de pouvoir le placer dans le réfrigérateur - l'unité de broyage en acier inox AISI 304 peut être lavée au lave-vaisselle - ventilateur de refroidissement - **orifice d'entrée viande ø 76 mm** - micro-interrupteurs de sécurité sur la trémie - motomoteur réducteur à engrenages à bain d'huile. De série, système enterprise avec plaque en inox (trous ø 6 mm) et couteau inox aiguisement automatique.

DE Gehäuse und Trichter aus Edelstahl. Maschine mit Zerkleinerungseinheit, die vollständig abnehmbar ist und daher die Aufbewahrung im Kühlschrank gestattet. Hygienevorschriften von den Hackfleischrückständen gereinigt zu werden, die Zerkleinerungseinheit aus Edelstahl AISI 304 kann in der Geschirrspülmaschine gereinigt werden. Kühl Lüfter - **Fleischeinlassöffnung ø 76 mm** - Sicherheitsmikroschalter am Trichter - Getriebemotor mit Ölbad - ausgestattet mit Enterprise System mit Edelstahlplatte (Löcher ø 6 mm) und selbstschärfendem Edelmesser.

ES Carcasa y tolva de acero inoxidable. Máquina con grupo de picar completamente extraíble que permite poderlo colocar en la nevera. El grupo de picar de acero inoxidable AISI 304 puede ser limpiado en el lavavajillas - ventilador de enfriamiento - **boca de ø 76 mm para introducir la carne** - microinterruptores de seguridad en la tolva - reductor con engranajes en baño de aceite - en dotación sistema enterprise con placa de acero inoxidable (agujeros ø 6 mm) y cuchilla de acero inoxidable con autoafilado.

RU Корпус и воронка из нержавеющей стали. Машина с полностью съёмным измельчающим устройством, которое может храниться в холодильнике без предварительной очистки от мясного фарша после каждого использования в соответствии с гигиеническими нормами HACCP, узел измельчения из нержавеющей стали AISI 304 можно мыть в посудомоечной машине. Охлаждающий вентилятор - **Мясоприемник ø 76 мм** - Предохранительный микровыключатель на воронке - Привод с масляной ванной - Система Enterprise с решеткой из нержавеющей стали (отверстия ø 6 мм) и самозатачивающимся ножом из нержавеющей стали.

	<b>32TNE</b>	
	1,6 kW (2,2 HP)	
	230-400V/3N/50Hz	
	230V/1N/50Hz	
	300+500 Kg/h	
	520 x 320 x 550(h) mm	
		
	 41 Kg	 39 Kg
	 46 Kg	 44 Kg
	570 x 420 x 680(h) mm	
	0,163 m³	

# 32RS



76 mm



Inversione di marcia  
Function reverse  
Реверс



3 HP



# Tritacarne

MEAT MINCER  
HACHOIR À VIANDE  
FLEISCHWOLF  
PICADORE DE CARNE  
МЯСОРУБКА



IT Carcassa e tramoggia in acciaio inox. Gruppo macinazione estraibile in acciaio inox AISI 304 - ventola di raffreddamento - **bocca ingresso carne ø 76 mm** - microinterruttori di sicurezza su tramoggia - **inversione di marcia** - riduttore con ingranaggi a bagno d'olio. In dotazione sistema enterprise con piastra inox (fori ø 6 mm) e coltello inox autoaffilante.

EN Stainless steel casing and hopper. Removable grinding unit in stainless steel AISI 304 - cooling fan - **meat inlet ø 76 mm** - safety microswitches on the hopper - **reverse function** - oiled gear motor. Equipped with enterprise system with stainless steel plate (holes ø 6 mm) and self-sharpening stainless steel knife.

FR Corps et trémie en acier inox - groupe de hachage amovible en acier inox AISI 304 - ventilateur de refroidissement - **orifice d'entrée viande ø 76 mm** - micro-interrupteurs de sécurité sur la trémie - **inversion de marche** - motoréducteur à engrenages à bain d'huile - de série, système enterprise avec plaque en inox (trous ø 6 mm) et couteau inox aiguisement automatique.

DE Gehäuse und Trichter aus Edelstahl - herausnehmbare Schneidegruppe aus Edelstahl AISI 304 - Kühllüfter - **Fleischeinführöffnung ø 76 mm** - Sicherheitsmikroschalter am Trichter - **Umkehrgetriebe** - Getriebemotor mit Ölbad - ausgestattet mit Enterprise-System mit Edelstahlplatte (Löcher ø 6 mm) und selbstschärfendem Edelmessers.

ES Carcasa y tolva de acero inoxidable - grupo para picar de acero inoxidable AISI 304 extraíble - ventilador de refrigeración - **boca de ø 76 mm para introducir la carne** - microinterruptores de seguridad en la tolva - **inversión de marcha** - reductor con engranajes en baño de aceite. En la dotación sistema enterprise con placa de acero inoxidable (agujeros ø 6 mm) y cuchilla de acero inoxidable con autoafilado.

RU Корпус и воронка из нержавеющей стали - Съёмная режущая группа из нержавеющей стали AISI 304 - Охлаждающий вентилятор - **Мясоприемник ø 76 мм** - Предохранительный микровыключатель на воронке - **Реверс** - Привод с масляной ванной - Система Enterprise с решеткой из нержавеющей стали (отверстия ø 6 мм) и самозатачивающимся ножом из нержавеющей стали.

	<b>32RS</b>	
	2,2 kW (3 HP)	
	230-400V/3N/50Hz	
	230V/1N/50Hz	
	300+500 Kg/h	
	490 x 340 x 530(h) mm	
		
	 53 Kg	 43 Kg
	 59 Kg	 49 Kg
	570 x 420 x 680(h) mm	
	0,163 m³	

# 32RSD

New



76 mm

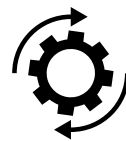

Inversione di marcia  
Function reverse  
Реверс



2,2 HP



# Tritacarne

MEAT MINCER  
HACHOIR À VIANDE  
FLEISCHWOLF  
PICADORE DE CARNE  
МЯСОРУБКА

IT Carcassa e tramoggia in acciaio inox. Gruppo macinazione estraibile in acciaio inox AISI 304 - ventola di raffreddamento - **bocca ingresso carne ø 76 mm** - microinterruttori di sicurezza su tramoggia - **inversione di marcia** - riduttore con ingranaggi a bagno d'olio. In dotazione sistema enterprise con piastra inox (fori ø 6 mm) e coltello inox autoaffilante.

EN Stainless steel casing and hopper. Removable grinding unit in stainless steel AISI 304 - cooling fan - **meat inlet ø 76 mm** - safety microswitches on the hopper - **reverse function** - oiled gear motor. Equipped with enterprise system with stainless steel plate (holes ø 6 mm) and self-sharpening stainless steel knife.

FR Corps et trémie en acier inox - groupe de hachage amovible en acier inox AISI 304 - ventilateur de refroidissement - **orifice d'entrée viande ø 76 mm** - micro-interrupteurs de sécurité sur la trémie - **inversion de marche** - motoréducteur à engrenages à bain d'huile - de série, système enterprise avec plaque en inox (trous ø 6 mm) et couteau inox aiguisement automatique.

DE Gehäuse und Trichter aus Edelstahl - herausnehmbare Schneidegruppe aus Edelstahl AISI 304 - Kühllüfter - **Fleischeinführöffnung ø 76 mm** - Sicherheitsmikroschalter am Trichter- **Umkehrgetriebe** - Getriebemotor mit Ölbad - ausgestattet mit Enterprise-System mit Edelstahlplatte (Löcher ø 6 mm) und selbstschärfendem Edelstahlmesser.

ES Carcasa y tolva de acero inoxidable - grupo para picar de acero inoxidable AISI 304 extraíble - ventilador de refrigeración - **boca de ø 76 mm para introducir la carne** - microinterruptores de seguridad en la tolva - **inversión de marcha** - reductor con engranajes en baño de aceite. En la dotación sistema enterprise con placa de acero inoxidable (agujeros ø 6 mm) y cuchilla de acero inoxidable con autoafilado.

RU Корпус и воронка из нержавеющей стали - Съёмная режущая группа из нержавеющей стали AISI 304 - Охлаждающий вентилятор - **Мясоприемник ø 76 мм** - Предохранительный микровыключатель на воронке - **Реверс** - Привод с масляной ванной - Система Enterprise с решеткой из нержавеющей стали (отверстия ø 6 мм) и самозатачивающимся ножом из нержавеющей стали.

	<b>32RSD</b>	
	1,6 kW (2,2 HP)	
	230-400V/3N/50Hz	
	230V/1N/50Hz	
	300+500 Kg/h	
	490 x 340 x 530(h) mm	
		
	 41 Kg	 39 Kg
	 46 Kg	 44 Kg
	570 x 420 x 680(h) mm	
	0,163 m³	

# 32RSE

New



52 mm



2,2 HP

## Tritacarne

MEAT MINCER  
HACHOIR À VIANDE  
FLEISCHWOLF  
PICADORE DE CARNE  
МЯСОРУБКА

- IT Carcassa e tramoggia in acciaio inox. Gruppo macinazione in acciaio inox AISI 304 estraibile - ventola di raffreddamento - **bocca ingresso carne ø 52 mm** - riduttore con ingranaggi a bagno d'olio. In dotazione sistema enterprice con piastra inox (fori ø 6 mm) e coltello inox autoaffilante.
- EN Stainless steel casing and hopper. Removable grinding unit in stainless steel AISI 304 - cooling fan - **meat inlet ø 52 mm** - oiled gear motor. Equipped with enterprise system with stainless steel plate (holes ø 6 mm) and self-sharpening stainless steel knife.
- FR Corps et trémie en acier inox. Groupe de hachage amovible en acier inox AISI 304 - ventilateur de refroidissement - **orifice d'entrée viande ø 52 mm** - motoréducteur à engrenages à bain d'huile. De série, système enterprice avec plaque en inox (trous ø 6 mm) et couteau inox à aiguisement automatique.
- DE Gehäuse und Trichter aus Edelstahl. Heraunehmbare Zerkleinerungseinheit aus Edelstahl AISI 304 - Kühllüfter - **Fleischeinlassöffnung ø 52 mm** - Sicherheitsmikroschalter am Trichter - Umkehrgetriebe - Getriebemotor mit Ölbad. Ausgestattet mit Enterprise System mit Edelstahlplatte (Löcher ø 6 mm) und selbstschärfendem Edelmessner.
- ES Carcasa y tolva de acero inoxidable. Grupo de picar de acero inoxidable AISI 304 extraíble - ventilador de enfriamiento - **boca de ø 52 mm para introducir la carne** - reductor con engranajes en baño de aceite. En dotación sistema enterprice con placa de acero inoxidable (agujeros ø 6 mm) y cuchilla de acero inoxidable con autoafilado".
- RU Корпус и воронка из нержавеющей стали. Съёмная режущая группа из нержавеющей стали AISI 304 - Охлаждающий вентилятор - **Мясоприемник ø 52 mm** - Привод с масляной ванной - Система Enterprise с решеткой из нержавеющей стали (отверстия ø 6 мм) и самозатачивающимся ножом из нержавеющей стали.

	<b>32RSE</b>	
	1,6 kW (2,2 HP)	
	230-400V/3N/50Hz	
	230V/1N/50Hz	
	250+350 Kg/h	
	490 x 340 x 530(h) mm	
		
	 41 Kg	 38 Kg
	 46 Kg	 43 Kg
	570 x 420 x 680(h) mm	
	0,163 m³	

# 22RG



64 mm

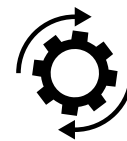

Inversione di marcia  
Function reverse  
Реверс



1,5 HP

# Tritacarne

MEAT MINCER  
HACHOIR À VIANDE  
FLEISCHWOLF  
PICADORE DE CARNE  
МЯСОРУБКА

IT Carcassa e tramoggia in acciaio inox. Gruppo macinazione estraibile in acciaio inox AISI 304 - **bocca ingresso carne ø 64 mm** - microinterruttori di sicurezza su tramoggia - **inversione di marcia** - riduttore con ingranaggi a bagno d'olio. In dotazione sistema enterprise con piastra inox (fori ø 6 mm) e coltello inox autoaffilante.

EN Stainless steel casing and hopper. Removable grinding unit in stainless steel AISI 304 - **meat inlet ø 64 mm** - safety microswitches on the hopper - **reverse function** - oiled gear motor. Equipped with enterprise system with stainless steel plate (holes ø 6 mm) and self-sharpening stainless steel knife.

FR Corps et trémie en acier inox - groupe de hachage amovible en acier inox AISI 304 - **orifice d'entrée viande ø 64 mm** - micro-interrupteurs de sécurité sur la trémie - **inversion de marche** - motoréducteur à engrenages à bain d'huile. De série ,système enterprice avec plaque en inox (trous ø 6 mm) et couteau inox aiguisement automatique.

DE Gehäuse und Trichter aus Edelstahl - herausnehmbare Schneidegruppe aus Edelstahl AISI 304 - **Fleischeinführöffnung ø 64 mm** - Sicherheitsmikroschalter am Trichter - **Umkehrgetriebe** - Getriebemotor mit Ölbad - ausgestattet mit Enterprise-System mit Edelstahlplatte (Löcher 6 mm) und selbstschärfendem Edelmessner.

ES Carcasa y tolva de acero inoxidable - grupo para picar de acero inoxidable (AISI 304) extraíble - **boca de ø 64 mm para introducir la carne** - microinterruptores de seguridad en la tolva - **inversión de marcha** - reductor con engranajes en baño de aceite. En la dotación sistema enterprise con placa de acero inoxidable (agujeros ø 6 mm) y cuchilla de acero inoxidable con autoafilado.

RU Корпус и воронка из нержавеющей стали - Съемная режущая группа из нержавеющей стали AISI 304 - **Мясоприемник ø 64 mm** - Предохранительный микровыключатель на воронке - **Реверс** - Привод с масляной ванной - Система Enterprise с решеткой из нержавеющей стали (отверстия ø 6 мм) и самозатачивающимся ножом из нержавеющей стали.

	<b>22RG</b>
	1,1 kW (1,5 HP)
	230-400V/3/50Hz
	
	230V/1N/50Hz
	200=300 Kg/h
	410 x 310 x 490(h) mm
	
	32 Kg
	38 Kg
	570 x 420 x 680(h) mm
	0,163 m³

# 22RGE *New*



64 mm



1,5 HP

# Tritacarne

MEAT MINCER  
HACHOIR À VIANDE  
FLEISCHWOLF  
PICADORE DE CARNE  
МЯСОРУБКА



- IT Carcassa e tramoggia in acciaio inox. Gruppo macinazione estraibile in acciaio inox AISI 304 - **bocca ingresso carne ø 64 mm** - microinterruttori di sicurezza su tramoggia - riduttore con ingranaggi a bagno d'olio. In dotazione sistema enterprise con piastra inox (fori ø 6 mm) e coltello inox autoaffilante.
- EN Stainless steel casing and hopper. Removable grinding unit in stainless steel AISI 304 - **meat inlet ø 64 mm** - safety microswitches on the hopper - oiled gear motor. Equipped with enterprise system with stainless steel plate (holes ø 6 mm) and self-sharpening stainless steel knife.
- FR Corps et trémie en acier inox - groupe de hachage amovible en acier inox AISI 304 - **orifice d'entrée viande ø 64 mm** - micro-interrupteurs de sécurité sur la trémie - motoréducteur à engrenages à bain d'huile. De série ,système enterprise avec plaque en inox (trous ø 6 mm) et couteau inox aiguisement automatique.
- DE Gehäuse und Trichter aus Edelstahl - herausnehmbare Schneidegruppe aus Edelstahl AISI 304 - **Fleischeinführöffnung ø 64 mm** - Sicherheitsmikroschalter am Trichter - Getriebemotor mit Ölbad - ausgestattet mit Enterprise-System mit Edelstahlplatte (Löcher 6 mm) und selbstschärfendem Edelmessler.
- ES Carcasa y tolva de acero inoxidable - grupo para picar de acero inoxidable (AISI 304) extraíble - **boca de ø 64 mm para introducir la carne** - microinterruptores de seguridad en la tolva - reductor con engranajes en baño de aceite. En la dotación sistema enterprise con placa de acero inoxidable (agujeros ø 6 mm) y cuchilla de acero inoxidable con autoafilado.
- RU Корпус и воронка из нержавеющей стали - Съёмная режущая группа из нержавеющей стали AISI 304 - **Мясоприемник ø 64 mm** - Предохранительный микровыключатель на воронке - Привод с масляной ванной - Система Enterprise с решеткой из нержавеющей стали (отверстия ø 6 мм) и самозатачивающимся ножом из нержавеющей стали.

	<b>22RGE</b>
	1,1 kW (1,5 HP)
	230-400V/3N/50Hz
	
	230V/1N/50Hz
	200=300 Kg/h
	
	410 x 310 x 490(h) mm
	
	32 Kg
	38 Kg
	570 x 420 x 680(h) mm
	0,163 m³

# 22RS



52 mm

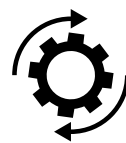

Inversione di marcia  
Function reverse  
Реверс



1,5 HP







# Tritacarne

MEAT MINCER  
HACHOIR À VIANDE  
FLEISCHWOLF  
PICADORE DE CARNE  
МЯСОРУБКА



GUARDA IL VIDEO  
WATCH THE VIDEO

- IT Carcassa e tramoggia in acciaio inox. Gruppo macinazione estraibile in acciaio inox AISI 304 - **bocca ingresso carne ø 52 mm - inversione di marcia** - riduttore con ingranaggi a bagno d'olio. In dotazione sistema enterprise con piastra inox (fori ø 6 mm) e coltello inox autoaffilante.
- EN Stainless steel casing and hopper. Removable grinding unit in stainless steel AISI 304 - **meat inlet ø 52 mm - reverse function** - oiled gear motor. Equipped with enterprise system with stainless steel plate (holes ø 6 mm) and self-sharpening stainless steel knife.
- FR Corps et trémie en acier inox - groupe de hachage amovible en acier inox AISI 304 - **orifice d'entrée viande ø 52 mm - inversion de marche** - motoréducteur à engrenages à bain d'huile. De série ,système enterprise avec plaque en inox (trous ø 6 mm) et couteau inox aiguisement automatique.
- DE Gehäuse und Trichter aus Edelstahl - herausnehmbare Schneidegruppe aus Edelstahl AISI 304 - **Fleischeinführöffnung ø 52 mm - Umkehrgetriebe** - Getriebemotor mit Ölbad - ausgestattet mit Enterprise-System mit Edelstahlplatte (Löcher 6 mm) und selbstschärfendem Edelstahlmesser.
- ES Carcasa y tolva de acero inoxidable - grupo para picar de acero inoxidable (AISI 304) extraíble - **boca de ø 52 mm para introducir la carne - inversión de marcha** - reductor con engranajes en baño de aceite. En la dotación sistema enterprise con placa de acero inoxidable (agujeros ø 6 mm) y cuchilla de acero inoxidable con autoafilado.
- RU Корпус и воронка из нержавеющей стали - Съемная режущая группа из нержавеющей стали AISI 304 - **Мясоприемник ø 52 мм - Реверс** - Привод с масляной ванной - Система Enterprise с решеткой из нержавеющей стали (отверстия ø 6 мм) и самозатачивающимся ножом из нержавеющей стали.

	<b>22RS</b>
	1,1 kW (1,5 HP)
	230-400V/3/50Hz
	230V/1N/50Hz
	150÷250 Kg/h
	410 x 310 x 520(h) mm
	
	32 Kg
	38 Kg
	570 x 420 x 680(h) mm
	0,163 m³

# 22RSE

New



52 mm



1,5 HP

# Tritacarne

MEAT MINCER  
HACHOIR À VIANDE  
FLEISCHWOLF  
PICADORE DE CARNE  
МЯСОРУБКА

- IT Carcassa e tramoggia in acciaio inox. Gruppo macinazione estraibile in acciaio inox AISI 304 - **bocca ingresso carne ø 52 mm** - riduttore con ingranaggi a bagno d'olio. In dotazione sistema enterprise con piastra inox (fori ø 6 mm) e coltello inox autoaffilante.
- EN Stainless steel casing and hopper. Removable grinding unit in stainless steel AISI 304 - **meat inlet ø 52 mm** - oiled gear motor. Equipped with enterprise system with stainless steel plate (holes ø 6 mm) and self-sharpening stainless steel knife.
- FR Corps et trémie en acier inox - groupe de hachage amovible en acier inox AISI 304 - **orifice d'entrée viande ø 52** - motoréducteur à engrenages à bain d'huile. De série, système enterprise avec plaque en inox (trous ø 6 mm) et couteau inox à aiguisement automatique.
- DE Gehäuse und Trichter aus Edelstahl - herausnehmbare Schneidegruppe aus Edelstahl AISI 304 - **Fleischeinführöffnung ø 52 mm** - Getriebemotor mit Ölbad - ausgestattet mit Enterprise-System mit Edelstahlplatte (Löcher 6 mm) und selbstschärfendem Edelmesserschneider.
- ES Carcasa y tolva de acero inoxidable - grupo para picar de acero inoxidable (AISI 304) extraíble - **boca de ø 52 mm para introducir la carne** - reductor con engranajes en baño de aceite. En la dotación sistema enterprise con placa de acero inoxidable (agujeros ø 6 mm) y cuchilla de acero inoxidable con autoafilado.
- RU Корпус и воронка из нержавеющей стали - Съёмная режущая группа из нержавеющей стали AISI 304 - **Мясоприемник ø 52 мм** - Привод с масляной ванной - Низковольтное управление - Система Enterprise с решеткой из нержавеющей стали (отверстия ø 6 мм) и самозатачивающимся ножом из нержавеющей стали.

	<b>22RSE</b>
	1,1 kW (1,5 HP)
 3 Ph	230-400V/3N/50Hz
 1 Ph	230V/1N/50Hz
 Kg/h	150÷250 Kg/h
 mm	410 x 310 x 520(h) mm
	
 NET Kg	32 Kg
 GROSS Kg	38 Kg
 mm	570 x 420 x 680(h) mm
 m <sup>3</sup>	0,163 m <sup>3</sup>

# 22TS



52 mm

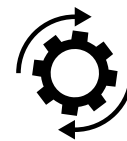

Inversione di marcia  
Function reverse  
Реверс



1,5 HP



## Tritacarne

MEAT MINCER  
HACHOIR À VIANDE  
FLEISCHWOLF  
PICADORE DE CARNE  
МЯСОРУБКА

IT Carcassa e tramoggia in acciaio inox. Macchina con gruppo di macinazione completamente removibile, che permette di poterlo collocare in frigorifero - il gruppo di macinazione in acciaio inox AISI 304 può essere lavato in lavastoviglie - **bocca ingresso carne ø 52 mm** - **inversione di marcia** - riduttore con ingranaggi a bagno d'olio. In dotazione sistema enterprise con piastra inox (fori ø 6 mm) e coltello inox autoaffilante.

EN Stainless steel casing and hopper. Machine with a completely removable grinding unit that allows it to be placed in the refrigerator - the grinding unit in stainless steel AISI 304 can be washed in the dishwasher - **meat inlet ø 52 mm** - **reverse function** - oiled gear motor. Equipped with enterprise system with stainless steel plate (holes ø 6 mm) and self-sharpening stainless steel knife.

FR Corps et trémie en acier inox. Machine avec groupe de hachage entièrement amovible qui permet de pouvoir le placer dans le réfrigérateur sans avoir à nettoyer les résidus de viande hachée après chaque utilisation conformément - l'unité de hachage en acier inox AISI 304 peut être lavée au lave-vaisselle - **orifice d'entrée viande ø 52 mm** - **inversion de marche** - motoréducteur à engrenages à bain d'huile. De série, système enterprise avec plaque en inox (trous ø 6 mm) et couteau inox aiguisement automatique.

DE Gehäuse und Trichter aus Edelstahl - Maschine mit Zerkleinerungseinheit, die vollständig abnehmbar ist und daher die Aufbewahrung im Kühlschrank gestattet ohne vorher nach jeder Verwendung in Übereinstimmung mit den HACCP Hygienevorschriften von den Hackfleischrückständen gereinigt zu werden, die Zerkleinerungseinheit aus Edelstahl AISI 304 kann in der Geschirrspülmaschine gereinigt werden. **Fleischeinlassöffnung ø 52 mm** - **Umkehrgetriebe** - Getriebemotor mit Ölbad - ausgestattet mit Enterprise-System mit Edelstahlplatte (Löcher ø 6 mm) und selbstschärfendem Edelstahlmesser.

ES Carcasa y tolva de acero inoxidable - Máquina con grupo de picar completamente extraíble que permite poderlo colocar en la nevera sin que tenga que ser limpiado de los restos de carne picada después de cada utilización - el grupo de picar de acero inoxidable AISI 304 puede ser limpiado en el lavavajillas - **boca de ø 52 mm para introducir la carne** - **inversión de marcha** - reductor con engranajes en baño de aceite. En la dotación sistema enterprise con placa de acero inoxidable (agujeros ø 6 mm) y cuchilla de acero inoxidable con autoafilado.

RU Корпус и воронка из нержавеющей стали - Машина с полностью съемным измельчающим устройством, которое может храниться в холодильнике без предварительной очистки от мясного фарша после каждого использования в соответствии с гигиеническими нормами HACCP, узел измельчения из нержавеющей стали AISI 304 можно мыть в посудомоечной машине. **Мясоприемник ø 52 мм** - **Реверс** - Привод с масляной ванной - Низковольтное управление - Система Enterprise с решеткой из нержавеющей стали (отверстия ø 6 мм) и самозатачивающимся ножом из нержавеющей стали.

	<b>22TS</b>
	1,1 kW (1,5 HP)
	230-400V/3/50Hz
	230V/1N/50Hz
	150÷250 Kg/h
	420 x 300 x 520(h) mm
	
	31 Kg
	40 Kg
	570 x 420 x 680(h) mm
	0,163 m³

# 22TSE

New



52 mm



1,5 HP



## Tritacarne

MEAT MINCER  
HACHOIR À VIANDE  
FLEISCHWOLF  
PICADORE DE CARNE  
МЯСОРУБКА



IT Carcassa e tramoggia in acciaio inox. Macchina con gruppo di macinazione completamente removibile, che permette di poterlo collocare in frigorifero - il gruppo di macinazione in acciaio inox AISI 304 può essere lavato in lavastoviglie - **bocca ingresso carne ø 52 mm** - riduttore con ingranaggi a bagno d'olio. In dotazione sistema enterprise con piastra inox (fori ø 6 mm) e coltello inox autoaffilante.

EN Stainless steel casing and hopper. Machine with a completely removable grinding unit that allows it to be placed in the refrigerator - hygiene standards - the grinding unit in stainless steel AISI 304 can be washed in the dishwasher - **meat inlet ø 52 mm** - oiled gear motor. Equipped with enterprise system with stainless steel plate (holes ø 6 mm) and self-sharpening stainless steel knife.

FR Corps et trémie en acier inox. Machine avec groupe de hachage entièrement amovible qui permet de pouvoir le placer dans le réfrigérateur - l'unité de hachage en acier inox AISI 304 peut être lavée au lave-vaisselle - **orifice d'entrée viande ø 52 mm** - motoréducteur à engrenages à bain d'huile. De série, système enterprise avec plaque en inox (trous ø 6 mm) et couteau inox aiguisement automatique.

DE Gehäuse und Trichter aus Edelstahl. Maschine mit Zerkleinerungseinheit, die vollständig abnehmbar ist und daher die Aufbewahrung im Kühlschrank gestattet - Hygienevorschriften von den Hackfleischrückständen gereinigt zu werden, die Zerkleinerungseinheit aus Edelstahl AISI 304 kann in der Geschirrspülmaschine gereinigt werden. **Fleischeinlassöffnung ø 52 mm** - Getriebemotor mit Ölbad - ausgestattet mit Enterprise-System mit Edelstahlplatte (Löcher ø 6 mm) und selbstschärfendem Edelmessers.

ES Carcasa y tolva de acero inoxidable. Máquina con grupo de picar completamente extraíble que permite poderlo colocar en la nevera. El grupo de picar de acero inoxidable AISI 304 puede ser limpiado en el lavavajillas - **boca de ø 52 mm para introducir la carne** - reductor con engranajes en baño de aceite. En la dotación sistema enterprise con placa de acero inoxidable (agujeros ø 6 mm) y cuchilla de acero inoxidable con autoafilado.

RU Корпус и воронка из нержавеющей стали. Машина с полностью съемным измельчающим устройством, которое может храниться в холодильнике, узел измельчения из нержавеющей стали AISI 304 можно мыть в посудомоечной машине. Низковольтное управление - **Мясоприемник ø 52 мм** - Привод с масляной ванной - Система Enterprise с решеткой из нержавеющей стали (отверстия ø 6 мм) и самозатачивающимся ножом из нержавеющей стали.

	<b>22TSE</b>
	1,1 kW (1,5 HP)
	230-400V/3N/50Hz
	
	230V/1N/50Hz
	150÷250 Kg/h
	420 x 300 x 520(h) mm
	
	31 Kg
	40 Kg
	570 x 420 x 680(h) mm
	0,163 m³

# 22SN



52 mm



1,5 HP

# Tritacarne

MEAT MINCER  
HACHOIR À VIANDE  
FLEISCHWOLF  
PICADORE DE CARNE  
МЯСОРУБКА

IT Struttura in alluminio lucidato con tramoggia in acciaio inox. Gruppo macinazione estraibile in acciaio inox AISI 304 - **bocca ingresso carne ø 52 mm** - riduttore con ingranaggi a bagno d'olio. In dotazione sistema enterprise con piastra inox (fori ø 6 mm) e coltello inox autoaffilante.

EN Polished aluminium structure with stainless steel hopper - removable grinding unit in stainless steel AISI 304 - **meat inlet ø 52 mm** - oiled gear motor. Equipped with enterprise system with stainless steel plate (holes ø 6 mm) and self-sharpening stainless steel knife.

FR Corps en aluminium poli avec trémie en acier inox. Groupe de hachage amovible en acier inox AISI 304 - **orifice d'entrée viande ø 52 mm** - motoréducteur à engrenages à bain d'huile. De série, système enterprise avec plaque en inox (trous ø 6 mm) et couteau inox aiguisement automatique.

DE Poliertes Aluminiumgehäuse mit Edelstahltrichter. Ausziehbare Zerkleinerungseinheit aus Edelstahl AISI 304 - **Fleischeinführöffnung ø 52 mm** - Getriebemotor mit Ölbad - ausgestattet mit Enterprise-System mit Edelstahlplatte (Löcher ø 6 mm) und selbstschärfendem Edelmessers.

ES Estructura de aluminio pulido con tolva de acero inoxidable. Grupo para picar de acero inoxidable (AISI 304) extraíble - **boca de ø 52 mm para introducir la carne** - reductor con engranajes en baño de aceite. En la dotación sistema enterprise con placa de acero inoxidable (agujeros ø 6 mm) y cuchilla de acero inoxidable con autoafilado.

RU Корпус из полированного алюминия с воронкой из нержавеющей стали. Съёмная режущая группа из нержавеющей стали AISI 304 - **Мясоприемник ø 52 мм** - Привод с масляной ванной - Система Enterprise с решеткой из нержавеющей стали (отверстия ø 6 мм) и самозатачивающимся ножом из нержавеющей стали.

	<b>22SN</b>
	1,1 kW (1,5 HP)
 3 Ph	230-400V/3/50Hz
 1 Ph	230V/1N/50Hz
 Kg/h	150÷250 Kg/h
 mm	450 x 290 x 520(h) mm
	
 NET Kg	23 Kg
 GROSS Kg	25 Kg
 mm	540 x 300 x 480(h) mm
 m <sup>3</sup>	0,078 m <sup>3</sup>

# 22TE



52 mm



1,5 HP



## Tritacarne

MEAT MINCER  
HACHOIR À VIANDE  
FLEISCHWOLF  
PICADORE DE CARNE  
МЯСОРУБКА

IT Struttura in alluminio lucidato con tramoggia in acciaio inox. Macchina con gruppo di macinazione completamente removibile che permette di poterlo collocare in frigorifero - il gruppo di macinazione in acciaio inox AISI 304 può essere lavato in lavastoviglie - **bocca ingresso carne ø 52 mm** - riduttore con ingranaggi a bagno d'olio - in dotazione sistema enterprise con piastra inox (fori ø 6 mm) e coltello inox autoaffilante.

EN Polished aluminium structure with stainless steel hopper - Machine with a completely removable grinding unit that allows it to be placed in the refrigerator - the grinding unit in stainless steel AISI 304 can be washed in the dishwasher - **meat inlet ø 52 mm** - oiled gear motor. Equipped with enterprise system with stainless steel plate (holes ø 6 mm) and self-sharpening stainless steel knife.

FR Corps en aluminium poli avec trémie en acier inox. Machine avec groupe de hachage entièrement amovible qui permet de pouvoir le placer dans le réfrigérateur - l'unité de hachage en acier inox AISI 304 peut être lavée au lave-vaisselle - **orifice d'entrée viande ø 52 mm** - motoréducteur à engrenages à bain d'huile. De série, système enterprise avec plaque en inox (trous ø 6 mm) et couteau inox aiguisement automatique.

DE Gehäuse aus poliertem Aluminium mit Trichter aus Edelstahl. Maschine mit Zerkleinerungseinheit, die vollständig abnehmbar ist und daher die Aufbewahrung im Kühlschrank gestattet - Hygienevorschriften von den Hackfleischrückständen gereinigt zu werden, die Zerkleinerungseinheit aus Edelstahl AISI 304 kann in der Geschirrspülmaschine gereinigt werden. **Fleischeinlassöffnung ø 52 mm** - Getriebemotor mit Ölbad - ausgestattet mit Enterprise-System mit Edelstahlplatte (Löcher ø 6 mm) und selbstschärfendem Edelmessers.

ES Estructura de aluminio pulido con tolva de acero inoxidable. Máquina con grupo de picar completamente extraíble que permite poderlo colocar en la nevera. El grupo de picar de acero inoxidable AISI 304 puede ser limpiado en el lavavajillas - **boca de ø 52 mm para introducir la carne** - reductor con engranajes en baño de aceite - en la dotación sistema enterprise con placa de acero inoxidable (agujeros ø 6 mm) y cuchilla de acero inoxidable con autoafilado.

RU Корпус из полированного алюминия с воронкой из нержавеющей стали. Машина с полностью съемным измельчающим устройством, которое может храниться в холодильнике без предварительной очистки от мясного фарша после каждого использования в соответствии с гигиеническими нормами HACCP, узел измельчения из нержавеющей стали AISI 304 можно мыть в посудомоечной машине. **Мясоприемник ø 52 мм** - Привод с масляной ванной - Система Enterprise с решеткой из нержавеющей стали (отверстия ø 6 мм) и самозатачивающимся ножом из нержавеющей стали.

	<b>22TE</b>
	1,1 kW (1,5 HP)
	230-400V/3N/50Hz
	230V/1N/50Hz
	150÷250 Kg/h
	450 x 290 x 520(h) mm
	
	25 Kg
	27 Kg
	540 x 300 x 480(h) mm
	0,078 m³

# 22CE

New



52 mm



1,5 HP



# Tritacarne

MEAT MINCER  
HACHOIR À VIANDE  
FLEISCHWOLF  
PICADORE DE CARNE  
МЯСОРУБКА

IT Carcassa e tramoggia in acciaio inox. Macchina con gruppo di macinazione completamente removibile, che permette di poterlo collocare in frigorifero - il gruppo di macinazione in acciaio inox AISI 304 può essere lavato in lavastoviglie - **bocca ingresso carne ø 52 mm** - riduttore con ingranaggi a bagno d'olio. In dotazione sistema enterprise con piastra inox (fori ø 6 mm) e coltello inox autoaffilante.

EN Stainless steel casing and hopper. Machine with a completely removable grinding unit that allows it to be placed in the refrigerator - hygiene standards - the grinding unit in stainless steel AISI 304 can be washed in the dishwasher - **meat inlet ø 52 mm** - oiled gear motor. Equipped with enterprise system with stainless steel plate (holes ø 6 mm) and self-sharpening stainless steel knife.

FR Corps et trémie en acier inox - Machine avec groupe de hachage entièrement amovible qui permet de pouvoir le placer dans le réfrigérateur. L'unité de broyage en acier inox AISI 304 peut être lavée au lave-vaisselle - **orifice d'entrée viande ø 52 mm** - motoréducteur à engrenages à bain d'huile. De série, système enterprise avec plaque en inox (trous ø 6 mm) et couteau inox aiguisement automatique.

DE Gehäuse und Trichter aus Edelstahl - Maschine mit Zerkleinerungseinheit, die vollständig abnehmbar ist und daher die Aufbewahrung im Kühlschrank gestattet - Hygienevorschriften von den Hackfleischrückständen gereinigt zu werden, die Zerkleinerungseinheit aus Edelstahl AISI 304 kann in der Geschirrspülmaschine gereinigt werden. **Fleischeinlassöffnung ø 52 mm** - a usgestattet mit Enterprise-System mit Edelstahlplatte (Löcher ø 6 mm) und selbstschärfendem Edelmessers.

ES Carcasay tolva de acero inoxidable - Máquina con grupo de picar completamente extraíble que permite poderlo colocar en la nevera. El grupo de picar de acero inoxidable AISI 304 puede ser limpiado en el lavavajillas - **boca de ø 52 mm para introducir la carne** - reductor con engranajes en baño de aceite. En la dotación sistema enterprise con placa de acero inoxidable (agujeros ø 6 mm) y cuchilla de acero inoxidable con autoafilado.

RU Корпус и воронка из нержавеющей стали - Машина с полностью съемным измельчающим устройством, которое может храниться в холодильнике без предварительной очистки от мясного фарша после каждого использования в соответствии с гигиеническими нормами HACCP, узел измельчения из нержавеющей стали AISI 304 можно мыть в посудомоечной машине. Низковольтное управление - **Мясоприемник ø 52 мм** - Система Enterprise с решеткой из нержавеющей стали (отверстия ø 6 мм) и самозатачивающимся ножом из нержавеющей стали.

	<b>22CE</b>
	1,1 kW (1,5 HP)
	230-400V/3N/50Hz
	230V/1N/50Hz
	150÷250 Kg/h
	470 x 270 x 450(h) mm
	
	
	26 Kg
	28 Kg
	540 x 300 x 480(h) mm
	0,078 m³

# 12TS



52 mm



1 HP



# Tritacarne

MEAT MINCER  
HACHOIR À VIANDE  
FLEISCHWOLF  
PICADORE DE CARNE  
МЯСОРУБКА



IT Struttura in alluminio lucidato con tramoggia in acciaio inox. Macchina con gruppo di macinazione completamente removibile che permette di poterlo collocare in frigorifero - il gruppo di macinazione in acciaio inox AISI 304 può essere lavato in lavastoviglie - **bocca ingresso carne ø 52 mm** - riduttore con ingranaggi a bagno d'olio - in dotazione sistema enterprise con piastra inox (fori ø 6 mm) e coltello inox autoaffilante.











EN Polished aluminium structure with stainless steel hopper - Machine with a completely removable grinding unit that allows it to be placed in the refrigerator - the grinding unit in stainless steel AISI 304 can be washed in the dishwasher - **meat inlet ø 52 mm** - oiled gear motor. Equipped with enterprise system with stainless steel plate (holes ø 6 mm) and self-sharpening stainless steel knife.

FR Corps en aluminium poli avec trémie en acier inox. Machine avec groupe de hachage entièrement amovible qui permet de pouvoir le placer dans le réfrigérateur - l'unité de hachage en acier inox AISI 304 peut être lavée au lave-vaisselle - **orifice d'entrée viande ø 52 mm** - motoréducteur à engrenages à bain d'huile. De série, système enterprise avec plaque en inox (trous ø 6 mm) et couteau inox aguisement automatique.

DE Gehäuse aus poliertem Aluminium mit Trichter aus Edelstahl. Maschine mit Zerkleinerungseinheit, die vollständig abnehmbar ist und daher die Aufbewahrung im Kühlschrank gestattet - Hygienevorschriften von den Hackfleischrückständen gereinigt zu werden, die Zerkleinerungseinheit aus Edelstahl AISI 304 kann in der Geschirrspülmaschine gereinigt werden. **Fleischeinlassöffnung ø 52 mm** - Getriebemotor mit Ölbad - ausgestattet mit Enterprise-System mit Edelstahlplatte (Löcher ø 6 mm) und selbstschärfendem Edelmessers.

ES Carcasa de aluminio pulido con tolva de acero inoxidable. Máquina con grupo de picar completamente extraíble que permite poderlo colocar en la nevera. El grupo de picar de acero inoxidable AISI 304 puede ser limpiado en el lavavajillas - **boca para introducir la carne ø 52 mm** - reductor con engranajes en baño de aceite - en dotación sistema enterprise con placa de acero inoxidable (agujeros ø 6 mm) y cuchilla de acero inoxidable con autoafilado.

RU Корпус из полированного алюминия с воронкой из нержавеющей стали. Машина с полностью съемным измельчающим устройством, которое может храниться в холодильнике без предварительной очистки от мясного фарша после каждого использования в соответствии с гигиеническими нормами HACCP, узел измельчения из нержавеющей стали AISI 304 можно мыть в посудомоечной машине. **Мясоприемник ø 52 мм** - Привод с масляной ванной - Система Enterprise с решеткой из нержавеющей стали (отверстия ø 6 мм) и самозатачивающимся ножом из нержавеющей стали.

	<b>12TS</b>
	0,75 kW (1 HP)
	230-400V/3/50Hz
	230V/1N/50Hz
	100÷160 Kg/h
	400 x 290 x 510(h) mm
	
	20 Kg
	22 Kg
	540 x 300 x 480(h) mm
	0,078 m <sup>3</sup>

# 12CE

New



52 mm



1 HP



# Tritacarne

MEAT MINCER  
HACHOIR À VIANDE  
FLEISCHWOLF  
PICADORE DE CARNE  
МЯСОРУБКА

IT Struttura e tramoggia in acciaio inox - Macchina con gruppo di macinazione completamente removibile che permette di poterlo collocare in frigorifero - il gruppo di macinazione in acciaio inox AISI 304 può essere lavato in lavastoviglie - **bocca ingresso carne ø 52 mm** - riduttore con ingranaggi a bagno d'olio - in dotazione sistema enterprise con piastra inox (fori ø 6 mm) e coltello inox autoaffilante.

EN Stainless steel casing and hopper. Machine with a completely removable grinding unit that allows it to be placed in the refrigerator- the grinding unit in stainless steel AISI 304 can be washed in the dishwasher - **meat inlet ø 52 mm** - oiled gear motor. Equipped with enterprise system with stainless steel plate (holes ø 6 mm) and self-sharpening stainless steel knife.

FR Corps et trémie en acier inox - Machine avec groupe de hachage entièrement amovible qui permet de pouvoir le placer dans le réfrigérateur s. En alternative, lavé également soigneusement dans un lave-vaisselle (seulement la version en acier inox). **Bouche de hachage ø 52 mm** - motoréducteur à engrenages à bain d'huile. De série, système enterprise avec plaque en inox (trous ø 6 mm) et couteau inox aiguisement automatique.

DE Gehäuse und Trichter aus Edelstahl - Maschine mit Zerkleinerungseinheit, die vollständig abnehmbar ist und daher die Aufbewahrung im Kühlschrank gestattet - Hygienevorschriften von den Hackfleischrückständen gereinigt zu werden, die Zerkleinerungseinheit aus Edelstahl AISI 304 kann in der Geschirrspülmaschine gereinigt werden. **Fleischeinlassöffnung ø 52 mm** - Umkehrgetriebe - Getriebemotor mit Ölbad - ausgestattet mit Enterprise-System mit Edelstahlplatte (Löcher ø 6 mm) und selbstschärfendem Edelstahlmesser.

ES Carcasa de aluminio pulido con tolva de acero inoxidable. Máquina con grupo de picar completamente extraíble que permite poderlo colocar en la nevera. El grupo de picar de acero inoxidable AISI 304 puede ser limpiado en el lavavajillas - **boca para introducir la carne ø 52 mm** - reductor con engranajes en baño de aceite - en dotación sistema enterprise con placa de acero inoxidable (agujeros ø 6 mm) y cuchilla de acero inoxidable con autoafilado.

RU Корпус и воронка из нержавеющей стали - Машина с полностью съемным измельчающим устройством, которое может храниться в холодильнике без предварительной очистки от мясного фарша после каждого использования в соответствии с гигиеническими нормами HACCP, узел измельчения из нержавеющей стали AISI 304 можно мыть в посудомоечной машине. **Мясоприемник ø52мм** - Реверс-Привод с масляной ванной - Система Enterprise с решеткой из нержавеющей стали (отверстия ø 6 мм) и самозатачивающимся ножом из нержавеющей стали.

	<b>12CE</b>
	0,75 kW (1 HP)
	230-400V/3N/50Hz
	
	230V/1N/50Hz
	100÷160 Kg/h
	440 x 270 x 450(h) mm
	
	22 Kg
	24 Kg
	540 x 300 x 480(h) mm
	0,078 m³

# 12S



52 mm









1 HP

# Tritacarne

MEAT MINCER  
HACHOIR À VIANDE  
FLEISCHWOLF  
PICADORE DE CARNE  
МЯСОРУБКА

- IT Struttura in alluminio lucidato con tramoggia in acciaio inox. Gruppo macinazione estraibile in acciaio inox AISI 304 - **bocca ingresso carne ø 52 mm** - riduttore con ingranaggi a bagno d'olio - in dotazione sistema enterprise con piastra inox (fori ø 6 mm) e coltello inox autoaffilante.
- EN Polished aluminium structure with stainless steel hopper - removable grinding unit in stainless steel AISI 304 - **meat inlet ø 52 mm** - oiled gear motor. Equipped with enterprise system with stainless steel plate (holes ø 6 mm) and self-sharpening stainless steel knife.
- FR Corps en aluminium poli avec trémie en acier inox. Groupe de hachage amovible en acier inox AISI 304 - **orifice d'entrée viande ø 52 mm** - motoréducteur à engrenages à bain d'huile. De série, système enterprise avec plaque en inox (trous ø 6 mm) et couteau inox aiguisement automatique.
- DE Poliertes Aluminiumgehäuse mit Edelstahltrichter. Ausziehbare Zerkleinerungseinheit aus Edelstahl AISI 304 - **Fleischeinführöffnung ø 52 mm** - Getriebemotor mit Ölbad - ausgestattet mit Enterprise-System mit Edelstahlplatte (Löcher ø 6 mm) und selbstschärfendem Edelmessner.
- ES Estructura de aluminio pulido con tolva de acero inoxidable. Grupo de picar extraíble de acero inoxidable AISI 304 - **boca de ø 52 mm para introducir la carne** - reductor con engranajes en baño de aceite - en la dotación sistema enterprise con placa de acero inoxidable (agujeros ø 6 mm) y cuchilla de acero inoxidable con autoafilado.
- RU Корпус из полированного алюминия с воронкой из нержавеющей стали. Съемная режущая группа из нержавеющей стали AISI 304 - **Мясоприемник ø 52 мм** - Привод с масляной ванной - Система Enterprise с решеткой из нержавеющей стали (отверстия ø 6 мм) и самозатачивающимся ножом из нержавеющей стали.

	<b>12S</b>
	0,75 kW (1 HP)
	230-400V/3/50Hz
	230V/1N/50Hz
	100÷160 Kg/h
	400 x 250 x 500(h) mm
	
	21 Kg
	23 Kg
	540 x 300 x 480(h) mm
	0,078 m³



# 12B



52 mm













1 HP

## Tritacarne

MEAT MINCER  
HACHOIR À VIANDE  
FLEISCHWOLF  
PICADORE DE CARNE  
МЯСОРУБКА

- IT Struttura in alluminio lucidato con tramoggia in acciaio inox. **Bocca ingresso carne ø 52 mm** - riduttore con ingranaggi a bagno d'olio - in dotazione sistema enterprise con piastra inox (fori ø 6 mm) e coltello inox autoaffilante.
- EN Polished aluminium casing and stainless steel hopper. **Meat inlet ø 52 mm** - oiled gear motor - equipped with enterprise system with stainless steel plate (holes ø 6 mm) and self-sharpening stainless steel knife.
- FR Corps en aluminium poli et trémie en acier inox. **Orifice d'entrée viande ø 52 mm**. Motoréducteur à engrenages à bain d'huile - de série, système enterprise avec plaque en inox (trous ø 6 mm) et couteau inox à aiguisement automatique.
- DE Gehäuse aus poliertem Aluminium mit Trichter aus Edelstahl - **Fleischieinführöffnung ø 52 mm** - Getriebemotor mit Ölbad - ausgestattet mit Enterprise-System mit Edelstahlplatte (Löcher ø 6 mm) und selbstschärfendem Edelmessers.
- ES Estructura de aluminio pulido con tolva de acero inoxidable. **Boca para introducir la carne ø 52 mm** - en la dotación sistema enterprise con placa de acero inoxidable (agujeros ø 6 mm) y cuchilla de acero inoxidable con autoafilado.
- RU Корпус из полированного алюминия с воронкой из нержавеющей стали. **Мясоприемник ø 52 мм** - Привод с масляной ванной - Система Enterprise с решеткой из нержавеющей стали (отверстия ø 6 мм) и самозатачивающимся ножом из нержавеющей стали.

	<b>12B</b>
	0,75 kW (1 HP)
 1 Ph	230V/1N/50Hz
 Kg/h	100÷160 Kg/h
 mm	400 x 250 x 500(h) mm
	
 Kg	21 Kg
 Kg	23 Kg
 mm	540 x 300 x 480(h) mm
 m <sup>3</sup>	0,078 m <sup>3</sup>

# 22AT



52 mm

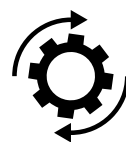

Inversione di marcia  
Function reverse  
Реверс



1,5 HP



## Abbinato Tritacarne e Grattugia

COMBINED MEAT MINCER AND GRATER  
HACHOIR À VIANDE ET RÂPE COMBINÉS  
PICADORA DE CARNE Y RALLADOR COMBINADOS  
KOMBINIERTER FLEISCHWOLF UND REIBE  
ДВОЙНАЯ ФУНКЦИЯ МЯСОРУБКИ И ТЕРКИ



IT Carcassa e tramoggia in acciaio inox. Macchina con gruppo di macinazione completamente removibile, che permette di poterlo collocare in frigorifero - il gruppo di macinazione in acciaio inox AISI 304 può essere lavato in lavastoviglie - **bocca ingresso carne ø 52 mm - inversione di marcia** - riduttore con ingranaggi a bagno d'olio. In dotazione sistema enterprise con piastra inox (fori ø 6 mm) e coltello inox autoaffilante. La parte della grattugia è caratterizzata da: bocca in alluminio lucidato 140x75 mm - rullo in acciaio inox - griglia inferiore di protezione - microinterruttore leva pressore grattugia.









EN Stainless steel casing and hopper. Machine with a completely removable grinding unit that allows it to be placed in the refrigerator - the grinding unit in stainless steel AISI 304 can be washed in the dishwasher - **meat inlet ø 52 mm - reverse function** - oiled gear motor. Equipped with enterprise system with stainless steel plate (holes ø 6 mm) and self-sharpening stainless steel knife. Grater section featured by: polished aluminium inlet 140x75 mm - stainless steel roller - lower protection grid - microswitch on the grater pusher.

FR Corps en aluminium poli avec trémie en acier inox. Machine avec groupe de hachage entièrement amovible qui permet de pouvoir le placer dans le réfrigérateur - l'unité de hachage en acier inox AISI 304 peut être lavée au lave-vaisselle - **orifice d'entrée viande ø 52 mm - inversion de marche** - motoréducteur à engrenages à bain d'huile. De série, système enterprise avec plaque en inox (trous ø 6 mm) et couteau inox aiguisement automatique. La partie de la râpe se caractérise par: orifice d'entrée en aluminium poli 140x75 mm - rouleau en acier inox - grille de protection inférieure - microrupteur à levier sur le bras pousseur.

DE Gehäuse aus poliertem Aluminium mit Trichter aus Edelstahl. Maschine mit Zerkleinerungseinheit, die vollständig abnehmbar ist und daher die Aufbewahrung im Kühlschrank gestattet ohne vorher nach jeder Verwendung in Übereinstimmung mit den HACCP Hygienevorschriften von den Hackfleischrückständen gereinigt zu werden, die Zerkleinerungseinheit aus Edelstahl AISI 304 kann in der Geschirrspülmaschine gereinigt werden. **Fleischeinlassöffnung ø 52 mm - Umkehrgetriebe** - Getriebemotor mit Ölbad - ausgestattet mit Enterprise-System mit Edelstahlplatte (Löcher ø 6 mm) und selbstschärfendem Edelstahlmesser. Teile der Reibe: Einführöffnung aus poliertem Aluminium 140x75 mm - Rolle aus Edelstahl - unterer Schutzrost - Mikroschalter am Einfüllhebel der Reibe.

ES Carcasa de aluminio pulido con tolva de acero inoxidable. Máquina con grupo de picar completamente extraíble que permite poderlo colocar en la nevera - El grupo de picar de acero inoxidable AISI 304 puede ser limpiado en el lavavajillas - **boca para introducir la carne ø 52 mm - inversión de marcha** - reductor con engranajes en baño de aceite - en dotación sistema enterprise con placa de acero inoxidable (agujeros ø 6 mm) y cuchilla de acero inoxidable con autoafilado. La parte del rallador se caracteriza por: boca de aluminio pulido 140x75 mm - rodillo de acero inoxidable - rejilla inferior de protección - empujador con microinterruptor.

RU Корпус из полированного алюминия с воронкой из нержавеющей стали. Машина с полностью съемным измельчающим устройством, которое может храниться в холодильнике без предварительной очистки от мясного фарша после каждого использования в соответствии с гигиеническими нормами HACCP, узел измельчения из нержавеющей стали AISI 304 можно мыть в посудомоечной машине. Низковольтное управление - **Мясоприемник ø 52 мм - Реверс** - Привод с масляной ванной - Система Enterprise с решеткой из нержавеющей стали (отверстия ø 6 мм) и самозатачивающимся ножом из нержавеющей стали. Детали терки: приемный лоток из полированного алюминия 140x75 мм - цилиндр из нержавеющей стали - нижняя защитная решетка - микровыключатель на прижимном рычаге терки.

	<b>22AT</b>	
	1,1 kW (1,5 HP)	
	230-400V/3/50Hz	
	230V/1N/50Hz	
	 150÷250 Kg/h	 40 Kg/h
	560 x 430 x 480÷650(h) mm	
		
	38 Kg	
	48 Kg	
	770 x 520 x 580(h) mm	
	0,232 m³	

# 22ATE

New



52 mm



1,5 HP



## Abbinato Tritacarne e Grattugia

COMBINED MEAT MINCER AND GRATER  
HACHOIR À VIANDE ET RÂPE COMBINÉS  
PICADORA DE CARNE Y RALLADOR COMBINADOS  
KOMBINIERTER FLEISCHWOLF UND REIBE  
ДВОЙНАЯ ФУНКЦИЯ МЯСОРУБКИ И ТЕРКИ

IT Carcassa e tramoggia in acciaio inox. Macchina con gruppo di macinazione completamente removibile, che permette di poterlo collocare in frigorifero - il gruppo di macinazione in acciaio inox AISI 304 può essere lavato in lavastoviglie - **bocca ingresso carne ø 52 mm** - riduttore con ingranaggi a bagno d'olio. In dotazione sistema enterprise con piastra inox (fori ø 6 mm) e coltello inox autoaffilante. La parte della grattugia è caratterizzata da: bocca in alluminio lucidato 140x75 mm - rullo in acciaio inox - griglia inferiore di protezione - microinterruttore leva pressione grattugia.















EN Stainless steel casing and hopper. Machine with a completely removable grinding unit that allows it to be placed in the refrigerator - the grinding unit in stainless steel AISI 304 can be washed in the dishwasher - **meat inlet ø 52 mm** - oiled gear motor. Equipped with enterprise system with stainless steel plate (holes ø 6 mm) and self-sharpening stainless steel knife. Grater section featured by: polished aluminium inlet 140x75 mm - stainless steel roller - lower protection grid - microswitch on the grater pusher.

FR Corps en aluminium poli avec trémie en acier inox. Machine avec groupe de hachage entièrement amovible qui permet de pouvoir le placer dans le réfrigérateur - l'unité de hachage en acier inox AISI 304 peut être lavée au lave-vaisselle - **orifice d'entrée viande ø 52 mm** - motoréducteur à engrenages à bain d'huile. De série, système enterprise avec plaque en inox (trous ø 6 mm) et couteau inox aiguisement automatique. La partie de la râpe se caractérise par: orifice d'entrée en aluminium poli 140x75 mm - rouleau en acier inox - grille de protection inférieure - microrupteur à levier pour le bras pousseur.

DE Gehäuse aus poliertem Aluminium mit Trichter aus Edelstahl. Maschine mit Zerkleinerungseinheit, die vollständig abnehmbar ist und daher die Aufbewahrung im Kühlschrank gestattet - Hygienevorschriften von den Hackfleischrückständen gereinigt zu werden, die Zerkleinerungseinheit aus Edelstahl AISI 304 kann in der Geschirrspülmaschine gereinigt werden. **Fleischeinlassöffnung ø 52 mm** - Getriebemotor mit Ölbad - ausgestattet mit Enterprise-System mit Edelstahlplatte (Löcher ø 6 mm) und selbstschärfendem Edelmessermesser. Teile der Reibe: Einführöffnung aus poliertem Aluminium 140x75 mm - Rolle aus Edelstahl - unterer Schutzrost - Mikroschalter am Einfüllhebel der Reibe.

ES Carcasa de aluminio pulido con tolva de acero inoxidable. Máquina con grupo de picar completamente extraíble que permite poderlo colocar en la nevera. El grupo de picar de acero inoxidable AISI 304 puede ser limpiado en el lavavajillas - **boca para introducir la carne ø 52 mm** - reductor con engranajes en baño de aceite - en dotación sistema enterprise con placa de acero inoxidable (agujeros ø 6 mm) y cuchilla de acero inoxidable con autoafilado. La parte del rallador se caracteriza por: boca de aluminio pulido 140x75 mm - rodillo de acero inoxidable - rejilla inferior de protección - empujador con microinterruptor.

RU Корпус из полированного алюминия с воронкой из нержавеющей стали. Машина с полностью съемным измельчающим устройством, которое может храниться в холодильнике без предварительной очистки от мясного фарша после каждого использования в соответствии с гигиеническими нормами HACCP, узел измельчения из нержавеющей стали AISI 304 можно мыть в посудомоечной машине. **Мясоприемник ø 52 мм** - Привод с масляной ванной - Система Enterprise с решеткой из нержавеющей стали (отверстия ø 6 мм) и самозатачивающимся ножом из нержавеющей стали. Детали терки: приемный лоток из полированного алюминия 140x75 мм - цилиндр из нержавеющей стали - нижняя защитная решетка - микровыключатель на прижимном рычаге терки.

	<b>22ATE</b>	
	1,1 kW (1,5 HP)	
	230-400V/3N/50Hz	
	230V/1N/50Hz	
	 150÷250 Kg/h	 40 Kg/h
	560 x 430 x 480÷650(h) mm	
		
		
	38 Kg	
	48 Kg	
	770 x 520 x 580(h) mm	
	0,232 m³	

# 22T



52 mm



1,5 HP

## Abbinato Tritacarne e Grattugia

COMBINED MEAT MINCER AND GRATER  
HACHOIR À VIANDE ET RÂPE COMBINÉS  
PICADORA DE CARNE Y RALLADOR COMBINADOS  
KOMBINIERTER FLEISCHWOLF UND REIBE  
ДВОЙНАЯ ФУНКЦИЯ МЯСОРУБКИ И ТЕРКИ

IT Abbinato tritacarne grattugia. Struttura in alluminio lucidato con tramoggia in acciaio inox - gruppo macinazione estraibile in acciaio inox AISI 304 - **bocca ingresso carne ø 52 mm** - riduttore con ingranaggi a bagno d'olio - in dotazione sistema - enterprise con piastra inox (fori ø 6 mm) e coltello inox autoaffilante. La parte della grattugia è caratterizzata da: bocchain alluminio lucidato 140x75 mm - rullo in acciaio inox - griglia inferiore di protezione - microinterruttore leva pressore grattugia.













EN Combined meat mincer and grater - polished aluminium casing and stainless steel hopper. Removable grinding unit in stainless steel AISI 304 - **meat inlet ø 52 mm** - oiled gear motor. Equipped with enterprise system with stainless steel plate (holes ø 6 mm) and self-sharpening stainless steel knife. Grater section featured by: polished aluminium inlet 140x75 mm - stainless steel roller - lower protection grid - microswitch on the grater pusher.

FR Combinée hachoir à viande et râpe - Corps en aluminium poli et trémie en acier inox - groupe de hachage amovible en acier inox AISI 304 - **orifice d'entrée viande ø 52** - motoréducteur à engrenages à bain d'huile. De série, système enterprise avec plaque en inox (trous ø 6 mm) et couteau inox à aiguisement automatique. La partie de la râpe se caractérise par: orifice d'entrée en aluminium poli 140x75 mm - rouleau en acier inox - grille de protection inférieure - microrupteur à levier sour le bras pousseur.

DE Doppelfunktion Fleischwolf und Reibe - Gehäuse und Trichter aus Edelstahl - herausnehmbare Schneidegruppe aus Edelstahl AISI 304 - **Fleischeinführöffnung ø 52 mm** - Getriebemotor mit Ölbad - ausgestattet mit Enterprise-System mit Edelstahlplatte (Löcher 6 mm) und selbstschärfendem Edelstahlmesser. Teile der Reibe: Einführöffnung aus poliertem Aluminium 140x75 mm - Rolle aus Edelstahl - unterer Schutzrost - Mikroschalter am Einfüllhebel der Reibe.

ES Picadora de carne y rallador combinados. Estructura de aluminio pulido con tolva de acero inoxidable - grupo para picar de acero inoxidable (AISI 304) completamente extraíble - **boca de ø 52 mm para introducir la carne** - reductor con engranajes en baño de aceite - inversión de la marcha - en la dotación sistema enterprise con placa de acero inoxidable (agujeros ø 6 mm) y cuchilla de acero inoxidable con autoafilado. La parte del rallador se caracteriza por: boca de aluminio pulido 140x75 mm - rodillo de acero inoxidable - rejilla inferior de protección - empujador con microinterruptor.

RU Двойная функция мясорубки и терки - Корпус и воронка из нержавеющей стали - Съёмная режущая группа из нержавеющей стали AISI 304 - **Мясоприемник ø 52 мм** - Привод с масляной ванной - Система Enterprise с решеткой из нержавеющей стали (отверстия ø 6 мм) и самозатачивающимся ножом из нержавеющей стали. Детали терки: приемный лоток из полированного алюминия 140x75 мм - цилиндр из нержавеющей стали - нижняя защитная решетка - микровыключатель на прижимном рычаге терки.

	<b>22T</b>	
	1,1 kW (1,5 HP)	
	230-400V/3//50Hz	
	230V/1N/50Hz	
	 150÷250 Kg/h	 40 Kg/h
	630 x 305 x 510÷660(h) mm	
		
	26 Kg	
	29 Kg	
	750 x 300 x 520(h) mm	
	0,117 m³	

# 22AE



52 mm



1,5 HP



## Abbinato Tritacarne e Grattugia

COMBINED MEAT MINCER AND GRATER  
HACHOIR À VIANDE ET RÂPE COMBINÉS  
PICADORA DE CARNE Y RALLADOR COMBINADOS  
KOMBINIERTER FLEISCHWOLF UND REIBE  
ДВОЙНАЯ ФУНКЦИЯ МЯСОРУБКИ И ТЕРКИ

IT Struttura in alluminio lucidato con tramoggia in acciaio inox - gruppo di macinazione inox AISI 304 completamente removibile che permette di poterlo collocare in frigorifero - **bocca ingresso carne ø 52 mm** - riduttore con ingranaggi a bagno d'olio - in dotazione sistema enterprise con piastra inox (fori ø 6 mm) e coltello inox autoaffilante. La parte della grattugia è caratterizzata da: bocca in alluminio lucidato 140x75 mm - rullo in acciaio inox - griglia inferiore di protezione - microinterruttore leva pressore grattugia.

EN Machine with a completely removable grinding unit in stainless steel AISI 304 that allows it to be placed in the refrigerator - **meat inlet ø 52 mm** - oiled gear motor. Equipped with enterprise system with stainless steel plate (ø 6 mm) and self-sharpening stainless steel knife. Grater section featured by: polished aluminium inlet 140x75 mm - stainless steel roller - lower protection grid - microswitch on the grater pusher.

FR Corps en aluminium poli avec trémie en acier inox - Machine avec groupe de hachage entièrement amovible en acier inox AISI 304 qui permet de pouvoir le placer dans le réfrigérateur - **orifice d'entrée viande ø 52 mm** - motoréducteur à engrenages à bain d'huile. De série, système enterprise avec plaque en inox (ø 6 mm) et couteau inox à aiguisement automatique. La partie de la râpe se caractérise par: orifice d'entrée en aluminium poli 140x75 mm - rouleau en acier inox - grille de protection inférieure - microrupteur à levier sour le bras pousseur.

DE Poliertes Aluminiumgehäuse mit Edelstahltrichter. Maschine mit Zerkleinerungseinheit aus Edelstahl AISI 304, die vollständig abnehmbar ist und daher die Aufbewahrung im Kühlschrank gestattet - Hygienevorschriften von den Hackfleischrückständen gereinigt zu werden. **Fleischeinführöffnung ø 52 mm** - Getriebemotor mit Ölbad - ausgestattet mit Enterprise-System mit Edelstahlplatte (6 mm) und selbstschärfendem Edelmesser. Teile der Reibe: Einführöffnung aus poliertem Aluminium 140x75 mm - Rolle aus Edelstahl - unterer Schutzrost - Mikroschalter am Einfüllhebel der Reibe.

ES Estructura de aluminio pulido con tolva de acero inoxidable - grupo para picar de acero inoxidable (AISI 304) completamente extraíble que permite poderlo colocar en la nevera - **boca de ø 52 mm para introducir la carne** - reductor con engranajes en baño de aceite - en la dotación sistema enterprise con placa de acero inoxidable (ø 6 mm) y cuchilla de acero inoxidable con autoafilado. La parte del rallador se caracteriza por: boca de aluminio pulido 140x75 mm - rodillo de acero inoxidable - rejilla inferior de protección - empujador con microinterruptor.

RU Корпус из полированного алюминия с воронкой из нержавеющей стали. Машина с измельчения из нержавеющей стали AISI 304 с полностью съемным измельчающим устройством, которое может храниться в холодильнике без предварительной очистки от мясного фарша после каждого использования в соответствии с гигиеническими нормами HACCP. **Мясоприемник ø 52 мм** - Привод с масляной ванной - Система Enterprise с решеткой из нержавеющей стали (ø 6 мм) и самозатачивающимся ножом из нержавеющей стали. Детали терки: приемный лоток из полированного алюминия 140x75 мм - цилиндр из нержавеющей стали - нижняя защитная решетка - микровыключатель на прижимном рычаге терки.

	<b>22AE</b>	
	1,1 kW (1,5 HP)	
	230-400V/3N/50Hz	
	230V/1N/50Hz	
	 150÷250 Kg/h	 40 Kg/h
	630 x 305 x 510÷660(h) mm	
		
	27 Kg	
	30 Kg	
	750 x 300 x 520(h) mm	
	0,117 m³	

# 12AT



52 mm



1 HP



## Abbinato Tritacarne e Grattugia

COMBINED MEAT MINCER AND GRATER  
HACHOIR À VIANDE ET RÂPE COMBINÉS  
PICADORA DE CARNE Y RALLADOR COMBINADOS  
KOMBINIERTER FLEISCHWOLF UND REIBE  
ДВОЙНАЯ ФУНКЦИЯ МЯСОРУБКИ И ТЕРКИ



IT Struttura in alluminio lucidato con tramoggia in acciaio inox - gruppo di macinazione inox AISI 304 completamente removibile che permette di poterlo collocare in frigorifero - **bocca ingresso carne ø 52 mm** - riduttore con ingranaggi a bagno d'olio - in dotazione sistema enterprise con piastra inox (ø 6 mm) e coltello inox autoaffilante. La parte della grattugia è caratterizzata da: bocca in alluminio lucidato 140x75 mm - rullo in acciaio inox - griglia inferiore di protezione - microinterruttore leva pressore grattugia.













EN Machine with a completely removable grinding unit in stainless steel AISI 304 that allows it to be placed in the refrigerator - **meat inlet ø 52 mm** - oiled gear motor. Equipped with enterprise system with stainless steel plate (ø 6 mm) and self-sharpening stainless steel knife. Grater section featured by: polished aluminium inlet 140x75 mm - stainless steel roller - lower protection grid - microswitch on the grater pusher.

FR Corps en aluminium poli avec trémie en acier inox - Machine avec groupe de hachage entièrement amovible en acier inox AISI 304 qui permet de pouvoir le placer dans le réfrigérateur. - **orifice d'entrée viande ø 52 mm** - motoréducteur à engrenages à bain d'huile. De série, système enterprise avec plaque en inox (ø 6 mm) et couteau inox à aiguisement automatique. La partie de la râpe se caractérise par: orifice d'entrée en aluminium poli 140x75 mm - rouleau en acier inox - grille de protection inférieure - microrupteur à levier sour le bras pousseur.

DE Poliertes Aluminiumgehäuse mit Edelstahltrichter. Maschine mit Zerkleinerungseinheit aus Edelstahl AISI 304, die vollständig abnehmbar ist und daher die Aufbewahrung im Kühlschrank gestattet - Hygienevorschriften von den Hackfleischrückständen gereinigt zu werden. **Fleischeinführöffnung ø 52 mm** - Getriebemotor mit Ölbad - ausgestattet mit Enterprise-System mit Edelstahlplatte (6 mm) und selbstschärfendem Edelmessermesser. Teile der Reibe: Einführöffnung aus poliertem Aluminium 140x75 mm - Rolle aus Edelstahl - unterer Schutzrost - Mikroschalter am Einfüllhebel der Reibe.

ES Estructura de aluminio pulido con tolva de acero inoxidable - grupo para picar de acero inoxidable (AISI 304) completamente extraíble que permite poderlo colocar en la nevera - **boca de ø 52 mm para introducir la carne** - reductor con engranajes en baño de aceite - en la dotación sistema enterprise con placa de acero inoxidable (ø 6 mm) y cuchilla de acero inoxidable con autoafilado. La parte del rallador se caracteriza por: boca de aluminio pulido 140x75 mm - rodillo de acero inoxidable - rejilla inferior de protección - empujador con microinterruptor.

RU Корпус из полированного алюминия с воронкой из нержавеющей стали. Машина с измельчения из нержавеющей стали AISI 304 с полностью съемным измельчающим устройством, которое может храниться в холодильнике без предварительной очистки от мясного фарша после каждого использования в соответствии с гигиеническими нормами HACCP. **Мясоприемник ø 52 мм** - Привод с масляной ванной - Система Enterprise с решеткой из нержавеющей стали (ø 6 мм) и самозатачивающимся ножом из нержавеющей стали. Детали терки: приемный лоток из полированного алюминия 140x75 мм - цилиндр из нержавеющей стали - нижняя защитная решетка - микровыключатель на прижимном рычаге терки.

	<b>12AT</b>	
	0,75 kW (1 HP)	
	230-400V/3/50Hz	
	230V/1N/50Hz	
	 100÷160 Kg/h	 40 Kg/h
	605 x 305 x 510÷600(h) mm	
		
	26 Kg	
	30 Kg	
	750 x 300 x 520(h) mm	
	0,117 m³	

# 12T



52 mm



1 HP

## Abbinato Tritacarne e Grattugia

COMBINED MEAT MINCER AND GRATER  
HACHOIR À VIANDE ET RÂPE COMBINÉS  
PICADORA DE CARNE Y RALLADOR COMBINADOS  
KOMBINIERTER FLEISCHWOLF UND REIBE  
ДВОЙНАЯ ФУНКЦИЯ МЯСОРУБКИ И ТЕРКИ

IT Abbinato tritacarne e grattugia. Struttura in alluminio lucidato con tramoggia in acciaio inox - gruppo di macinazione estraibile in acciaio inox AISI 304 - **bocca ingresso carne ø 52 mm** - riduttore con ingranaggi a bagno d'olio - in dotazione sistema enterprise con piastra inox (fori ø 6 mm) e coltello inox autoaffilante - la parte della grattugia è caratterizzata da bocca in alluminio lucidato 140x75 mm - rullo in acciaio inox - griglia inferiore di protezione - microinterruttore leva pressore grattugia.













EN Combined meat mincer and grater - polished aluminium casing and stainless steel hopper. Removable grinding unit in stainless steel AISI 304 - **meat inlet ø 52 mm** - oiled gear motor. Equipped with enterprise system with stainless steel plate (holes ø 6 mm) and self-sharpening stainless steel knife. Grater section featured by: polished aluminium inlet 140x75 mm - stainless steel roller - lower protection grid - microswitch on the grater pusher.

FR Combinée hachoir à viande et râpe - Corps en aluminium poli et trémie en acier inox - groupe de hachage amovible en acier inox AISI 304 - **orifice d'entrée viande ø 52** - motoréducteur à engrenages à bain d'huile. De série, système enterprise avec plaque en inox (trous ø 6 mm) et couteau inox à aiguisement automatique. La partie de la râpe se caractérise par: orifice d'entrée en aluminium poli 140x75 mm - rouleau en acier inox - grille de protection inférieure - microrupteur à levier sous le bras pousseur.

DE Doppelfunktion Fleischwolf und Reibe - Gehäuse aus poliertem Aluminium und Trichter aus Edelstahl - herausnehmbare Schneidegruppe aus Edelstahl AISI 304 - **Fleischeinführöffnung ø 52 mm** - Getriebemotor mit Ölbad - ausgestattet mit Enterprise-System mit Edelstahlplatte (Löcher 6 mm) und selbstschärfendem Edelmessers. Teile der Reibe: Einführöffnung aus poliertem Aluminium 140x75 mm - Rolle aus Edelstahl - unterer Schutzrost - Mikroschalter am Einfüllhebel der Reibe.

ES Picadora de carne y rallador combinados. Estructura de aluminio pulido con tolva de acero inoxidable - grupo para picar de acero inoxidable (AISI 304) completamente extraíble - **boca de ø 52 mm para introducir la carne** - reductor con engranajes en baño de aceite - en la dotación sistema enterprise con placa de acero inoxidable (agujeros ø 6 mm) y cuchilla de acero inoxidable con autoafilado. La parte del rallador se caracteriza por: boca de aluminio pulido 140x75 mm - rodillo de acero inoxidable - rejilla inferior de protección - empujador con microinterruptor.

RU Двойная функция мясорубки и терки - Корпус и воронка из нержавеющей стали - Съёмная режущая группа из нержавеющей стали AISI 304 - **Мясоприемник ø 52 мм** - Привод с масляной ванной - Система Enterprise с решеткой из нержавеющей стали (отверстия ø 6 мм) и самозатачивающимся ножом из нержавеющей стали. Детали терки: приемный лоток из полированного алюминия 140x75 мм - цилиндр из нержавеющей стали - нижняя защитная решетка - микровыключатель на прижимном рычаге терки.

	<b>12T</b>	
	0,75 kW (1 HP)	
	230-400V/3/50Hz	
	230V/1N/50Hz	
	 100÷160 Kg/h	 40 Kg/h
	590 x 290 x 510÷600(h) mm	
		
	23 Kg	
	26 Kg	
	750 x 300 x 520(h) mm	
	0,117 m³	





# GR12S



# Grattugia

GRATER  
RAPE  
KÄSEREIBE  
RALLADOR  
ТЕПКА

- IT** Struttura e bocca in alluminio lucidato - dimensione della bocca 140x75 mm - rullo in acciaio inox - griglia inferiore di protezione - microinterruttore leva pressore grattugia - versione CE con freno motore.
- EN** Polished aluminium casing and inlet - inlet size 140x75 mm - stainless steel roller - lower protection grid - grater presser lever switch - CE version with motor brake.
- FR** Corps et orifice en aluminium poli - dimensions de l'orifice 140x75 mm - rouleau en acier inox - grille inférieure de protection - micro-interrupteur bras pousseur râpe - version CE avec frein moteur.
- DE** Gehäuse und Einführöffnung aus poliertem Aluminium - Einführöffnungsgröße 140x75 mm - Rolle aus Edelstahl - unterer Schutzrost - Mikroschalter am Hebel des Reibniederhalters - CE-Version mit Motorbremse.
- ES** Estructura y boca de aluminio pulido - tamaño de boca de inserción 140x75 mm - rodillo de acero inoxidable - rejilla inferior de protección - microinterruptor palanca prensador rallador - versión CE con freno motor.
- RU** Корпус и мясоприемник из полированного алюминия, размеры мясоприемник 140x75 мм ролик из нержавеющей стали, нижняя защитная решетка, микровыключатель на прижимном рычаге терки, исполнение CE с тормозом двигателя.

 <b>GR12S</b>	
	0,75 kW (1 HP)
 3 Ph	230-400V/3/50Hz
 1 Ph	230V/1N/50Hz
 Kg/h	40 Kg/h
	430 x 290 x 390÷600(h) mm
	
 NET Kg	17 Kg
 GROSS Kg	19 Kg
 mm	470 x 300 x 520(h) mm
 m <sup>3</sup>	0,073 m <sup>3</sup>

# AB8D



52 mm



0,5 HP

**Abbinato**  
Tritacarne e Grattugia

COMBINED MEAT MINCER AND GRATER  
HACHOIR À VIANDE ET RÂPE COMBINÉS  
PICADORA DE CARNE Y RALLADOR COMBINADOS  
KOMBINIERTER FLEISCHWOLF UND REIBE  
ДВОЙНАЯ ФУНКЦИЯ МЯСОРУБКИ И ТЕРКИ

**SEMIPROFESSIONAL**

IT Struttura in alluminio lucidato con tramoggia in acciaio inox - gruppo macinazione in alluminio - **bocca ingresso carne ø 52 mm** - in dotazione sistema enterprise con piastra inox (fori ø 6 mm) e coltello inox autoaffilante. La parte della grattugia è caratterizzata da: bocca in alluminio lucidato 105x65 mm - rullo in acciaio inox - griglia inferiore di protezione - microinterruttore leva pressore grattugia.

EN Polished aluminium casing and stainless steel hopper. Aluminium grinding unit - **meat inlet ø 52 mm**. Equipped with enterprise system with stainless steel plate (holes ø 6 mm) and self-sharpening stainless steel knife. Grater section featured by: polished aluminium inlet 105x65 mm - stainless steel roller - lower protection grid - microswitch on the grater pusher.

FR Corps en aluminium poli et trémie en acier inox - groupe de hachage en aluminium - **orifice d'entrée viande ø 52 mm**. De série, système enterprise avec plaque en inox (trous ø 6 mm) et couteau inox à aiguisement automatique. La partie de la râpe se caractérise par: orifice d'entrée en aluminium poli 105x65 mm - rouleau en acier inox - grille de protection inférieure - microrupteur à levier sur le bras pousseur.

DE Gehäuse aus poliertem Aluminium und Trichter aus Edelstahl - Schneidegruppe aus Aluminium - **Fleischeinführöffnung ø 52 mm** - ausgestattet mit Enterprise-System mit Edelstahlplatte (Löcher ø 6 mm) und selbstschärfendem Edelmesser. Teile der Reibe: Einführöffnung aus poliertem Aluminium 105x65 mm - Rolle aus Edelstahl - unterer Schutzrost - Mikroschalter am Einfüllhebel der Reibe.

ES Estructura de aluminio pulido con tolva de acero inoxidable - grupo para picar de aluminio - **boca para introducir la carne ø 52 mm** - en la dotación sistema enterprise con placa de acero inoxidable (agujeros ø 6 mm) y cuchilla de acero inoxidable con autoafilado. La parte del rallador se caracteriza por: boca de aluminio pulido 105x65 mm - rodillo de acero inoxidable - rejilla inferior de protección - empujador con microinterruptor.

RU Корпус и воронка из нержавеющей стали - Режущий узел из алюминия - **Мясоприемник ø 52 мм** - Система Enterprise с решеткой из нержавеющей стали (отверстия ø 6 мм) и самозатачивающимся ножом из нержавеющей стали. Детали терки: приемный лоток из полированного алюминия 105x65 мм - цилиндр из нержавеющей стали - нижняя защитная решетка - микровыключатель на прижимном рычаге терки.

	<b>AB8D</b>	
	0,37 kW (0,5 HP)	
	230V/1N/50Hz	
	 20÷50 Kg/h	 20 Kg/h
	430 x 270 x 360÷420(h) mm	
		
	11 Kg	
	12 Kg	
	390 x 310 x 370(h) mm	
	0,045 m <sup>3</sup>	

TR8D  
GR8D



GR8D



TR8D

Tritacarne-grattugia

MEAT MINCER - GRATER  
HACHE-VIANDE ET RAPE  
FLEISCHWOLF UND KÄSEREIBE  
PICADORA DE CARNE - RALLADOR  
МЯСОРУБКА - ТЕРКА

**SEMI PROFESSIONAL**



IT **TR8D:** struttura in alluminio lucidato con tramoggia in acciaio inox - gruppo macinazione in alluminio - **bocca ingresso carne ø 52 mm** - riduttore con ingranaggi a bagno d'olio - in dotazione sistema enterprise con piastra inox (fori ø 6 mm) e coltello inox auto-affilante.

**GR8D:** Struttura e bocca in alluminio lucidato 105x65 mm - rullo in acciaio inox - griglia inferiore di protezione - microinterruttore leva pressore grattugia.

EN **TR8D:** polished aluminium casing and stainless steel hopper. Aluminium grinding unit - **meat inlet ø 52 mm** - oiled gear motor - equipped with enterprise system with stainless steel plate (holes ø 6 mm) and self-sharpening stainless steel knife.

**GR8D:** polished aluminium structure and inlet 105x65 mm - stainless steel roller - lower protection grid - microswitch on the grater pusher.

FR **TR8D:** corps en aluminium poli et trémie en acier inox - groupe de hachage en aluminium - **orifice d'entrée viande ø 52 mm** - motoréducteur à engrenages à bain d'huile. De série, système enterprise avec plaque en inox (trous ø 6 mm) et couteau inox à aiguisement automatique.

**GR8D:** corps et orifice d'entrée en aluminium poli 105x65 mm - rouleau en acier inox - grille de protection inférieure - microrupteur à levier pour le bras pousseur.

DE **TR8D:** Gehäuse aus poliertem Aluminium mit Trichter aus Edelstahl - Schneidegruppe aus Aluminium - **Fleischeinführöffnung ø 52 mm** - Getriebemotor mit Ölbad - ausgestattet mit Enterprise-System mit Edelstahlplatte (Löcher ø 6 mm) und selbstschärfendem Edelmessers.













**GR8D:** Struktur und Einführöffnung aus poliertem Aluminium 105x65 mm - Rolle aus Edelstahl - unterer Schutzrost - Mikroschalter am Einführhebel der Reibe.

ES **TR8D:** estructura de aluminio pulido con tolva de acero inoxidable - grupo para picar de aluminio - **boca para introducir la carne ø 52 mm** - en la dotación sistema enterprise con placa de acero inoxidable (agujeros ø 6 mm) y cuchilla de acero inoxidable con autoafilado.

**GR8D:** estructura y boca de aluminio pulido 105x65 mm - rodillo de acero inoxidable - rejilla inferior de protección - empujador con microinterruptor.

RU **TR8D:** Корпус из полированного алюминия с воронкой из нержавеющей стали - Режущий узел из алюминия - **Мясоприемник ø 52 мм** - Привод с масляной ванной - Система Enterprise с решеткой из нержавеющей стали (отверстия ø 6 мм) и самозатачивающимся ножом из нержавеющей стали.

**GR8D:** Корпус и мясоприемник из полированного алюминия 105x65 мм - цилиндр из нержавеющей стали - нижняя защитная решетка - микровыключатель на прижимном рычаге терки.

	TR8D	GR8D
	0,37 kW (0,5 HP)	
	230V/1N/50Hz	
	230V/1N/50Hz	
	 20÷50 Kg/h	 20 Kg/h
	290 x 270 x 350(h) mm	290 x 250 x 310÷420(h) mm
		
	9 Kg	8 Kg
	10 Kg	9 Kg
	320 x 270 x 380(h) mm	
	0,033 m³	

## SISTEMA UNGER STANDARD

STANDARD UNGER SYSTEM  
 SYSTÈME UNGER STANDARD  
 STANDARD UNGERSYSTEM  
 SISTEMA UNGER ESTÁNDAR  
 СТАНДАРТНАЯ СИСТЕМА UNGER

A) Corpo tritacarne  
 Mincer body  
 Corps hache-viande  
 Fleischwolfkörper  
 Cuerpo picadora de carne  
 Корпус мясорубки

D) Coltello  
 Blade  
 Couteau  
 Messer  
 Cuchilla  
 Нож

B) Coclea  
 Screw conveyor  
 Vis transporteuse  
 Förderschnecke  
 Tornillo sinfín  
 Шнек

E) Piastra ø8  
 Plate ø8  
 Grille ø8  
 Lochscheibe ø8  
 Placa ø8  
 Решетка ø8

C) Piastra sgrossatrice 0  
 Large grater plate 0  
 Grille dégrossisseuse 0  
 Grob-Lochscheibe 0  
 Placa para desbastar 0  
 Крупная подрезная  
 решетк 0

F) Piastra ø4.5  
 Plate ø4.5  
 Grille ø4.5  
 Lochscheibe ø4.5  
 Placa ø4.5  
 Решетка ø4.5

G) Volantino  
 Handwheel  
 Manivelle  
 Handrad  
 Volante  
 Рукоятка мясорубки

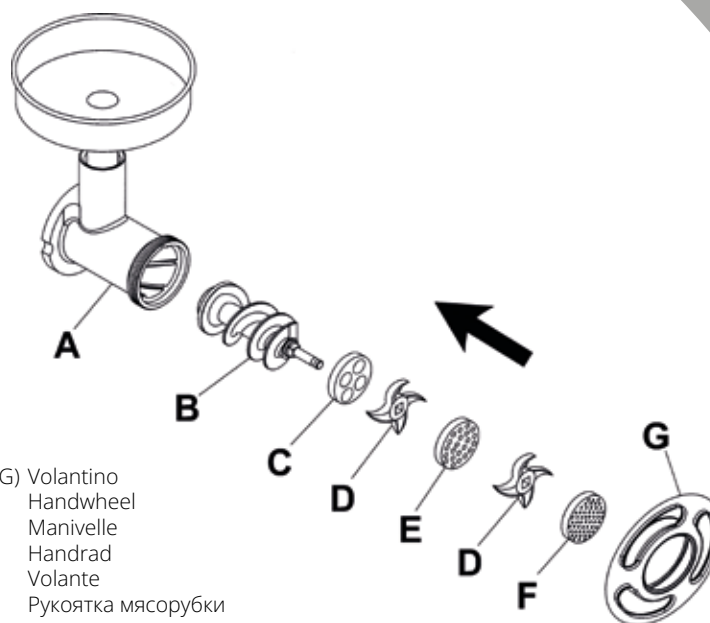

Mod. 12  
 Passapomodoro  
 Tomato Pulper  
 Passe-Tomates  
 Tomatenpürierer  
 Pasador de tomate  
 Насадка для томатов



ø 15-20-30 mm  
 Imbuto tritacarne  
 Mincer funnel  
 Entonnoir pour hachoir à viande  
 Fleischwoltrichter  
 Embudo para picadora de carne  
 Воронка для мяса



Optional  
 Tritacarne e Abbinati

ACCESSORIES  
 ACCESSOIRES  
 ZUBEHÖR  
 ACCESORIOS  
 АКЦЕССУАРИ

Piastre Unger in acciaio inox - Unger stainless steel perforated disks Grilles Unger en acier inox - Unger Edelstahllochscheiben Placas Unger de acero inoxidable - Решетки Unger Инокс							
Mod.					Piastra sgrossatrice 0 Large grater plate 0 Grille dégrossisseuse 0 Grob-Lochscheibe 0 Placa para desbastar 0 Решетка крупная 0	Coltelli Unger in acciaio inox Unger stainless steel knives Couteaux Unger en acier inox Unger Edelmessermesser Cuchillas Unger de acero inoxidable Ножи "Unger" из нержавеющей стали	
	∅ mm 2-2.5	∅ mm 3-3.5-4	∅ mm 4.5-6-8	∅ mm 10-12-14-16-18-20			
8							
12 (R70)							
22 (H82)							
32 (B98)							

Piastre Enterprise in acciaio inox - Enterprise stainless steel perforated disks Grilles Enterprise en acier inox- Enterprise Edelstahllochscheiben Placas Enterprise de acero inoxidable - Решетки Enterprise Инокс							
Mod.					Coltelli enterprise in acciaio inox Enterprise stainless steel knives Couteaux enterprise en acier inox Enterprise messer aus Edelstahl Cuchillas enterprise de acero inoxidable Ножи "enterprise" из нержавеющей стали		
	∅ mm 2	∅ mm 3-3.5-4	∅ mm 4.5-6-8	∅ mm 10-12-14-16-18-20			
8							
12 (R70)							
22 (H82)							
32 (B98)							

Mod.	Imbuto tritacarne - Mincer funnel - Entonnoir pour hachoir à viande Fleischwoltrichter - Embudo para picadora de carne - Воронка для мяса
8	∅ 15-20 mm
12	∅ 15-20 mm
22	∅ 15-20-30 mm
32	∅ 20-30 mm

Mod.	Passapomodoro - Passaverdura Vegetable mill and Tomato Pulper Passe-Tomates et moulin à légumes Tomatenpürierer und Gemüsepassiermühle Pasador de tomate y verduras Насадка для томатов и фруктов
12	

SE1550A  
SE1830A  
SE2020A



SE1830A

Segaossi a nastro  
anodizzato

ANODIZED BONE BANDSAW  
SCIÉ À OS ANODISÉE  
LACKIERTE KNOCHENBANDSÄGE  
SIERRAS ANODIZADA PARA HUESOS CON CINTA  
АНОДИРОВАННЫЙ ЛЕНТОЧНАЯ ПИЛА ДЛЯ КОСТЕЙ

**IT Struttura in alluminio anodizzato** - pulsante di emergenza - microinterruttore su coperchio di chiusura macchina - freno motore - regolazione dello spessore di taglio - regolazione dell'altezza di taglio - porzionatore, piano di lavoro, guida lama e spingi carne in acciaio inox.  
Accessori: cavalletto in acciaio verniciato - confezione di lame.





**EN Anodised aluminium structure** - emergency stop button - microswitch on the machine lid - motor brake - cutting thickness adjustment - cutting height adjustment - stainless steel portioning device, work surface, knife guide and meat pusher.  
Accessories: Painted steel stand - set of blades.

**FR Corps en aluminium anodisé** - bouton d'arrêt d'urgence - micro-interrupteur sur le couvercle de la machine - frein moteur - réglage de l'épaisseur de coupe - réglage de la hauteur de coupe - dispositif de portionnement, plan de travail, guide couteau et pousoir de viande en acier inox.  
Accessoires : Support en acier verni - jeu de lames.

**DE Gehäuse aus eloxiertem Aluminium** - Notaus-Schalter - Mikroschalter auf Maschinenverschlussdeckel - Motorbremse - Einstellung der Schnittdicke - Einstellung der Schnitthöhe - Portioniervorrichtung, Arbeitsfläche, Messerführung und Fleischschieber aus Edelstahl.  
Zubehör: Gestell aus lackiertem Stahl - Messersatz.

**ES Estructura de aluminio anodizado** - botón de emergencia - microinterruptor en la tapa de cierre de la máquina - freno motor - regulación del espesor del corte - regulación de la altura del corte - porcionadora, superficie de trabajo, guía cuchilla y empuja carne de acero inoxidable.  
Accesorios: Caballete de acero pintado - paquete de cuchillas.

**RU Корпус из анодированного алюминия** - Аварийный выключатель - Микропереключатель на крышке машины - Моторный тормоз - Регулировка толщины резки - регулировка высоты резки - порционирующее устройство, рабочая поверхность, направляющая лезвия и пестик для мяса из нержавеющей стали.  
Аксессуары: Рама из лакированной стали - набор ножей.

	SE1550A	SE1830A	SE2020A
	0,75 kW (1 HP)		1 kW (1,5 HP)
	230-400V/3/50Hz		
	230V/1N/50Hz		
	ø 1550 mm 170 x 150(h) mm	ø 1830 mm 200 x 225(h) mm	ø 2020 mm 230 x 290(h) mm
	330 x 300 mm	410 x 410 mm	535 x 500 mm
	530 x 400 x 850(h) mm	630 x 450 x 970(h) mm	750 x 500 x 1070(h) mm
			
	37 Kg	39 Kg	52 Kg
	45 Kg	47 Kg	63 Kg
	1020 x 560 x 500(h) mm		1150 x 560 x 570(h) mm
	0,286 m <sup>3</sup>		0,387 m <sup>3</sup>



CAVSE - CAVALLETTO VERNICIATO  
PAINTED STEEL STAND  
РАМА ИЗ ЛАКИРОВАННОЙ СТАЛИ

SE1550V  
SE1830V  
SE2020V



SE1830V

# Segaossi a nastro verniciato

COATED BONE BANDSAW  
SCIE À OS PEINTE  
LACKIERTE KNOCHENBANDSÄGEN  
SIERRAS PARA HUESOS CON CINTA PINTADO  
ЛЕНТОЧНЫЕ ПИЛЫ ДЛЯ РАСПИЛА  
КОСТЕЙ ОКРАШЕННЫЙ

**IT Struttura in alluminio verniciato** - pulsante di emergenza - microinterruttore su coperchio di chiusura macchina - freno motore - regolazione dello spessore di taglio - regolazione dell'altezza di taglio - porzionatore, piano di lavoro, guida lama e spingi carne in acciaio inox.  
Accessori: cavalletto in acciaio verniciato, confezione di lame.

**EN Painted aluminium structure** - emergency stop button - microswitch on the machine lid - motor brake - cutting thickness adjustment - cutting height adjustment - stainless steel portioning device, work surface, knife guide and meat pusher.  
Accessories: Painted steel stand, Pack of blades.

**FR Corps en aluminium peint** - bouton d'arrêt d'urgence - micro-interrupteur sur le couvercle de la machine - frein moteur - réglage de l'épaisseur de coupe - réglage de la hauteur de coupe - dispositif de portionnement, plan de travail, guide couteau et pousoir de viande en acier inox.  
Accessoires: Support en acier verni, Paquet de lames.

**DE Gehäuse aus lackiertem Aluminium** - Notaus-Schalter - Mikroschalter auf Maschinenverschlussdeckel - Motorbremse - Einstellung der Schnittdicke - Einstellung der Schnitthöhe - Portioniervorrichtung, Arbeitsfläche, Messerführung und Fleischschieber aus Edelstahl.  
Zubehör: Gestell aus lackiertem Stahl, Klinge-Packung.

**ES Estructura de aluminio pintado** - botón de emergencia - microinterruptor en la tapa de cierre de la máquina - freno motor - regulación del espesor del corte - regulación de la altura del corte - porcionadora, superficie de trabajo, guía cuchilla y empuja carne de acero inoxidable.  
Accesorios: Caballete de acero pintado, Paquete de cuchillas.

**RU Корпус из окрашенного алюминия** - Аварийный выключатель - Микропереключатель на крышке машины - Моторный тормоз - Регулировка толщины резки - регулировка высоты резки - порционирующее устройство, рабочая поверхность, направляющая лезвия и пестик для мяса из нержавеющей стали.  
Аксессуары: Рама из окрашенной стали, Набор лезвий.

	SE1550V	SE1830V	SE2020V
	0,75 kW (1 HP)		1 kW (1,5 HP)
	230-400V/3/50Hz		
	230V/1N/50Hz		
	ø 1550 mm 170 x 150(h) mm	ø 1830 mm 200 x 225(h) mm	ø 2020 mm 230 x 290(h) mm
	330 x 300 mm	410 x 410 mm	535 x 500 mm
	530 x 400 x 850(h) mm	630 x 450 x 970(h) mm	750 x 500 x 1070(h) mm
			
	37 Kg	39 Kg	52 Kg
	45 Kg	47 Kg	63 Kg
	1020 x 560 x 500(h) mm		1150 x 560 x 570(h) mm
	0,286 m <sup>3</sup>		0,387 m <sup>3</sup>



CAVSE - CAVALLETTO VERNICIATO  
PAINTED STEEL STAND  
РАМА ИЗ ЛАКИРОВАННОЙ СТАЛИ

30C1PN  
50C1PN  
50C2PN

New



50C1PN



30C1PN

Impastatrici per carne

MEAT MIXER  
MELANGEUR À VIANDE  
FLEISCH MISCHMASCHINEN  
AMASADORAS PARA CARNE  
ФАРШЕМЕШАЛКИ



- IT Impastatrici per carne. **Struttura interamente in acciaio inox sabbiato** - microinterruttore su coperchio - inversione di marcia - pulsante di emergenza - ribaltamento della vasca (110°) per facilitarne lo svuotamento - pale estraibili - kit ruote (di cui 2 con freno) di serie.
- EN Meat kneader. **Sanded stainless steel structure** - micro switch on lid - reverse function - emergency stop button - tank tilting (110°) for easy emptying - removable blades. Wheel kit (2 of which with brake) as standard.
- FR Mélangeurs de viande. **Corps entièrement en acier inox sablé** - micro-interrupteur sur le couvercle - inversion de marche - bouton d'arrêt d'urgence - cuve basculante (110°) pour faciliter le vidage - lames amovibles - kit roue (dont 2 avec frein) de série.
- DE Fleischmixer. **Gehäuse komplett aus sandgestrahltem Edelstahl** - Mikroschalter am Deckel - Umkehrgetriebe - Notaus-Schalter - Wannenkipfung (110°) zur Entleerungserleichterung - herausnehmbare Schaufeln. Radsatz (davon 2 mit Bremse) serienmäßig.
- ES Amasadoras de carne. **Estructura completamente de acero inoxidable arenado** - microinterruptor con tapa - inversión de la marcha - botón de emergencia - el recipiente se puede volcar (110°) para facilitar su vaciado - palas extraíbles. Kit de ruedas (2 con freno) en el equipamiento de serie.
- RU Мясной смеситель. **Корпус из нержавеющей стали с пескоструйной обработкой** - Микропереключатель на крышке машины - Реверс - Аварийный выключатель - Наклон трубы (110°) облегчение опорожнения - съемные лопасти. Колесная пара (2 с тормозом) в стандартной комплектации.



PALE ESTRAIBILI  
REMOVABLE BLADES  
СЪЕМНЫЕ ЛОПАСТИ

	30C1PN	50C1PN	50C2PN
	0,75 kW (1 HP)		1,5 kW (2 HP)
	230-400V/3/50Hz		
	230V/1N/50Hz		-
	25-30 Kg	40-50 Kg	
	380 x 300 x 390(h) mm	415 x 390 x 470(h) mm	415 x 500 x 385(h) mm
	30 rpm		
	700 x 420 x 1025(h) mm	800 x 570 x 1031(h) mm	
	1	1	2
	40 Kg	80 Kg	100 Kg
	65 Kg	90 Kg	117 Kg
	830 x 550 x 1060(h) mm	1220 x 670 x 1150(h) mm	
	0,048 m³	0,940 m³	

75C1PN-95C2PN  
115C2PN-150C2PN

New



115C2PN

Impastatrici per carne

MEAT MIXER  
MELANGEUR À VIANDE  
FLEISCH MISCHMASCHINEN  
AMASADORAS PARA CARNE  
ФАРШЕМЕШАЛКИ

- IT Impastatrici per carne. **Struttura interamente in acciaio inox sabbiato** - microinterruttore su coperchio - inversione di marcia - pulsante di emergenza - ribaltamento della vasca (110°) per facilitarne lo svuotamento - pale estraibili - kit ruote (di cui 2 con freno) di serie.
- EN Meat kneader. **Sanded stainless steel structure** - micro switch on lid - reverse function - emergency stop button - tank tilting (110°) for easy emptying - removable blades. Wheel kit (2 of which with brake) as standard.
- FR Mélangeurs de viande. **Corps entièrement en acier inox sablé** - micro-interrupteur sur le couvercle - inversion de marche - bouton d'arrêt d'urgence - cuve basculante (110°) pour faciliter le vidage - lames amovibles - kit roue (dont 2 avec frein) de série.
- DE Fleischmischer. **Gehäuse komplett aus sandgestrahltem Edelstahl** - Mikroschalter am Deckel - Umkehrgetriebe - Notaus-Schalter - Wannenkipfung (110°) zur Entleerungserleichterung - herausnehmbare Schaufeln. Radsatz (davon 2 mit Bremse) serienmäßig.
- ES Amasadoras de carne. **Estructura completamente de acero inoxidable arenado** - microinterruptor con tapa - inversión de la marcha - botón de emergencia - el recipiente se puede volcar (110°) para facilitar su vaciado - palas extraíbles. Kit de ruedas (2 con freno) en el equipamiento de serie.
- RU Мясной смеситель. **Корпус из нержавеющей стали с пескоструйной обработкой** - Микропереключатель на крышке машины - Реверс - Аварийный выключатель - Наклон трубы (110°) облегчение опорожнения - съемные лопасти. Колесная пара (2 с тормозом) в стандартной комплектации.



PULSANTIERA  
PUSHBUTTON

	75C1PN	95C2PN	115C2PN	150C2PN
	1,5 kW (2 HP)		1,8 kW (2,5 HP)	
	230-400V/3/50Hz			
	65 - 75 Kg	85 - 95 Kg	105 - 115 Kg	140 - 150 Kg
	630 x 390 x 475(h) mm	790 x 500 x 385(h) mm	697 x 550 x 475(h) mm	875 x 550 x 475(h) mm
	30 rpm			
	980 x 520 x 1145(h) mm	1160 x 570 x 1031(h) mm	1090 x 640 x 1126(h) mm	1260 x 630 x 1126(h) mm
	1	2		
	85 Kg	110 Kg	115 Kg	120 Kg
	95 Kg	127 Kg	132 Kg	140 Kg
	1220 x 680 x 1150(h) mm			
	0,950 m <sup>3</sup>			

# LT7OR-LT7VE LT14OR-LT14VE



LT14VE



LT7OR

Insaccatrici manuali

MANUAL STAINLESS STEEL  
SAUSAGE FILLERS  
POUSOIRS À SAUCISSES MANUELS  
MANUELLE WURSTFÜLLMASCHINEN  
EMBUTIDORAS MANUALES DE ACERO INOXIDABLE  
РУЧНЫЕ НАПОЛНИТЕЛИ КОЛБАС ИЗ  
НЕРЖАВЕЮЩЕЙ

IT Struttura in acciaio inox - pistone in alluminio - **2 velocità**: una lenta per l'avanzamento del pistone, l'altra veloce di ritorno - in dotazione 3 imbutoi ø 8 mm - 16,5 mm - 23,5 mm.  
Optional: Serie imbutoi per insaccatrici, 3 pezzi.









EN Stainless steel structure - aluminium piston - **2 speeds**: a slow one for the piston advancement, a faster one to retract - supplied with 3 funnels ø 8 mm - 16,5 mm - 23,5 mm. Accessories: Funnels for sausage fillers, 3 pcs.

FR Corps en acier inox - piston en aluminium - **2 vitesses**: lente pour faire avancer le piston, rapide pour son retour - de série 3 entonnoirs ø 8 mm - 16,5 mm - 23,5 mm.  
Accessoires: Série d'entonnoirs pour poussoir à saucisse, 3 pièces.

DE Gehäuse aus Edelstahl - Aluminiumkolben - **2 Geschwindigkeiten**, langsam für das Vorrücken des Kolbens, schnell für die Rückkehr - Ausstattung: 3 Trichter mit ø 8 mm - 16,5 mm - 23,5 mm.  
Zubehör: Einfülltrichter-Satz, 3 Stück.

ES Estructura de acero inoxidable - pistón de aluminio - **2 velocidades**, una lenta para el avance del pistón y otra veloz para su vuelta - en la dotación 3 embudos de ø 8 mm - 16,5 mm - 23,5 mm.  
Accesorios: Serie de embudos para embutidoras, 3 unidades.

RU Корпус из нержавеющей стали - Алюминиевый поршень - **2 скорости**, медленное поступательное движение и быстрый возврат поршня - Оснащение: 3 воронки с ø 8 мм - 16,5 мм - 23,5 мм.  
Аксессуары: набор наполняющих воронок, 3 шт.

	LT7OR	LT7VE	LT14OR	LT14VE
	7 L ø 155 x 330(h) mm		14 L ø 196 x 485(h) mm	
	1200 x 400 x 400(h) mm	400 x 450 x 1050(h) mm	1550 x 450 x 450(h) mm	450 x 450 x 1400(h) mm
				
	18 Kg	26 Kg	27 Kg	36 Kg
	29 Kg	37 Kg	37 Kg	47 Kg
	800 x 350 x 480(h) mm		960 x 410 x 500(h) mm	
	0,134 m <sup>3</sup>		0,197 m <sup>3</sup>	



# F10-F13

New

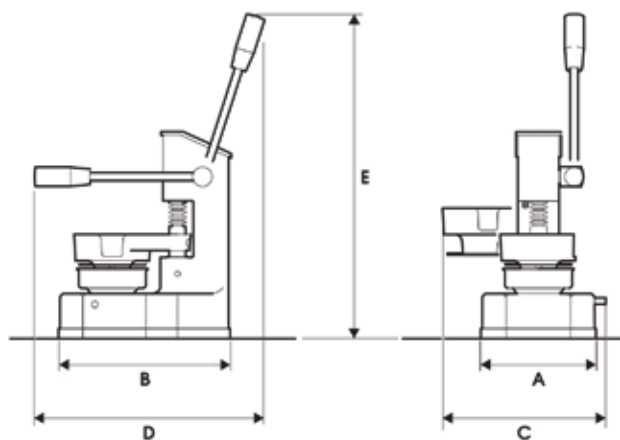

	∅ 100	∅ 130
A mm	175	175
B mm	260	260
C mm	250	275
D mm	370	420
E mm	500	530

Pressamburger

MANUAL HAMBURGER PRESS  
PRESSE-HAMBURGER MANUELLE  
MANUELLE HAMBURGERPRESSE  
FORMADORA DE HAMBURGUESAS MANUAL  
РУЧНОЙ ПРЕСС ДЛЯ ГАМБУРГЕРОВ

IT Struttura in alluminio anodizzato - parti a contatto con la carne in acciaio inox.  
**F10: hamburger ø 100 mm.**  
**F13: hamburger ø 130 mm.**







EN Anodised aluminium structure - parts in contact with meat made of stainless steel.  
**F10: hamburger ø 100 mm.**  
**F13: hamburger ø 130 mm.**



FR Corps en aluminium anodisé - pièces en contact avec la viande en acier inox.  
**F10: hamburger ø 100 mm.**  
**F13: hamburger ø 130 mm.**

DE Gehäuse aus Eloxaluminium - fleischberührende Teile aus Edelstahl.  
**F10: für Hamburger ø 100 mm.**  
**F13: für Hamburger ø 130 mm.**

ES Estructura de aluminio anodizado - partes en contacto con la carne de acero inoxidable.  
**F10: para hamburguesa ø 100 mm.**  
**F13: para hamburguesa ø 130 mm.**

RU Корпус из анодированного алюминия - детали механизма для перемешивания мяса из нержавеющей стали.  
**F10: Для гамбургеров ø 100 мм.**  
**F13: Para hamburguesa ø 130 мм.**

	F10	F13
		
	370 x 250 x 500(h) mm	420 x 275 x 530(h) mm
		
	5 Kg	5,5 Kg
	6 Kg	7 Kg
	280 x 210 x 340(h) mm	
	0,020 m <sup>3</sup>	

	ACCARTAF10	ACCARTAF30
	Confezione di cellophan da 1 Kg - 1 Kg cellophan sheets 1 Kg feuilles de cellophane - 1 Kg zellophan Blätter Envase de celofán de 1 Kg - Целлофановая упаковка 1 Kr	
	100 mm	130 mm





# Lavorazione Pasta

PASTA PROCESSING  
TRAVAIL DE LA PÂTE  
TEIGVERARBEITUNG  
ELABORACIÓN PASTA  
ПРИГОТОВЛЕНИЕ ТЕСТА



## IT

Tutti i macchinari di Fimar sono progettati e realizzati in Italia, non può quindi mancare un'ampia gamma di attrezzature per la lavorazione della pasta per la realizzazione di dolci, pane, pizza, piada e naturalmente pasta fresca.

Una lunga serie di impastatrici apre il capitolo: dalla più innovativa "Berta" fino alla linea di Impastatrici a Spirale, a Forcella e naturalmente le Planetarie, e ancora Macchine per la Pasta Fresca, Stendipizza e Sfogliatrici.

## EN

All Fimar machines are designed and manufactured in Italy, so a wide range of equipment for the processing of pasta for the production of cakes, bread, pizza, piadina and of course fresh pasta is a must.

A long series of kneading machines opens the chapter: from the most innovative "Berta" to the line of Spiral, Fork and, of course, Planetary kneaders. We complete our catalogue with the range of machines for fresh pasta, pizza stretchers and dough sheeters.

## FR

Toutes les machines Fimar sont conçues et fabriquées en Italie, on ne peut donc pas manquer une large gamme d'équipements pour le traitement des pâtes pour la production de gâteaux, pain, pizza, piadina et bien sûr des pâtes fraîches.

Une longue série de pétrisseuses ouvre le chapitre: de la plus innovante "Berta" à la gamme des pétrisseuses à Spirale, à fourche et, bien sûr, des pétrisseuses Planétaires. Nous complétons notre catalogue avec la gamme de machines pour pâtes fraîches, étendoirs à pizza et coupe-pâtes en feuilles.

## DE

Alle Fimar-Maschinen werden in Italien entwickelt und hergestellt, so dass Sie nicht auf eine breite Auswahl an Geräten für die Verarbeitung von Pasta für die Herstellung von Kuchen, Brot, Pizza, Piadina und natürlich frischen Pasta verzichten müssen.

Eine umfangreiche Serie von Knetmaschinen eröffnet nun das Kapitel: von der innovativsten "Berta" bis hin zur Spiral-, Gabel- und natürlich Planetenknetmaschinen. Wir vervollständigen unseren Katalog mit dem Sortiment an Maschinen für frische Pasta, Pizzastreckmaschinen und Teigausrollmaschinen.

## ES

Todas las máquinas de marca Fimar han sido diseñadas y realizadas en Italia. Por lo tanto, no puede faltar una amplia gama de aparatos para la elaboración de la pasta, para preparar dulces, pan, pizza y "piadina" y, por supuesto, pasta fresca.

Para empezar, una larga serie de amasadoras: de "Berta", la más innovadora, a la línea de amasadoras de espiral, de horquilla y, naturalmente, planetaria. Nuestro catálogo sigue con la gama de máquinas para la pasta fresca, extendedora de masa para la pizza y para pasta.

## RU

Все машины Fimar спроектированы и изготовлены в Италии, поэтому вы не можете пропустить широкий ассортимент оборудования для переработки макарон для производства тортов, хлеба, пиццы, пиадины и, конечно же, свежей пасты.

Длинная серия машин для замешивания открывает главу: от самых инновационных машин "Berta" до серии машин для замешивания спирали, вил и, конечно же, планетарных машин для замешивания. Мы дополняем наш каталог машинами для производства свежих макарон, носилок для пиццы и тестомолочна.

BERTA® 7  
BERTA® 15



BERTA7

**Berta**®  
L'IMPASTATRICE FACILE, VELOCE ED ESPERTA



Impastatrice "Berta"

"BERTA" KNEADER  
"BERTA" PETRIN  
"BERTA" TEIGKNETMASCHINE  
"BERTA" AMASADORA  
"BERTA" TECTOMEC



GUARDA IL VIDEO  
WATCH THE VIDEO

**IT Macchina ideale per impasti a bassa idratazione, ricchi di grassi** come: piada, taralli, grissini o pizza in teglia. Ottimi risultati anche per impasti all'uovo. L'impastatrice "Berta" grazie all'innovativo sistema di utensile a gancio riproduce il movimento della lavorazione a mano e non altera la temperatura dell'impasto migliorandone l'ossigenazione e la digeribilità; i tempi di lavorazione dell'impasto sono dimezzati rispetto alle tradizionali impastatrici. Struttura rivestita con vernice antigraffio - vasca, utensile e coperchio grigliato in acciaio inox AISI 304. Optional: 2° velocità solo su modelli trifase, timer meccanico e ruote.

**EN The ideal machine for low-hydration and high-fat doughs** such as piada, taralli, breadsticks, pizza in trays, also suitable for egg mixtures. "Berta" uses the innovative hook tool system, which reproduces the movement of manual kneading without altering the temperature of the dough, improving its oxygenation and digestibility. Dough processing times are halved compared to traditional kneading machines. Casing coated with scratch-proof paint - bowl, tool and grilled lid in stainless steel AISI 304. Optional: 2nd speed only on three-phase models, mechanical timer and wheels.

**FR Machine idéale pour les pâtes à faible hydratation et à forte teneur en matières grasses** telles que piada, taralli, grissins, pan pizza, elle peut également être utilisée pour les pâtes aux œufs. "Berta" utilise le système innovant d'outils à crochets qui reproduit le mouvement du travail manuel et n'altère pas la température de la pâte, améliorant ainsi l'oxygénation et la digestibilité. Le temps de travail de la pâte est réduit de moitié par rapport aux pétrins traditionnel. Corps recouvert de peinture anti-rayures - cuve, outil et couvercle à grille en acier inox AISI 304. En option: 2ème vitesse uniquement sur les modèles triphasés, minuterie mécanique et roues.

**DE Die ideale Maschine für feuchtigkeitsarme und fettreiche Teige** wie Piada, Taralli, Brotstangen, Pfannenzpizza, sie kann auch für Eierteige verwendet werden. "Berta" verwendet das innovative Hakenwerkzeugsystem, das die Bewegung der Handarbeit nachbildet, ohne die Temperatur des Teigs zu verändern, wodurch die Sauerstoffzufuhr und die Verdaulichkeit verbessert werden. Die Teigverarbeitungszeiten halbieren sich im Vergleich zu herkömmlichen Knetmaschinen. Gehäuse mit kratzfester Lackierung beschichtet - Behälter, Werkzeug und Deckel aus Edelstahl AISI 304. Optional: Zweite Geschwindigkeit nur bei Drehstrommodellen, mechanische Zeitschaltuhr und Rädern.

**ES Máquina ideal para masas de baja hidratación y alto contenido en grasa** como piada, taralli, palitos de pan, pizza en molde, también se puede utilizar para masas al huevo. "Berta" utiliza el innovador sistema de herramienta de gancho que reproduce el movimiento del trabajo manual sin alterar la temperatura de la masa, mejorando la oxigenación y la digestibilidad. Los tiempos de procesamiento de la masa se reducen a la mitad en comparación con las amasadoras tradicionales. Estructura recubierta de pintura antiarañazos - bol, útil y tapa en acero inoxidable AISI 304. Opcional: 2ª velocidad sólo en modelos trifásicos, temporizador mecánico y ruedas.

**RU Машина идеальна для приготовления теста с низким содержанием влаги, богатого жирами, например, для приготовления лепешек (пиада), сухек (таралли), хлебных палочек или пиццы на сковороде. Оптимальна также для приготовления яичного теста. Благодаря инновационной крюковой системе, тестомес "Berta" воспроизводит движения ручного замеса без изменения температуры теста, насыщая его кислородом и улучшая усвояемость. Время приготовления теста сокращается вдвое по сравнению с традиционными миксерами. Конструкция покрыта антицарапанной краской - бак, инструмент и крышка из нержавеющей стали AISI 304. Опционально: 2-я скорость только для трехфазных моделей, механический таймер и колеса.**

	<b>BERTA7</b>	<b>BERTA15</b>
	0,37 kW (1 Ph) 0,55/0,37 kW (only 3 Ph) 2 <sup>nd</sup> speed (optional)	0,55 kW (1 Ph - 3 Ph) 0,75/0,55 kW 2 <sup>nd</sup> speed (optional)
	400V/3N/50Hz	
	230V/1N/50Hz	
	7 Kg	15 Kg
	260 x 200 - 10 L	360 x 210 - 20 L
	35 rpm 35 - 70 rpm - 2 <sup>nd</sup> speed (optional)	28 rpm 28 - 56 rpm - 2 <sup>nd</sup> speed (optional)
	315 x 480 x 700(h) mm	410 x 580 x 755(h) mm
		
	39 Kg	51 Kg
	47,5 Kg	59,5 Kg
	460 x 700 x 860(h) mm	
	0,276 m³	

BERTA® 25  
BERTA® 35



BERTA25

**Berta**®  
L'IMPASTATRICE FACILE, VELOCE ED ESPERTA



Impastatrice "Berta"

"BERTA" KNEADER  
"BERTA" PETRIN  
"BERTA" TEIGKNETMASCHINE  
"BERTA" AMASADORA  
"BERTA" TECTOMEK



GUARDA IL VIDEO  
WATCH THE VIDEO

100

**fimar**

**IT Macchina ideale per impasti a bassa idratazione, ricchi di grassi** come: piada, taralli, grissini o pizza in teglia. Ottimi risultati anche per impasti all'uovo. L'impastatrice "Berta" grazie all'innovativo sistema di utensile a gancio riproduce il movimento della lavorazione a mano e non altera la temperatura dell'impasto migliorandone l'ossigenazione e la digeribilità; i tempi di lavorazione dell'impasto sono dimezzati rispetto alle tradizionali impastatrici. Struttura rivestita con vernice antigraffio - vasca, utensile e coperchio grigliato in acciaio inox AISI 304. Optional: 2° velocità solo su modelli trifase, timer meccanico e ruote.













**EN The ideal machine for low-hydration and high-fat doughs** such as piada, taralli, breadsticks, pizza in trays, also suitable for egg mixtures. "Berta" uses the innovative hook tool system, which reproduces the movement of manual kneading without altering the temperature of the dough, improving its oxygenation and digestibility. Dough processing times are halved compared to traditional kneading machines. Casing coated with scratch-proof paint - bowl, tool and grilled lid in stainless steel AISI 304. Optional: 2nd speed only on three-phase models, mechanical timer and wheels.

**FR Machine idéale pour les pâtes à faible hydratation et à forte teneur en matières grasses** telles que piada, taralli, gressins, pan pizza, elle peut également être utilisée pour les pâtes aux œufs. "Berta" utilise le système innovant d'outils à crochets qui reproduit le mouvement du travail manuel et n'altère pas la température de la pâte, améliorant ainsi l'oxygénation et la digestibilité. Le temps de travail de la pâte est réduit de moitié par rapport aux pétrins traditionnel. Corps recouvert de peinture anti-rayures - cuve, outil et couvercle à grille en acier inox AISI 304. En option: 2ème vitesse uniquement sur les modèles triphasés, minuterie mécanique et roues.

**DE Die ideale Maschine für feuchtigkeitsarme und fettreiche Teige** wie Piada, Taralli, Brotstangen, Pfannenzpizza, sie kann auch für Eierteige verwendet werden. "Berta" verwendet das innovative Hakenwerkzeugsystem, das die Bewegung der Handarbeit nachbildet, ohne die Temperatur des Teigs zu verändern, wodurch die Sauerstoffzufuhr und die Verdaulichkeit verbessert werden. Die Teigverarbeitungszeiten halbieren sich im Vergleich zu herkömmlichen Knetmaschinen. Gehäuse mit kratzfester Lackierung beschichtet - Behälter, Werkzeug und Deckel aus Edelstahl AISI 304. Optional: Zweite Geschwindigkeit nur bei Drehstrommodellen, mechanische Zeitschaltuhr und Rädern.

**ES Máquina ideal para masas de baja hidratación y alto contenido en grasa** como piada, taralli, palitos de pan, pizza en molde, también se puede utilizar para masas al huevo. "Berta" utiliza el innovador sistema de herramienta de gancho que reproduce el movimiento del trabajo manual sin alterar la temperatura de la masa, mejorando la oxigenación y la digestibilidad. Los tiempos de procesamiento de la masa se reducen a la mitad en comparación con las amasadoras tradicionales. Estructura recubierta de pintura antiarañazos - bol, útil y tapa en acero inoxidable AISI 304. Opcional: 2ª velocidad sólo en modelos trifásicos, temporizador mecánico y ruedas.

**RU Машина идеальна для приготовления теста с низким содержанием влаги, богатого жирами, например, для приготовления лепешек (пиада), сухек (таралли), хлебных палочек или пиццы на сковороде. Оптимальна также для приготовления яичного теста. Благодаря инновационной крюковой системе, тестомес "Berta" воспроизводит движения ручного замеса без изменения температуры теста, насыщая его кислородом и улучшая усвояемость. Время приготовления теста сокращается вдвое по сравнению с традиционными миксерами. Конструкция покрыта антицарапанной краской - бак, инструмент и крышка из нержавеющей стали AISI 304. Опционально: 2-я скорость только для трехфазных моделей, механический таймер и колеса**

	<b>BERTA25</b>	<b>BERTA35</b>
	0,9 kW (1 PH) - 0,75 kW (3 PH) 0,75/1,1 kW 2 <sup>nd</sup> speed (optional)	1,1 kW (1 PH) - 0,75 kW (3 PH) 0,75/1,1 kW 2 <sup>nd</sup> speed (optional)
	400V/3N/50Hz	
	230V/1N/50Hz	-
	25 Kg	35 Kg
	400 x 260 - 32 L	450 x 260 - 42 L
	23 rpm 23 - 46 rpm - 2 <sup>nd</sup> speed (optional)	
	470 x 625 x 805(h) mm	520 x 675 x 805(h) mm
		
	61,5 Kg	68,5 Kg
	72 Kg	79 Kg
	550 x 850 x 1060(h) mm	
	0,495 m³	

# FF30N



FF30NV

Impastatrice a forcella

FORK KNEADER  
PETRISSEUSE À FOURCHE  
GABELKNETER  
AMASADORA DE HORQUILLA  
ВИЛОЧНЫЙ ТЕСТОМЕС

IT Impastatrice con utensile a forcella che consente la lavorazione degli impasti più duri permettendo un'ottima ossigenazione ed evitando il riscaldamento dell'impasto. Carcassa in acciaio verniciato - vasca, forcella e coperchio in acciaio inox AISI 304 - timer meccanico. La protezione della vasca per metà grigliata permette l'aggiunta degli ingredienti anche in lavorazione. Accessori: seconda velocità, carrello 10(h) cm o cavalletto 40(h) cm.











EN Kneader with fork tool that allows the processing of the hardest doughs allowing an excellent oxygenation and avoiding the heating of the dough. Painted steel casing - AISI 304 stainless steel bowl, fork and lid - mechanical timer. The protection of the half grilled bowl allows the addition of ingredients also during processing. Accessories: second speed, trolley 10(h) cm or stand 40(h) cm.

FR Pétrisseur à fourche qui permet la transformation des pâtes les plus dures permettant une excellente oxygénation et évitant le chauffage de la pâte. Corps en acier verni - cuve, fourche et couvercle en acier inox AISI 304 - minuterie mécanique. La protection de la cuve à moitié grillé, permet l'ajout d'ingrédients même pendant le mélange. Accessoires: régulateur de vitesse, chariot 10(h) cm ou support 40(h) cm.

DE Teigknetmaschine mit Gabelwerkzeug. Die Drehung des Gabelwerkzeugs ermöglicht die Verarbeitung selbst härtester Teige, was zu einer hervorragenden Sauerstoffversorgung führt und die Erwärmung des Teigs verhindert. Gehäuse aus lackiertem Stahl - Schüssel, Gabel und Deckel aus Edelstahl AISI 304 - mechanischer Zeitregler. Der Schutz des Schüssels, halb gegrillt, erlaubt die Zugabe der Zutaten auch während der Verarbeitung. Zubehör: Geschwindigkeitsregler, Wagen 10(h) cm oder Stützfuß 40(h) cm.

ES Máquina ideal para pizzerías, pastelerías y panaderías. La rotación de la herramienta con horquilla permite la elaboración también de las masas más duras con una excelente oxigenación, evitando que se caliente. Carcasa de acero pintado - bol, horquilla y tapa de acero inoxidable - temporizador mecánico. La protección del bol - con una red en una mitad- permite añadir ingredientes también durante la elaboración. Accesorios: mando de regulación de la velocidad, carrito 10(h) cm o trípode 40(h) cm.

RU Тестомес с вилочной мешалкой. Вращающаяся мешалка в форме вилки позволяет приготовить даже самое жесткое тесто, обеспечивая отличную оксигенацию и предотвращая нагрев теста. Корпус из окрашенной стали - дежа, вилка и крышка из нержавеющей стали AISI 304 - механический таймер. Защита дежи, наполовину закрытая решеткой, позволяет добавлять ингредиенты даже во время приготовления теста. Аксессуары: регулятор скорости, тележка высотой 10 см или опорная ножка высотой 40 см.

FF30N	
	0,75 kW (1 HP) 0,75/1,1 kW (1/1,5 HP) - 2 <sup>nd</sup> speed (optional)
	400V/3/50Hz
	230V/1N/50Hz
	Meccanico - Mechanical - Механический
	90 Kg/h
	30 Kg
	35 L (ø 530 x 220(h) mm)
	24 rpm 24 - 35 rpm - 2 <sup>nd</sup> speed (optional)
	1000 x 650 x 610(h) mm
	
	140 Kg
	152 Kg
	1160 x 770 x 780(h) mm
	0,696 m³



# Optional

impastatrice a forcella

ACCESSORIES  
ACCESSOIRES  
ZUBEHÖR  
ACCESORIOS  
AKCECCYAPЫ



Cavalletto - Stand - Support - Stützfuß - Trípode - Подставка

	<b>CAV40FORFF30N0</b>
	640 x 590 x 400(h) mm
	6,5 Kg
	8 Kg
	700 x 410 x 170(h) mm
	0,487 m <sup>3</sup>

Carrello - Trolley - Chariot - Wagen - Carrito - Тележка

	<b>CAR10FORFF30N0</b>
	480 x 580 x 100(h) mm
	8,5 Kg
	10 Kg
	630 x 550 x 120(h) mm
	0,396 m <sup>3</sup>



12SR  
18SR

New



18SR



12SR

OPTIONAL  
TIMER DIGITALE  
DIGITAL TIMER

Impastatrice a spirale  
con testa sollevabile e vasca estraibile

SPIRAL KNEADER  
PETRIN A SPIRAL  
SPIRALTEIGKNETMASCHINE  
AMASADORA DE ESPIRAL  
СПИРАЛЬНЫЙ ТЕСТОМЕС

**IT Impastatrice a spirale con testa sollevabile e vasca estraibile.** Macchina per realizzare diversi tipi di impasto, indicata soprattutto per impasti teneri come pane, pizza e piada. Struttura rivestita con vernice antigraffio - parti a contatto con gli alimenti quali vasca, spirale ed asta spacca pasta sono in acciaio inox - microinterruttore di sicurezza su coperchio vasca - coperchio in policarbonato fumè di serie. Vari optional a richiesta, tra cui coperchio grigliato in acciaio inox AISI 304.

**EN Spiral kneader with liftable head and removable bowl.** Machine for the processing of different types of dough, especially suitable for soft doughs such as bread, pizza and piadina. Structure coated with scratch-proof paint - parts in contact with food such as bowl, spiral and dough splitting rod are made of stainless steel - safety microswitch on bowl lid - smoked polycarbonate lid as standard. Different options on request, including AISI 304 stainless steel grilled cover.

**FR Pétrin à spirale avec tête relevable et cuve amovible.** Machine pour le pétrissage de différents types de pâte, particulièrement adaptée aux pâtes tendres telles que le pain, la pizza et la piadina. Structure recouverte de peinture anti-rayures - les parties en contact avec les aliments telles que la cuve, la spirale et la brise-pâte sont en acier inox - microrupteur de sécurité sur le couvercle de la cuve - couvercle en polycarbonate fumé de série. Différentes options sur demande, incluant couvercle grillé en acier inox AISI 304.

**DE Spiraleteigknetmaschine mit anhebbarer Kopf und abnehmbarer Schüssel.** Maschine zur Zubereitung verschiedener Teigarten, besonders geeignet für weiche Teige wie Brot, Pizza und Piadina. Gehäuse mit kratzfester Lackierung beschichtet - Teile, die mit Lebensmitteln in Berührung kommen, wie Schüssel, Spirale und Teigknetstab, sind aus Edelstahl gefertigt. Sicherheitsmikroschalter am Behälterdeckel - Serienmäßig mit Rauchgrau Polycarbonat-Deckel. Auf Anfrage verschiedene Ausstattungen, wie z. B. Gitterdeckel aus Edelstahl AISI 304.

**ES Amasadora de espiral con cabeza retráctil y bol extraíble.** Máquina para realizar diferentes tipos de masas, se aconseja especialmente para masas como pan, pizza y tortillas. Estructura recubierta con pintura anti-arañazos - partes en contacto con los alimentos (bol, espiral y barra para romper la masa) de acero inoxidable - microinterruptor de seguridad en la tapa del bol - tapa de policarbonato fumé de serie. Se pueden pedir unos extras o accesorios como la tapa con red de acero inoxidable AISI 304.

**RU Спиральный тестомес с подъемной траверсой и съёмной чашей.** Машина для приготовления различных видов теста, особенно подходит для мягкого теста, такого как хлеб, пицца и пиадина. Покрытие устойчивой к царапинам краской. Детали, контактирующие с пищевыми продуктами, такие как дежа, спирали и мешалка, изготовлены из нержавеющей стали. Предохранительный микровыключатель на крышке, в стандартной комплектации крышка из поликарбоната дымчато-серого цвета. По запросу, различное оборудование, например, крышка решетки из нержавеющей стали AISI 304.

	12SR	18SR
	0,75 kW (1 HP) 0,75/0,55 kW (1/0,75 HP) - 2 <sup>nd</sup> speed (optional)	
	230-400V/3N/50Hz	
	230V/1N/50Hz	
	36 Kg/h	54 Kg/h
	12 Kg	18 Kg
	16 L (ø 320 x 210(h) mm)	22 L (ø 360 x 210(h) mm)
	90 rpm 90 - 180 rpm - 2 <sup>nd</sup> speed (optional)	
	632 x 320 x 750÷932(h) mm	653 x 380 x 750÷951(h) mm
		
	65 Kg	67 Kg
	75 Kg	77 Kg
	700 x 460 x 890(h) mm	
	0,250 m³	

25SR  
38SR

New



38SR

OPTIONAL  
TIMER DIGITALE  
DIGITAL TIMER

Impastatrice a spirale  
con testa sollevabile e vasca estraibile

SPIRAL KNEADER  
PETRIN A SPIRAL  
SPIRALTEIGKNETMASCHINE  
AMASADORA DE ESPIRAL  
СПИРАЛЬНЫЙ ТЕСТОМЕС

**IT Impastatrice a spirale con testa sollevabile e vasca estraibile.** Macchina per realizzare diversi tipi di impasto, indicata soprattutto per impasti teneri come pane, pizza e piada. Struttura rivestita con vernice antigraffio - parti a contatto con gli alimenti quali vasca, spirale ed asta spacca pasta sono in acciaio inox - microinterruttore di sicurezza su coperchio vasca - coperchio in policarbonato fumè di serie. Vari optional a richiesta, tra cui coperchio grigliato in acciaio inox AISI 304.

**EN Spiral kneader with liftable head and removable bowl.** Machine for the processing of different types of dough, especially suitable for soft doughs such as bread, pizza and piadina. Structure coated with scratch-proof paint - parts in contact with food such as bowl, spiral and dough splitting rod are made of stainless steel - safety microswitch on bowl lid - smoked polycarbonate lid as standard. Different options on request, including AISI 304 stainless steel grilled cover.

**FR Pétrin à spirale avec tête relevable et cuve amovible.** Machine pour le pétrissage de différents types de pâte, particulièrement adaptée aux pâtes tendres telles que le pain, la pizza et la piadina. Structure recouverte de peinture anti-rayures - les parties en contact avec les aliments telles que la cuve, la spirale et la brise-pâte sont en acier inox - microrupteur de sécurité sur le couvercle de la cuve - couvercle en polycarbonate fumé de série. Différentes options sur demande, incluant couvercle grillé en acier inox AISI 304.

**DE Spiralteigknetmaschine mit anhebbarem Kopf und abnehmbarer Schüssel.** Maschine zur Zubereitung verschiedener Teigarten, besonders geeignet für weiche Teige wie Brot, Pizza und Piadina. Struktur mit kratzfester Lackierung beschichtet - Teile, die mit Lebensmitteln in Berührung kommen, wie Schüssel, Spirale und Teigknetstab, sind aus Edelstahl gefertigt. Sicherheitsmikroschalter am Behälterdeckel - Serienmäßig mit Rauchgrau Polycarbonat-Deckel.

**ES Amasadora de espiral con cabeza retráctil y bol extraíble.** Máquina para realizar diferentes tipos de masas, se aconseja especialmente para masas como pan, pizza y tortillas. Estructura recubierta con pintura anti-arañazos - partes en contacto con los alimentos (bol, espiral y barra para romper la masa) de acero inoxidable - microinterruptor de seguridad en la tapa del bol - tapa de policarbonato fumé de serie. Se pueden pedir unos extras o accesorios como la tapa con red de acero inoxidable AISI 304.

**RU Спиральный тестомес с подъемной траверсой и съёмной чашей.** Машина для приготовления различных видов теста, особенно подходит для мягкого теста, такого как хлеб, пицца и пиадина. Покрытие устойчивой к царапинам краской. Детали, контактирующие с пищевыми продуктами, такие как дежа, спирали и мешалка, изготовлены из нержавеющей стали. Предохранительный микровыключатель на крышке, в стандартной комплектации крышка из поликарбоната дымчато-серого цвета.

	25SR	38SR
	1,5 kW (2 HP) 1,5/1,1 kW (2/1,5 HP) - 2 <sup>nd</sup> speed (optional)	
	230-400V/3N/50Hz	
	230V/1N/50Hz	
	75 Kg/h	114 Kg/h
	25 Kg	38 Kg
	32 L (ø 400 x 260(h) mm)	42 L (ø 450 x 260(h) mm)
	90 rpm 90 - 180 rpm - 2 <sup>nd</sup> speed (optional)	
	762 x 420 x 864+1123(h) mm	800 x 474 x 866+1148(h) mm
		
	102 Kg	108 Kg
	112 Kg	118 Kg
	850 x 550 x 1055(h) mm	
	0,490 m³	

# 50SR

New



Impastatrice a spirale  
con testa sollevabile e vasca estraibile

SPIRAL KNEADER  
PETRIN A SPIRAL  
SPIRALTEIGKNETMASCHINE  
AMASADORA DE ESPIRAL  
СПИРАЛЬНЫЙ ТЕСТОМЕС

**IT Impastatrice a spirale con testa sollevabile e vasca estraibile.** Macchina per realizzare diversi tipi di impasto, indicata soprattutto per impasti teneri come pane, pizza e piada. Struttura rivestita con vernice antigraffio - parti a contatto con gli alimenti quali vasca, spirale ed asta spacca pasta sono in acciaio inox - microinterruttore di sicurezza su coperchio vasca - disponibile solo con coperchio grigliato in acciaio inox AISI 304.













**EN Spiral kneader with liftable head and removable bowl.** Machine for the processing of different types of dough, especially suitable for soft doughs such as bread, pizza and piadina. Structure coated with scratch-proof paint - parts in contact with food such as bowl, spiral and dough splitting rod are made of stainless steel - safety microswitch on bowl lid. Only available with AISI 304 stainless steel grilled cover.

**FR Pétrin à spirale avec tête relevable et cuve amovible.** Machine pour le pétrissage de différents types de pâte, particulièrement adaptée aux pâtes tendres telles que le pain, la pizza et la piadina. Structure recouverte de peinture anti-rayures - les parties en contact avec les aliments telles que la cuve, la spirale et la brise-pâte sont en acier inox - microrupteur de sécurité sur le couvercle de la cuve - couvercle en polycarbonate fumé de série. Différentes options sur demande, incluant couvercle grillé en acier inox AISI 304.

**DE Spiralteigknetmaschine mit anhebbarer Kopf und abnehmbarer Schüssel.** Maschine zur Zubereitung verschiedener Teigarten, besonders geeignet für weiche Teige wie Brot, Pizza und Piadina. Struktur mit kratzfester Lackierung beschichtet - Teile, die mit Lebensmitteln in Berührung kommen, wie Schüssel, Spirale und Teigknetstab, sind aus Edelstahl gefertigt. Sicherheitsmikroschalter am Behälterdeckel. Nur mit Gitterabdeckung aus Edelstahl AISI 304 erhältlich.

**ES Amasadora de espiral con cabeza retráctil y bol extraíble.** Máquina para realizar diferentes tipos de masas, se aconseja especialmente para masas como pan, pizza y tortillas. Estructura recubierta con pintura anti-arañazos - partes en contacto con los alimentos (bol, espiral y barra para romper la masa) de acero inoxidable - microinterruptor de seguridad en la tapa del bol. Solamente con tapa con red de acero inoxidable AISI 304.

**RU Спиральный тестомес с подъемной траверсой и съёмной чашей.** Машина для приготовления различных видов теста, особенно подходит для мягкого теста, такого как хлеб, пицца и пиадина. Покрытие устойчивой к царапинам краской. Детали, контактирующие с пищевыми продуктами, такие как дежа, спирали и мешалка, изготовлены из нержавеющей стали. Предохранительный микровыключатель на крышке. Поставляется только с крышкой из нержавеющей стали AISI 304.

	<b>50SR</b>
	2,2 kW (3 HP) 3,5/2,5 kW (4,7/3,3 HP) - 2 <sup>nd</sup> speed (optional)
	230-400V/3N/50Hz
	150 Kg/h
	50 Kg
	62 L (ø 500 x 310(h) mm)
	80 rpm 80 - 160 rpm - 2 <sup>nd</sup> speed (optional)
	927 x 520 x 1074÷1393(h) mm
	
	182 Kg
	192 Kg
	1055 x 600 x 1276(h) mm
	0,803 m <sup>3</sup>

12SL  
18SL

New



12SL

# Impastatrice a spirale

con testa sollevabile e vasca fissa

SPIRAL KNEADER  
PETRIN A SPIRAL  
SPIRALTEIGKNETMASCHINE  
AMASADORA DE ESPIRAL  
СПИРАЛЬНЫЙ ТЕСТОМЕС



**IT Impastatrice a spirale con testa sollevabile e vasca fissa.** Macchina per realizzare diversi tipi di impasto, indicata soprattutto per impasti teneri come pane, pizza e piada. Struttura rivestita con vernice antigraffio - parti a contatto con gli alimenti quali vasca, spirale ed asta spacca pasta sono in acciaio inox - microinterruttore di sicurezza su coperchio vasca - coperchio in policarbonato fumè di serie. Vari optional a richiesta, tra cui coperchio grigliato in acciaio inox AISI 304.

**EN Spiral kneader with liftable head and fixed bowl.** Machine for the processing of different types of dough, especially suitable for soft doughs such as bread, pizza and piadina. Structure coated with scratch-proof paint - parts in contact with food such as bowl, spiral and dough splitting rod are made of stainless steel - safety microswitch on bowl lid - smoked polycarbonate lid as standard. Different options on request, including AISI 304 stainless steel grilled cover.

**FR Pétrin à spirale avec tête relevable et cuve fixe.** Machine pour le pétrissage de différents types de pâte, particulièrement adaptée aux pâtes tendres telles que le pain, la pizza et la piadina. Structure recouverte de peinture anti-rayures - les parties en contact avec les aliments telles que la cuve, la spirale et la brise-pâte sont en acier inox - microrupteur de sécurité sur le couvercle de la cuve - couvercle en polycarbonate fumé de série. Différentes options sur demande, incluant couvercle grillé en acier inox AISI 304.

**DE Spiralteigknetmaschine mit anhebbarer Kopf und stationärer Schüssel.** Maschine zur Zubereitung verschiedener Teigarten, besonders geeignet für weiche Teige wie Brot, Pizza und Piadina. Gehäuse Struktur mit kratzfester Lackierung beschichtet - Teile, die mit Lebensmitteln in Berührung kommen, wie Schüssel, Spirale und Teigknetstab, sind aus Edelstahl gefertigt. Sicherheitsmikroschalter am Behälterdeckel - Serienmäßig mit Rauchgrau Polycarbonat-Deckel.

**ES Amasadora de espiral con cabeza retráctil y bol fija.** Máquina para realizar diferentes tipos de masas, se aconseja especialmente para masas como pan, pizza y tortillas. Estructura recubierta con pintura anti-arañazos - partes en contacto con los alimentos (bol, espiral y barra para romper la masa) de acero inoxidable - microinterruptor de seguridad en la tapa del bol - tapa de policarbonato fumé de serie. Se pueden pedir unos extras o accesorios como la tapa con red de acero inoxidable AISI 304.

**RU Спиральный тестомес с подъемной траверсой и съёмной чашей.** Машина для приготовления различных видов теста, особенно подходит для мягкого теста, такого как хлеб, пицца и пиадина. Покрытие устойчивой к царапинам краской. Детали, контактирующие с пищевыми продуктами, такие как дежа, спирали и мешалка, изготовлены из нержавеющей стали. Предохранительный микровыключатель на крышке, в стандартной комплектации крышка из поликарбоната дымчато-серого цвета. Различные опции по запросу, в том числе крышка решетки из нержавеющей стали AISI 304.

	12SL	18SL
		
	0,75 kW (1 HP) 0,75/0,55 kW (1/0,75 HP) - 2 <sup>nd</sup> speed (optional)	
	230-400V/3N/50Hz	
	230V/1N/50Hz	
	36 Kg/h	54 Kg/h
	12 Kg	18 Kg
	16 L (ø 320 x 210(h) mm)	22 L (ø 360 x 210(h) mm)
	90 rpm 90 - 180 rpm - 2 <sup>nd</sup> speed (optional)	
	632 x 320 x 750÷932(h) mm	653 x 380 x 750÷951(h) mm
		
	62 Kg	64 Kg
	72 Kg	74 Kg
	700 x 460 x 890(h) mm	
	0,250 m³	

25SL  
38SL

New



25SL

# Impastatrice a spirale

con testa sollevabile e vasca fissa

SPIRAL KNEADER  
PETRIN A SPIRAL  
SPIRALTEIGKNETMASCHINE  
AMASADORA DE ESPIRAL  
СПИРАЛЬНЫЙ ТЕСТОМЕС

**IT Impastatrice a spirale con testa sollevabile e vasca fissa.** Macchina per realizzare diversi tipi di impasto, indicata soprattutto per impasti teneri come pane, pizza e piada. Struttura rivestita con vernice antigraffio - parti a contatto con gli alimenti quali vasca, spirale ed asta spacca pasta sono in acciaio inox - microinterruttore di sicurezza su coperchio vasca - coperchio in policarbonato fumè di serie. Vari optional a richiesta, tra cui coperchio grigliato in acciaio inox AISI 304.

**EN Spiral kneader with liftable head and fixed bowl.** Machine for the processing of different types of dough, especially suitable for soft doughs such as bread, pizza and piadina. Structure coated with scratch-proof paint - parts in contact with food such as bowl, spiral and dough splitting rod are made of stainless steel - safety microswitch on bowl lid - smoked polycarbonate lid as standard. Different options on request, including AISI 304 stainless steel grilled cover.

**FR Pétrin à spirale avec tête relevable et cuve fixe.** Machine pour le pétrissage de différents types de pâte, particulièrement adaptée aux pâtes tendres telles que le pain, la pizza et la piadina. Structure recouverte de peinture anti-rayures - les parties en contact avec les aliments telles que la cuve, la spirale et la brise-pâte sont en acier inox - microrupteur de sécurité sur le couvercle de la cuve - couvercle en polycarbonate fumé de série. Différentes options sur demande, incluant couvercle grillé en acier inox AISI 304.

**DE Spiralteignetmaschine mit anhebberem Kopf und stationärer Schüssel.** Maschine zur Zubereitung verschiedener Teigarten, besonders geeignet für weiche Teige wie Brot, Pizza und Piadina. Struktur mit kratzfester Lackierung beschichtet - Teile, die mit Lebensmitteln in Berührung kommen, wie Schüssel, Spirale und Teignetstab, sind aus Edelstahl gefertigt. Sicherheitsmikroschalter am Behälterdeckel - Serienmäßig mit Rauchgrau Polycarbonat-Deckel. Auf Anfrage sind verschiedene Zubehörteile erhältlich, einschließlich der Gitterabdeckung aus Edelstahl AISI 304.

**ES Amasadora de espiral con cabeza retráctil y bol fija.** Máquina para realizar diferentes tipos de masas, se aconseja especialmente para masas como pan, pizza y tortillas. Estructura recubierta con pintura anti-arañazos - partes en contacto con los alimentos (bol, espiral y barra para romper la masa) de acero inoxidable - microinterruptor de seguridad en la tapa del bol - tapa de policarbonato fumé de serie. Se pueden pedir unos extras o accesorios como la tapa con red de acero inoxidable AISI 304.

**RU Спиральный тестомес со съёмной траверсой и стационарной дежой.** Машина для приготовления различных видов теста, особенно подходит для мягкого теста, такого как хлеб, пицца и пиадина. Покрытие устойчивой к царапинам краской. Детали, контактирующие с пищевыми продуктами, такие как дежа, спирали и мешалка, изготовлены из нержавеющей стали. Предохранительный микровыключатель на крышке, в стандартной комплектации крышка из поликарбоната дымчато-серого цвета. Дополнительное оборудование, например, решетчатая крышка из нержавеющей стали AISI 304, по запросу.

	25SL	38SL
		
	1,5 kW (2 HP) 1,5/1,1 kW (2/1,5 HP) - 2 <sup>nd</sup> speed (optional)	
	230-400V/3N/50Hz	
	230V/1N/50Hz	
	75 Kg/h	114 Kg/h
	25 Kg	38 Kg
	32 L (ø 400 x 260(h) mm)	42 L (ø 450 x 260(h) mm)
	90 rpm 90 - 180 rpm - 2 <sup>nd</sup> speed (optional)	
	762 x 420 x 864÷1123(h) mm	800 x 474 x 866÷1148(h) mm
		
	94 Kg	102 Kg
	104 Kg	112 Kg
	850 x 550 x 1055(h) mm	
	0,490 m³	

# 50SL

New



Impastatrice a spirale  
con testa sollevabile e vasca fissa

SPIRAL KNEADER  
PETRIN A SPIRAL  
SPIRALTEIGKNETMASCHINE  
AMASADORA DE ESPIRAL  
СПИРАЛЬНЫЙ ТЕСТОМЕС

**IT Impastatrice a spirale con testa sollevabile e vasca fissa.** Macchina per realizzare diversi tipi di impasto, indicata soprattutto per impasti teneri come pane, pizza e piada. Struttura rivestita con vernice antigraffio - parti a contatto con gli alimenti quali vasca, spirale ed asta spacca pasta sono in acciaio inox - microinterruttore di sicurezza su coperchio vasca - disponibile solo con coperchio grigliato in acciaio inox AISI 304.













**EN Spiral kneader with liftable head and fixed bowl.** Machine for the processing of different types of dough, especially suitable for soft doughs such as bread, pizza and piadina. Structure coated with scratch-proof paint - parts in contact with food such as bowl, spiral and dough splitting rod are made of stainless steel - safety microswitch on bowl lid. Only available with AISI 304 stainless steel grilled cover.

**FR Pétrin à spirale avec tête relevable et cuve fixe.** Machine pour le pétrissage de différents types de pâte, particulièrement adaptée aux pâtes tendres telles que le pain, la pizza et la piadina. Structure recouverte de peinture anti-rayures - les parties en contact avec les aliments telles que la cuve, la spirale et la brise-pâte sont en acier inox - microrupteur de sécurité sur le couvercle de la cuve - Uniquement disponible avec couvercle grillé en acier inox AISI 304.

**DE Spiralteigknetmaschine mit anhebbaarem Kopf und stationärer Schüssel.** Maschine zur Zubereitung verschiedener Teigarten, besonders geeignet für weiche Teige wie Brot, Pizza und Piadina. Struktur mit kratzfester Lackierung beschichtet - Teile, die mit Lebensmitteln in Berührung kommen, wie Schüssel, Spirale und Teigknetstab, sind aus Edelstahl gefertigt. Sicherheitsmikroschalter am Behälterdeckel - nur mit Gitterabdeckung aus Edelstahl AISI 304 erhältlich.

**ES Amasadora de espiral con cabeza retráctil y bol fija.** Máquina para realizar diferentes tipos de masas, se aconseja especialmente para masas como pan, pizza y tortillas. Estructura recubierta con pintura anti-arañazos - partes en contacto con los alimentos (bol, espiral y barra para romper la masa) de acero inoxidable - microinterrupor de seguridad en la tapa del bol. Solamente con tapa con red de acero inoxidable AISI 304.

**RU Спиральный тестомес со съёмной траверсой и стационарной дежой.** Машина для приготовления различных видов теста, особенно подходит для мягкого теста, такого как хлеб, пицца и пиадина. Покрытие устойчивой к царапинам краской. Детали, контактирующие с пищевыми продуктами, такие как дежа, спирали и мешалка, изготовлены из нержавеющей стали. Предохранительный микровыключатель на крышке. Поставляется только с крышкой из нержавеющей стали AISI 304.

	<b>50SL</b>
	2,2 kW (3 HP) 3,5/2,5 kW (4,7/3,3 HP) - 2 <sup>nd</sup> speed (optional)
	230-400V/3N/50Hz
	150 Kg/h
	50 Kg
	62 L (ø 500 x 310(h) mm)
	80 rpm 80 - 160 rpm - 2 <sup>nd</sup> speed (optional)
	927 x 520 x 1074÷1393(h) mm
	
	179 Kg
	189 Kg
	1055 x 600 x 1276(h) mm
	0,803 m <sup>3</sup>

# 7SB

New



IMMAGINE INDICATIVA /  
INDICATIVE IMAGE

## Impastatrice a spirale con testa fissa

SPIRAL KNEADER  
PETRIN A SPIRAL  
SPIRALTEIGKNETMASCHINE  
AMASADORA DE ESPIRAL  
СПИРАЛЬНЫЙ ТЕСТОМЕС

**IT Impastatrice a spirale con testa fissa.** Macchina per realizzare diversi tipi di impasto, indicata soprattutto per impasti teneri come pane, pizza e piada. Struttura rivestita con vernice antigraffio - parti a contatto con gli alimenti quali vasca, spirale ed asta spacca pasta in acciaio inox - microinterruttore di sicurezza su coperchio vasca - disponibile solo con coperchio grigliato in acciaio inox AISI 304.















**EN Spiral kneader with fixed head.** Machine for the processing of different types of dough, especially suitable for soft doughs such as bread, pizza and piadina. Structure coated with scratch-proof paint - parts in contact with food such as bowl, spiral and dough splitting rod are made of stainless steel - safety microswitch on bowl lid. Only available with AISI 304 stainless steel grilled cover.

**FR Pétrin à spirale avec tête fixe.** Machine pour le pétrissage de différents types de pâte, particulièrement adaptée aux pâtes tendres telles que le pain, la pizza et la piadina. Structure recouverte de peinture anti-rayures - les parties en contact avec les aliments telles que la cuve, la spirale et la brise-pâte sont en acier inox - microrupteur de sécurité sur le couvercle de la cuve. Uniquement disponible avec couvercle grillé en acier inox AISI 304.

**DE Spiralteigknetmaschine mit festem Kopf.** Maschine zur Zubereitung verschiedener Teigarten, besonders geeignet für weiche Teige wie Brot, Pizza und Piadina. Struktur mit kratzfester Lackierung beschichtet - Teile, die mit Lebensmitteln in Berührung kommen, wie Schüssel, Spirale und Teigknetstab, sind aus Edelstahl gefertigt. Sicherheitsmikroschalter am Behälterdeckel - nur mit Gitterabdeckung aus Edelstahl AISI 304 erhältlich.

**ES Amasadora de espiral con cabeza fija.** Máquina para realizar diferentes tipos de masas, se aconseja especialmente para masas como pan, pizza y tortillas. Estructura recubierta con pintura anti-arañazos - partes en contacto con los alimentos (bol, espiral y barra para romper la masa) de acero inoxidable - microinterrupor de seguridad en la tapa del bol. Solamente con tapa con red de acero inoxidable AISI 304.

**RU Спиральный тестомес с неподвижной траверсой.** Машина для приготовления различных видов теста, особенно подходит для мягкого теста, такого как хлеб, пицца и пиадина. Покрытие устойчивой к царапинам краской. Детали, контактирующие с пищевыми продуктами, такие как дежа, спирали и мешалка, изготовлены из нержавеющей стали. Предохранительный микровыключатель на крышке. Поставляется только с крышкой из нержавеющей стали AISI 304.

	<b>7SB</b>
	0,37 kW (0,5 HP)
	230-400V/3N/50Hz
	230V/1N/50Hz
	21 Kg/h
	7 Kg
	10 L (ø 260 x 200(h) mm)
	90 rpm
	540 x 279 x 620÷841(h) mm
	
	40 Kg
	50 Kg
	700 x 460 x 890(h) mm
	0,290 m³

12SB  
18SB

New



12SB

OPTIONAL  
TIMER MECCANICO  
MECHANICAL TIMER



12SB

Impastatrice a spirale  
con testa fissa

SPIRAL KNEADER  
PETRIN A SPIRAL  
SPIRALTEIGKNETMASCHINE  
AMASADORA DE ESPIRAL  
СПИРАЛЬНЫЙ ТЕСТОМЕС



**IT Impastatrice a spirale con testa fissa.** Macchina per realizzare diversi tipi di impasto, indicata soprattutto per impasti teneri come pane, pizza e piada. Struttura rivestita con vernice antigraffio - parti a contatto con gli alimenti quali vasca, spirale ed asta spacca pasta sono in acciaio inox - microinterruttore di sicurezza su coperchio vasca - coperchio in policarbonato fumè di serie. Vari optional a richiesta, tra cui coperchio grigliato in acciaio inox AISI 304.

**EN Spiral kneader with fixed head.** Machine for the processing of different types of dough, especially suitable for soft doughs such as bread, pizza and piadina. Structure coated with scratch-proof paint - parts in contact with food such as bowl, spiral and dough splitting rod are made of stainless steel - safety microswitch on bowl lid - smoked polycarbonate lid as standard. Different options on request, including AISI 304 stainless steel grilled cover.

**FR Pétrin à spirale avec tête fixe.** Machine pour le pétrissage de différents types de pâte, particulièrement adaptée aux pâtes tendres telles que le pain, la pizza et la piadina. Structure recouverte de peinture anti-rayures - les parties en contact avec les aliments telles que la cuve, la spirale et la brise-pâte sont en acier inox - microrupteur de sécurité sur le couvercle de la cuve - couvercle en polycarbonate fumé de série. Différentes options sur demande, incluant couvercle grillé en acier inox AISI 304.

**DE Spiralteigknetmaschine mit festem Kopf.** Maschine zur Zubereitung verschiedener Teigarten, besonders geeignet für weiche Teige wie Brot, Pizza und Piadina. Struktur mit kratzfester Lackierung beschichtet - Teile, die mit Lebensmitteln in Berührung kommen, wie Schüssel, Spirale und Teigknetstab, sind aus Edelstahl gefertigt. Sicherheitsmikroschalter am Behälterdeckel - Serienmäßig mit Rauchgrau Polycarbonat-Deckel. Auf Wunsch weitere Zusatzausstattungen, wie z. B. Gitterabdeckung aus Edelstahl AISI 304.

**ES Amasadora de espiral con cabeza fija.** Máquina para realizar diferentes tipos de masas, se aconseja especialmente para masas como pan, pizza y tortillas. Estructura recubierta con pintura anti-arañazos - partes en contacto con los alimentos (bol, espiral y barra para romper la masa) de acero inoxidable - microinterrupción de seguridad en la tapa del bol - tapa de policarbonato fumé de serie. Se pueden pedir unos extras o accesorios como tapa con red de acero inoxidable AISI 304.

**RU Спиральный тестомес с неподвижной траверсой.** Машина для приготовления различных видов теста, особенно подходит для мягкого теста, такого как хлеб, пицца и пиадина. Покрытие устойчивой к царапинам краской. Детали, контактирующие с пищевыми продуктами, такие как дежа, спирали и мешалка, изготовлены из нержавеющей стали. Предохранительный микровыключатель на крышке. в стандартной комплектации крышка из поликарбоната дымчато-серого цвета. Дополнительное оборудование, например, решетчатая крышка из нержавеющей стали AISI 304, по запросу.

	12SB	18SB
		
	0,75 kW (1 HP) 0,75/0,55 kW (1/0,75 HP) - 2 <sup>nd</sup> speed (optional)	
	230-400V/3N/50Hz	
	230V/1N/50Hz	
	36 Kg/h	54 Kg/h
	12 Kg	18 Kg
	16 L (ø 320 x 210(h) mm)	22 L (ø 360 x 210(h) mm)
	90 rpm 90 - 180 rpm - 2 <sup>nd</sup> speed (optional)	
	632 x 320 x 750÷932(h) mm	653 x 380 x 750÷951(h) mm
		
	58 Kg	60 Kg
	68 Kg	70 Kg
	700 x 460 x 890(h) mm	
	0,250 m³	

25SB  
38SB

New



25SB

# Impastatrice a spirale con testa fissa

SPIRAL KNEADER  
PETRIN A SPIRAL  
SPIRALTEIGKNETMASCHINE  
AMASADORA DE ESPIRAL  
СПИРАЛЬНЫЙ ТЕСТОМЕС

**IT Impastatrice a spirale con testa fissa.** Macchina per realizzare diversi tipi di impasto, indicata soprattutto per impasti teneri come pane, pizza e piada. Struttura rivestita con vernice antigraffio - parti a contatto con gli alimenti quali vasca, spirale ed asta spacca pasta sono in acciaio inox - microinterruttore di sicurezza su coperchio vasca - coperchio in polycarbonato fumè di serie. Vari optional a richiesta, tra cui coperchio grigliato in acciaio inox AISI 304.

**EN Spiral kneader with fixed head.** Machine for the processing of different types of dough, especially suitable for soft doughs such as bread, pizza and piadina. Structure coated with scratch-proof paint - parts in contact with food such as bowl, spiral and dough splitting rod are made of stainless steel - safety microswitch on bowl lid - smoked polycarbonate lid as standard. Different options on request, including AISI 304 stainless steel grilled cover.

**FR Pétrin à spirale avec tête fixe.** Machine pour le pétrissage de différents types de pâte, particulièrement adaptée aux pâtes tendres telles que le pain, la pizza et la piadina. Structure recouverte de peinture anti-rayures - les parties en contact avec les aliments telles que la cuve, la spirale et la brise-pâte sont en acier inox - microrupteur de sécurité sur le couvercle de la cuve - couvercle en polycarbonate fumé de série. Différentes options sur demande, incluant couvercle grillé en acier inox AISI 304.

**DE Spiralteigknetmaschine mit festem Kopf.** Maschine zur Zubereitung verschiedener Teigarten, besonders geeignet für weiche Teige wie Brot, Pizza und Piadina. Struktur mit kratzfester Lackierung beschichtet - Teile, die mit Lebensmitteln in Berührung kommen, wie Schüssel, Spirale und Teigknetstab, sind aus Edelstahl gefertigt. Sicherheitsmikroschalter am Behälterdeckel - Serienmäßig mit Rauchgrau Polycarbonat-Deckel. Auf Wunsch weitere Zusatzausstattungen, wie z. B. Gitterabdeckung aus Edelstahl AISI 304.

**ES Amasadora de espiral con cabeza fija.** Máquina para realizar diferentes tipos de masas, se aconseja especialmente para masas como pan, pizza y tortillas. Estructura recubierta con pintura anti-arañazos - partes en contacto con los alimentos (bol, espiral y barra para romper la masa) de acero inoxidable - microinterrupción de seguridad en la tapa del bol - tapa de polycarbonato fumé de serie. Se pueden pedir unos extras o accesorios como tapa con red de acero inoxidable AISI 304.

**RU Спиральный тестомес с неподвижной траверсой.** Машина для приготовления различных видов теста, особенно подходит для мягкого теста, такого как хлеб, пицца и пиадина. Покрытие устойчивой к царапинам краской. Детали, контактирующие с пищевыми продуктами, такие как дежа, спирали и мешалка, изготовлены из нержавеющей стали. Предохранительный микровыключатель на крышке. в стандартной комплектации крышка из поликарбоната дымчато-серого цвета. Дополнительное оборудование, например, решетчатая крышка из нержавеющей стали AISI 304, по запросу.

	25SB	38SB
	1,5 kW (2 HP) 1,5/1,1 kW (2/1,5 HP) - 2 <sup>nd</sup> speed (optional)	
	230-400V/3N/50Hz	
	230V/1N/50Hz	
	75 Kg/h	114 Kg/h
	25 Kg	38 Kg
	32 L (ø 400 x 260(h) mm)	42 L (ø 450 x 260(h) mm)
	90 rpm 90 - 180 rpm - 2 <sup>nd</sup> speed (optional)	
	762 x 420 x 864÷1123(h) mm	800 x 474 x 866÷1148(h) mm
		
	92 Kg	96 Kg
	102 Kg	106 Kg
	850 x 550 x 1055(h) mm	
	0,490 m³	

# 50SB

New



## Impastatrice a spirale con testa fissa

SPIRAL KNEADER  
PETRIN A SPIRAL  
SPIRALTEIGKNETMASCHINE  
AMASADORA DE ESPIRAL  
СПИРАЛЬНЫЙ ТЕСТОМЕС

**IT Impastatrice a spirale con testa fissa.** Macchina per realizzare diversi tipi di impasto, indicata soprattutto per impasti teneri come pane, pizza e piada. Struttura rivestita con vernice antigraffio - parti a contatto con gli alimenti quali vasca, spirale ed asta spacca pasta sono in acciaio inox - microinterruttore di sicurezza su coperchio vasca - disponibile solo con coperchio grigliato in acciaio inox AISI 304.













**EN Spiral kneader with fixed head.** Machine for the processing of different types of dough, especially suitable for soft doughs such as bread, pizza and piadina. Structure coated with scratch-proof paint - parts in contact with food such as bowl, spiral and dough splitting rod are made of stainless steel - safety microswitch on bowl lid. Only available with AISI 304 stainless steel grilled cover.

**FR Pétrin à spirale avec tête fixe.** Machine pour le pétrissage de différents types de pâte, particulièrement adaptée aux pâtes tendres telles que le pain, la pizza et la piadina. Structure recouverte de peinture anti-rayures - les parties en contact avec les aliments telles que la cuve, la spirale et la brise-pâte sont en acier inox - microrupteur de sécurité sur le couvercle de la cuve. Uniquement disponible avec couvercle grillé en acier inox AISI 304.

**DE Spiralteigknetmaschine mit festem Kopf.** Maschine zur Zubereitung verschiedener Teigarten, besonders geeignet für weiche Teige wie Brot, Pizza und Piadina. Struktur mit kratzfester Lackierung beschichtet - Teile, die mit Lebensmitteln in Berührung kommen, wie Schüssel, Spirale und Teigknetstab, sind aus Edelstahl gefertigt. Sicherheitsmikroschalter am Behälterdeckel - nur mit Gitterabdeckung aus Edelstahl AISI 304 erhältlich.

**ES Amasadora de espiral con cabeza retráctil y bol extraíble.** Máquina para realizar diferentes tipos de masas, se aconseja especialmente para masas como pan, pizza y tortillas. Estructura recubierta con pintura anti-arañazos - partes en contacto con los alimentos (bol, espiral y barra para romper la masa) de acero inoxidable - microinterruptor de seguridad en la tapa del bol. Solamente con tapa con red de acero inoxidable AISI 304.

**RU Спиральный тестомес с неподвижной траверсой.** Машина для приготовления различных видов теста, особенно подходит для мягкого теста, такого как хлеб, пицца и пиадина. Покрытие устойчивой к царапинам краской. Детали, контактирующие с пищевыми продуктами, такие как дежа, спирали и мешалка, изготовлены из нержавеющей стали. Предохранительный микровыключатель на крышке. Поставляется только с крышкой из нержавеющей стали AISI 304.

	<b>50SB</b>
	2,2 kW (3 HP) 3,5/2,5 kW (4,7/3,3 HP) - 2 <sup>nd</sup> speed (optional)
	230-400V/3N/50Hz
	150 Kg/h
	50 Kg
	62 L (ø 500 x 310(h) mm)
	80 rpm 80 - 160 rpm - 2 <sup>nd</sup> speed (optional)
	927 x 520 x 1074÷1393(h) mm
	
	177 Kg
	187 Kg
	1055 x 600 x 1276(h) mm
	0,803 m³

15LN  
20LN

New



20LN

CON ASTA SPACCA PASTA  
WITH CONTRAST ROD

# Impastatrice a spirale light

SPIRAL KNEADER  
PETRIN A SPIRAL  
SPIRALTEIGKNETMASCHINE  
AMASADORA DE ESPIRAL  
СПИРАЛЬНЫЙ ТЕСТОМЕС

IT Impastatrice a spirale light. Macchina per realizzare diversi tipi di impasto, indicata soprattutto per impasti teneri come pane, pizza e piada. Struttura rivestita con vernice antigraffio - parti a contatto con gli alimenti (vasca, spirale) in acciaio inox AISI 304 - microinterruttore di sicurezza su coperchio vasca - coperchio in policarbonato fumè. Vari optional a richiesta, tra cui coperchio grigliato in acciaio inox AISI 304.

EN Spiral kneader light. Machine for the processing of different types of dough, especially suitable for soft doughs such as bread, pizza and piadina. Structure coated with scratch-proof paint - parts in contact with food, such as bowl and spiral, are made of stainless steel AISI 304 - safety microswitch on bowl lid - smoked polycarbonate lid as standard. Different options on request, including AISI 304 stainless steel grilled cover.

FR Pétrin à spirale "light". Machine pour le pétrissage de différents types de pâte, particulièrement adaptée aux pâtes tendres telles que le pain, la pizza et la piadina. Structure recouverte de peinture anti-rayures - les parties en contact avec les aliments, telles que la cuve et la spirale, sont en acier inox AISI 304 - microinterrupteur de sécurité sur le couvercle de la cuve - couvercle en polycarbonate fumé de série. Différentes options sur demande, incluant couvercle grillé en acier inox AISI 304.

DE Spiraleteigknetmaschine "Light". Maschine zur Zubereitung von verschiedenen Teigttypen, besonders geeignet für weichen Brot, Piada und Pizzateig. Struktur mit kratzfestem Lack beschichtet - Teile in Kontakt mit Lebensmitteln (Behälter und Spirale) aus Edelstahl AISI 304 - Sicherheitsmikroschalter am Behälterdeckel. Deckel in rauchfarbenem Polykarbonat serienmäßig. Auf Anfrage sind verschiedene Zubehörteile erhältlich, einschließlich der Gitterabdeckung aus Edelstahl AISI 304.

ES Amasadora de espiral light. Máquina para realizar diferentes tipos de masas, se aconseja especialmente para masas como pan, pizza y tortillas. Estructura recubierta con pintura anti-arañazos - partes en contacto con los alimentos (bol y espiral) de acero inoxidable AISI 304 - microinterruptor de seguridad en tapa del bol - tapa de policarbonato fumé. Se pueden pedir unos extras o accesorios como tapa con red de acero inoxidable AISI 304.

RU Спиральный тестомес "Light". Машина для приготовления различных видов теста, особенно подходит для мягкого теста, такого как хлеб, пицца и пиадина. Покрытие устойчивой к царапинам краской. Детали, контактирующие с пищевыми продуктами, такие как дежа и спирали, изготовлены из нержавеющей стали AISI 304. Предохранительный микровыключатель на крышке. в стандартной комплектации крышка из поликарбоната дымчато-серого цвета. Дополнительное оборудование, например, решетчатая крышка из нержавеющей стали AISI 304, по запросу.

	15LN	20LN
	0,37 kW (0,5 HP) 0,55/0,37 kW (0,7/0,5 HP) only 3 PH 2nd speed (optional)	
	230-400V/3N/50Hz	
	230V/1N/50Hz	
	30 Kg/h	48 Kg/h
	10 Kg	16 Kg
	15 L ø 320 x 210(h) mm	20 L ø 360 x 210(h) mm
	90 rpm 90 - 180 rpm 2nd speed (optional)	
	337 x 627 x 652÷930(h) mm	380 x 653 x 652÷952(h) mm
		
	52 Kg	55 Kg
	62 Kg	65 Kg
	460 x 700 x 890(h) mm	
	0,29 m³	

30LN  
40LN

New



30LN

CON ASTA SPACCA PASTA  
WITH CONTRAST ROD

# Impastatrice a spirale light

SPIRAL KNEADER  
PETRIN A SPIRAL  
SPIRALTEIGKNETMASCHINE  
AMASADORA DE ESPIRAL  
СПИРАЛЬНЫЙ ТЕСТОМЕС



**IT** Impastatrice a spirale light. Macchina per realizzare diversi tipi di impasto, indicata soprattutto per impasti teneri come pane, pizza e piada. Struttura rivestita con vernice antigraffio - parti a contatto con gli alimenti (vasca, spirale) in acciaio inox AISI 304 - microinterruttore di sicurezza su coperchio vasca - coperchio in policarbonato fumè. Vari optional a richiesta, tra cui coperchio grigliato in acciaio inox AISI 304.

**EN** Spiral kneader light. Machine for the processing of different types of dough, especially suitable for soft doughs such as bread, pizza and piadina. Structure coated with scratch-proof paint - parts in contact with food, such as bowl and spiral, are made of stainless steel AISI 304 - safety microswitch on bowl lid - smoked polycarbonate lid as standard. Different options on request, including AISI 304 stainless steel grilled cover.

**FR** Pétrin à spirale "light". Machine pour le pétrissage de différents types de pâte, particulièrement adaptée aux pâtes tendres telles que le pain, la pizza et la piadina. Structure recouverte de peinture anti-rayures - les parties en contact avec les aliments, telles que la cuve et la spirale, sont en acier inox AISI 304 - microinterrupteur de sécurité sur le couvercle de la cuve - couvercle en polycarbonate fumé de série. Différentes options sur demande, incluant couvercle grillé en acier inox AISI 304.

**DE** Spiraleteigknetmaschine "Light". Maschine zur Zubereitung von verschiedenen Teigtypen, besonders geeignet für weichen Brot, Piada und Pizzateig. Struktur mit kratzfestem Lack beschichtet - Teile in Kontakt mit Lebensmitteln (Behälter und Spirale) aus Edelstahl AISI 304 - Sicherheitsmikroschalter am Behälterdeckel. Deckel in rauchfarbenem Polykarbonat serienmäßig. Auf Anfrage sind verschiedene Zubehörteile erhältlich, einschließlich der Gitterabdeckung aus Edelstahl AISI 304.

**ES** Amasadora de espiral light. Máquina para realizar diferentes tipos de masas, se aconseja especialmente para masas como pan, pizza y tortillas. Estructura recubierta con pintura anti-arañazos - partes en contacto con los alimentos (bol y espiral) de acero inoxidable AISI 304 - microinterruptor de seguridad en tapa del bol - tapa de policarbonato fumé. Se pueden pedir unos extras o accesorios como tapa con red de acero inoxidable AISI 304.

**RU** Спиральный тестомес "Light". Машина для приготовления различных видов теста, особенно подходит для мягкого теста, такого как хлеб, пицца и пиадина. Покрытие устойчивой к царапинам краской. Детали, контактирующие с пищевыми продуктами, такие как дежа и спирали, изготовлены из нержавеющей стали AISI 304. Предохранительный микровыключатель на крышке. в стандартной комплектации крышка из поликарбоната дымчато-серого цвета. Дополнительное оборудование, например, решетчатая крышка из нержавеющей стали AISI 304, по запросу.

	30LN	40LN
	0,75 kW (1 HP) 0,75/0,55 kW (1/0,75 HP) 2 <sup>nd</sup> speed (optional)	1,1 kW (1 HP) 0,75/1,1 kW (1/1,5 HP) 2 <sup>nd</sup> speed (optional)
	230-400V/3N/50Hz	
	230V/1N/50Hz	
	75 Kg/h	108 Kg/h
	25 Kg	36 Kg
	30 L (ø 400 x 260(h) mm)	40 L (ø 450 x 260(h) mm)
	90 rpm 90 - 180 rpm 2 <sup>nd</sup> speed (optional)	
	415 x 763 x 753÷1123(h) mm	474 x 800 x 765÷1159(h) mm
		
	88 Kg	90 Kg
	98 Kg	100 Kg
	550 x 850 x 1060(h) mm	
	0,49 m³	



COPERCHIO GRIGLIATO  
STAINLESS STEEL GRIDDED LID



CARRELLO - TROLLEY



MANIGLIE ESTRAZIONE PENTOLA  
POT EXTRACTION HANDLES



TIMER DIGITALE  
DIGITAL TIMER



TIMER MECCANICO  
MECCANIC TIMER

	7 SB	12 SB-SR-SL	15 LN	18 SB-SR-SL	20 LN	25 SB-SR-SL	30 LN	38 SB-SR-SL	40 LN	50 SB-SR-SL
A	420 mm	520 mm			600 mm			760 mm		
B	250 mm	280 mm			330 mm		380 mm		470 mm	
C					80 mm				130 mm	
D					130 mm				170 mm	

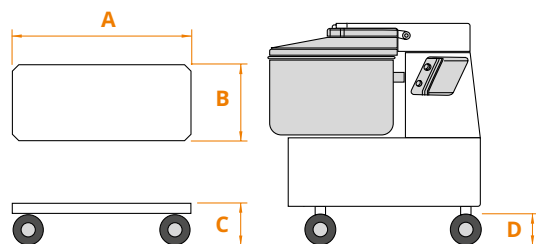

Optional  
impastatrici

ACCESSORIES  
ACCESSOIRES  
ZUBEHÖR  
ACCESORIOS  
AKCECCYAPЫ

<b>Mod.</b>	<b>KITRUOTEIMSN</b> Kit ruote - Set of wheels - Kit de roues Rädersatz - Juego de ruedas - Набор колёс
7-12-18-25-38 SB-SR-SL	
15-20-30-40 LN	

<b>Mod.</b>	<b>KITRUOTEIM50N</b> Kit ruote - Set of wheels - Kit de roues Rädersatz - Juego de ruedas - Набор колёс
50 SB-SR-SL	

<b>Mod.</b>	<b>Carrello - Trolley - Chariot - Wagen - Carrito - Тележка</b>
7 SB-SR-SL	CAVIMP7R
12-18 SB-SR-SL 15-20LN	CAVIMP1218R
25 SB-SR-SL 30-40LN	CAVIMP25R
38 SB-SR-SL	CAVIMP38R
50 SB-SR-SL	CAVIMPPF30BR

<b>Mod.</b>	<b>Salvatore Motor overload protection Discontacteur Motorschutz Interruptor de sobrecarga Защита двигателя</b>
7-12-18 25-38-50 SB-SR-SL	
15-20-30-40 LN	

<b>Mod.</b>	<b>Timer meccanico - Mechanical timer Minuterie mécanique - Mechanischer Timer Temporizador mecánico - Механический таймер</b>
7-12-18 25-38-50 SB-SR-SL	
15-20-30-40 LN	

<b>Mod.</b>	<b>Coperchio grigliato inox - Stainless steel gridded lid Couvercle grillé en acier inox - Gitterdeckel aus Edelstahl Tapa con red de acero inoxidable Поставляется с крышкой из нержавеющей стали</b>
12-18-25-38 SB-SR-SL	
15-20-30-40 LN	

<b>Mod.</b>	<b>Timer digitale, solo con norme CE, no con salvatore Digital timer, only CE, not with motor overload protection Minuteur numérique, seulement CE, pas avec discontacteur Digitalzeitregler, nur nach CE-Normen, nicht mit Motorschutz Temporizador digital, sólo CE, no con interruptor de sobrecarga Цифровой таймер, только по стандартам CE, не с защитой двигателя</b>
12-18 25-38-50 SB-SR-SL	

<b>Mod.</b>	<b>ACMANIM Maniglie estrazione pentola Pot extraction handles Poignées d'extraction de la cuve Schüsselauszehgriffe Manijas para extraer el bol Ручки для извлечения дежи</b>
12-18-25 38-50 SR	

IM7 SB

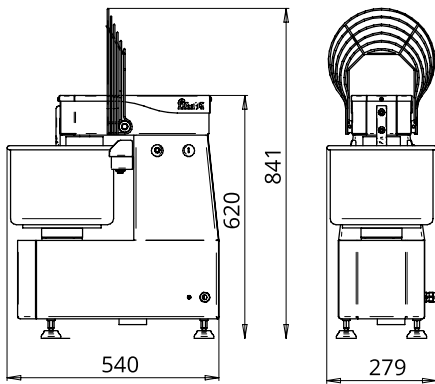

IM12 SB/SL/SR

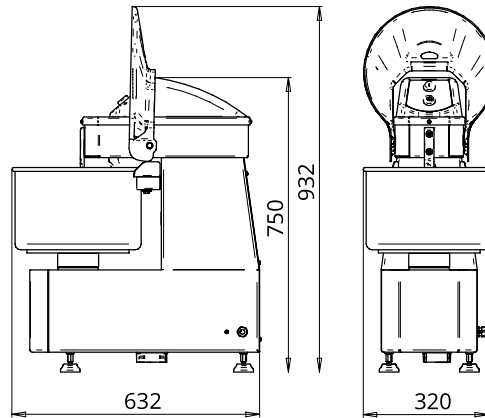

IM18 SB/SL/SR

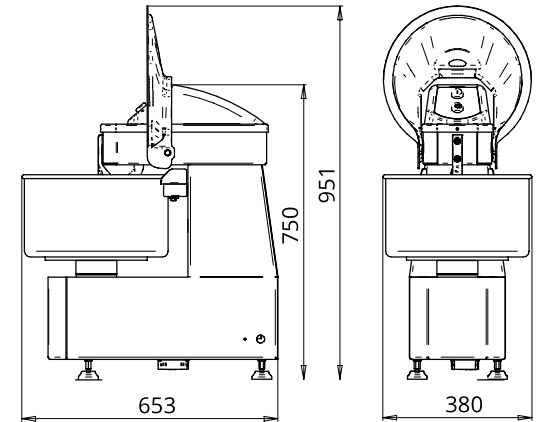

IM25 SB/SL/SR

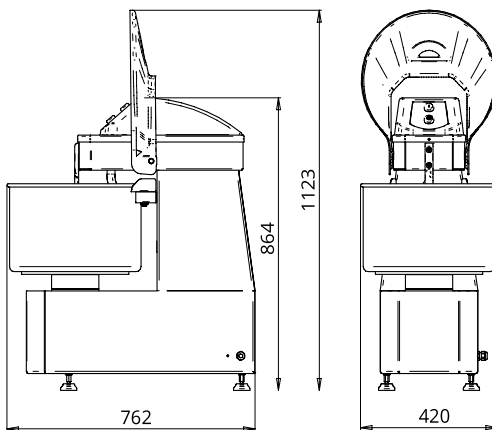

IM38 SB/SL/SR

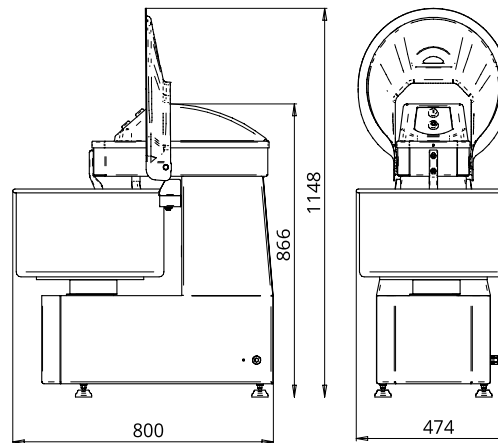

IM50 SB/SL/SR

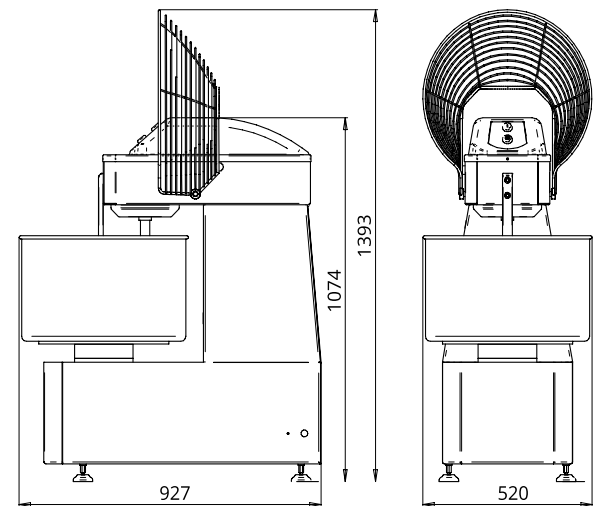

IM15 LN

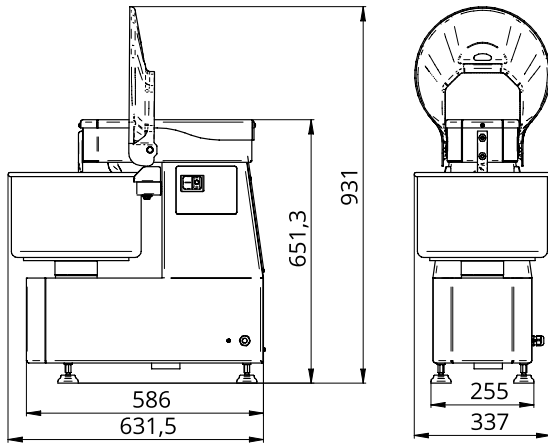

IM20 LN

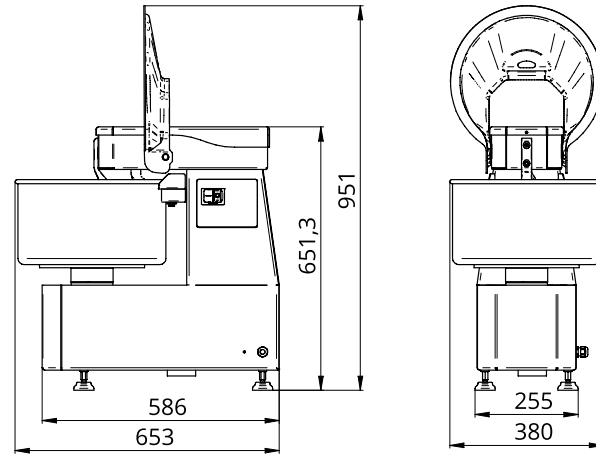

IM30 LN

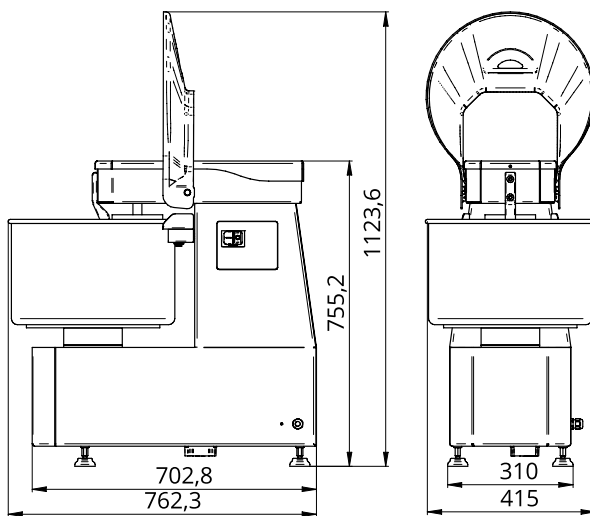

IM40 LN

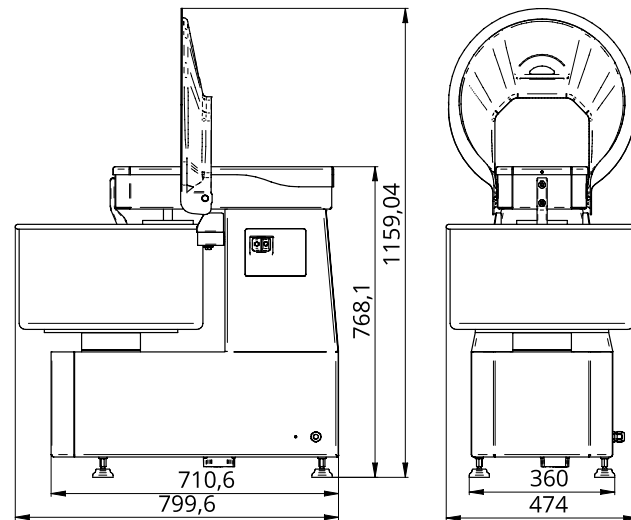

PLN40D  
PLN60D  
PLN80D



# Impastatrice planetaria

variatore di velocità e comandi digitali

PLANETARY MIXER  
MÉLANGEUR PLANÉTAIRE  
PLANETENMISCHER  
AMASADORA PLANETARIA  
ПЛАНЕТАРНЫЙ ТЕСТОМЕС

IT Impastatrice planetaria con variatore di velocità e comandi digitali. Macchina per diversi tipi di impasto quali pizza, pane, biscotti, croissant, brioches, bigné, pan di spagna, pasta frolla, meringhe, puree, salse varie, panna montata, ecc. Struttura rivestita con vernice antigraffio - carter superiore in ABS - vasca, frusta e protezione vasca in acciaio inox AISI 304 - uncino e spatola in alluminio - microinterruttore su protezione vasca - vasca estraibile - innesto rapido utensili.











EN Planetary mixer with speed variator and digital controls. Machine for different types of dough such as pizza, bread, biscuits, croissants, brioches, cream puffs, sponge cake, shortcrust pastry, meringues, purees, various sauces, whipped cream, etc.. Frame coated with scratch-proof paint - upper casing in ABS - bowl, whip and bowl protector in stainless steel AISI 304 - hook and spatula in aluminium - microswitch on bowl protector - removable bowl - quick tool connection.

FR Mélangeur planétaire avec variateur de vitesse et commandes numériques. Machine pour différents types de pâte tels que pizza, pain, biscuits, croissants, brioches, pains à la crème, gâteau éponge, pâte brisée, meringues, purées, sauces, crème fouettée, etc. Corps recouvert de peinture anti-rayures - carter supérieur en ABS - cuve, fouet et protection de la cuve en acier inox AISI 304 - crochet et spatule en aluminium - microinterrupteur sur la cuve la protection de la cuve - cuve amovible - dégagement rapide des outils.

DE Planetenmischer mit Drehzahlregler und digitaler Steuerung. Maschine für verschiedene Teigarten wie Pizza, Brot, Kekse, Croissants, Hörnchen, Beignets, Biskuitkuchen, Mürbeteig, Meringues, Pürees, verschiedene Soßen, Schlagsahne, usw... Gehäuse mit kratzfester Lackierung - Obergehäuse aus Kunststoff - Teigschüssel, Rührerinsatz und Wannenschutz aus Edelstahl AISI 304 - Haken und Spachtel aus Aluminium - Mikroschalter an Wannenschutz und Teigschüssel - ausziehbare Teigschüssel - Werkzeugschnellkupplung.

ES Amasadora planetaria con variador de velocidad y mandos digitales. Máquina para varios tipos de masas, como pizza, pan, galletas, croissants, brioches, petisúes, bizcocho, merengues, pureas, varias salsas, nata montada, etc. Estructura recubierta con pintura anti-arañazos, cárter superior de ABS - bol, batidor y protección del bol de acero inoxidable AISI 304 - gancho y espátula de aluminio - microinterruptor en la protección del bol - bol extraíble - enganche rápido de utensilios.

RU Планетарный тестомес с регулятором скорости и цифровым управлением. Машина для приготовления различных видов теста, например, для пиццы, хлеба, печенья, круассанов, бисквита, песочного теста, безе, пюре, различных соусов, взбитых сливок и т.д. Корпус покрыт устойчивой к царапинам краской - пластиковый верхний кожух - дежа для теста, мешалка и защита чаши из нержавеющей стали AISI 304 - крючок и лопатка из алюминия - микровыключатель на защите чаши и дежи для теста - извлекаемая дежа для теста - быстроразъемная муфта.

	PLN40D	PLN60D	PLN80D
	2,2 kW (3 HP)	3 kW (4 HP)	
	400V/3/50-60Hz		
	Digitale - Digital - Цифровой		
	40 L	60 L	80 L
	min. 30 - max. 120 rpm		
	910 x 650 x 1520(h) mm	1000 x 680 x 1600(h) mm	
			
	250 Kg	280 Kg	290 Kg
	260 Kg	295 Kg	310 Kg
	1100 x 800 x 1800(h) mm		
	1,584 m³		

# PLN12BV PLN20BV



PLN12BV

## Impastatrice planetaria

variatore con inverter e comandi meccanici

PLANETARY MIXER  
MÉLANGEUR PLANÉTAIRE  
PLANETENMISCHER  
AMASADORA PLANETARIA  
ПЛАНЕТАРНЫЙ ТЕСТОМЕС

136



GUARDA IL VIDEO  
WATCH THE VIDEO

 **fimar**



IT Impastatrice planetaria con variatore di velocità, comandi meccanici e inverter. Macchina per diversi tipi di impasto quali pizza, pane, biscotti, croissant, brioches, bignè, pan di spagna, pasta frolla, meringhe, puree, salse varie, panna montata, ecc. Struttura rivestita con vernice antigraffio, carter superiore in ABS - vasca e frusta in acciaio inox AISI 304 - uncino e spatola in alluminio - microinterruttore su protezione vasca - vasca estraibile - innesto rapido utensili - modelli da banco.

EN Planetary mixer with speed variator and mechanical controls. Machine for different types of dough such as pizza, bread, biscuits, croissants, brioches, cream puffs, sponge cake, shortcrust pastry, meringues, purees, various sauces, whipped cream, etc.. Frame coated with scratch-proof paint - upper casing in ABS - bowl, whip in stainless steel AISI 304 - hook and spatula in aluminium - microswitch on bowl protector - removable bowl - quick tool connection. Counter model.

FR Mélangeur planétaire avec variateur de vitesse et commandes mécaniques. Machine pour différents types de pâte tels que pizza, pain, biscuits, croissants, brioches, pains à la crème, gâteau éponge, pâte Brisée, meringues, purées, sauces, crème fouettée, etc. Corps recouvert de peinture anti-rayures - carter supérieur en ABS - cuve, fouet en acier inox AISI 304 - crochet et spatule en aluminium - microinterrupteur sur la cuve la protection de la cuve - cuve amovible - dégageement rapide des outils. Modèle à poser.

DE Planetenmischer mit Drehzahlregler, mechanischer Steuerung und Umrichter. Maschine für verschiedene Teigarten wie Pizza, Brot, Kekse, Croissants, Hörnchen, Beignets, Biskuitkuchen, Mürbeteig, Meringues, Pürees, verschiedene Soßen, Schlagsahne, usw... Gehäuse mit kratzfester Lackierung - Obergehäuse aus Kunststoff - Teigschüssel, Rührersatz aus Edelstahl AISI 304 - Haken und Spachtel aus Aluminium - Mikroschalter an Wannenschutz und Teigschüssel - ausziehbare Teigschüssel - Werkzeugschnellkupplung. Tischmodell.

ES Amasadora planetaria con variador de velocidad y mandos mecánicos e invertidor. Máquina para varios tipos de masas, como pizza, pan, galletas, croissants, brioches, petisúes, bizcocho, merengues, pureas, varias salsas, nata montada, etc. Estructura recubierta con pintura anti-arañazos, cárter superior de ABS - bol y batidorde acero inoxidable AISI 304 - gancho y espátula de aluminio - microinterruptor en la protección del bol - bol extraíble - enganche rápido de utensilios. Modelos para bancos de trabajo.

RU Планетарный тестомес с регулятором скорости, механическим управлением и инвертором. Машина для приготовления различных видов теста, например, для пиццы, хлеба, печенья, круассанов, бисквита, песочного теста, безе, пюре, различных соусов, взбитых сливок и т.д. Корпус покрыт устойчивой к царапинам краской - дежа для теста и мешалка из нержавеющей стали AISI 304 - крючок и лопатка из алюминия - микровыключатель на защите чаши и дежи для теста - извлекаемая дежа для теста - быстроразъемная муфта. Настольная модель.

	PLN12BV	PLN20BV
	0,5 kW (0,7 HP)	
	230V/1N/50-60Hz	
	Meccanico - Mechanical - Механический 0÷30'	
	10 L	20 L
	min. 30 - max.120 rpm	
	520 x 400 x 630(h) mm	600 x 470 x 711(h) mm
		
	47 Kg	56 Kg
	55 Kg	64 Kg
	750 x 490 x 900(h) mm	
	0,331 m³	

PLN20V  
PLN40V  
PLN60V  
PLN80V



PLN40V

# Impastatrice planetaria

variatore con inverter e comandi meccanici

PLANETARY MIXER  
MÉLANGEUR PLANÉTAIRE  
PLANETENMISCHER  
AMASADORA PLANETARIA  
ПЛАНЕТАРНЫЙ ТЕСТОМЕС

**IT** Impastatrice planetaria con variatore di velocità, comandi meccanici e inverter. Macchina per diversi tipi di impasto quali pizza, pane, biscotti, croissant, brioches, bignè, pan di spagna, pasta frolla, meringhe, puree, salse varie, panna montata, ecc. Struttura rivestita con vernice antigraffio, carter superiore in ABS - vasca, frusta e protezione vasca in acciaio inox AISI 304 - uncino e spatola in alluminio - microinterruttore su protezione vasca - vasca estraibile - innesto rapido utensili.













**EN** Planetary mixer with speed variator and mechanical controls and inverter. Machine for different types of dough such as pizza, bread, biscuits, croissants, brioches, cream puffs, sponge cake, shortcrust pastry, meringues, purees, various sauces, whipped cream, etc.. Frame coated with scratch-proof paint - upper casing in ABS - bowl, whip and bowl protector in stainless steel AISI 304 - hook and spatula in aluminium - microswitch on bowl protector - removable bowl - quick tool connection.

**FR** Mélangeur planétaire avec variateur de vitesse et commandes mécaniques. Machine pour différents types de pâte tels que pizza, pain, biscuits, croissants, brioches, pains à la crème, gâteau éponge, pâte Brisée, meringues, purées, sauces, crème fouettée, etc. Corps recouvert de peinture anti-rayures - carter supérieur en ABS - cuve, fouet et protection de la cuve en acier inox AISI 304 - crochet et spatule en aluminium - microinterrupteur sur la cuve la protection de la cuve - cuve amovible - dégagement rapide des outils.

**DE** Planetenmischer mit Drehzahlregler, mechanischer Steuerung und Umrichter. Maschine für verschiedene Teigarten wie Pizza, Brot, Kekse, Croissants, Hörnchen, Beignets, Biskuitkuchen, Mürbeteig, Meringues, Pürees, verschiedene Soßen, Schlagsahne, usw... Gehäuse mit kratzfester Lackierung - Obergehäuse aus Kunststoff - Teigschüssel, Rührersatz und Wannenschutz aus Edelstahl AISI 304 - Haken und Spachtel aus Aluminium - Mikroschalter an Wannenschutz und Teigschüssel - ausziehbare Teigschüssel - Werkzeugschnellkupplung.

**ES** Amasadora planetaria con variador de velocidad y mandos mecánicos e invertidor. Máquina para varios tipos de masas, como pizza, pan, galletas, croissants, brioches, petisúes, bizcocho, merengues, pureas, varias salsas, nata montada, etc. Estructura recubierta con pintura anti-arañazos, cárter superior de ABS - bol, batidor y protección del bol de acero inoxidable AISI 304 - gancho y espátula de aluminio - microinterruptor en la protección del bol - bol extraíble - enganche rápido de utensilios.

**RU** Планетарный тестомес с регулятором скорости, механическим управлением и инвертором. Машина для приготовления различных видов теста, например, для пиццы, хлеба, печенья, круассанов, бисквита, песочного теста, безе, пюре, различных соусов, взбитых сливок и т.д. Корпус покрыт устойчивой к царапинам краской - пластиковый верхний кожух - дежа для теста, мешалка и защита чаши из нержавеющей стали AISI 304 - крючок и лопатка из алюминия - микровыключатель на защите чаши и дежи для теста - извлекаемая дежа для теста - быстроразъемная муфта.

	PLN20V	PLN40V	PLN60V	PLN80V
	0,75 kW (1 HP)	2,2 kW (3 HP)	3 kW (4 HP)	
	400V/3/50-60Hz			
	230V/1N/50-60Hz	-		
	Meccanico - Mechanical - Механический 0+30'			
	20 L	40 L	60 L	80 L
	min. 30 - max.120 rpm			
	700 x 500 x 1200(h) mm	910 x 650 x 1520(h) mm	1000 x 680 x 1600(h) mm	
				
	110 Kg	250 Kg	280 Kg	290 Kg
	136 Kg	260 Kg	295 Kg	310 Kg
	890 x 680 x 1400(h) mm	1100 x 800 x 1800(h) mm		
	0,847 m³	1,584 m³		

PLN20M  
PLN40M  
PLN60M



Impastatrice planetaria  
3 velocità con comandi meccanici

PLANETARY MIXER  
MÉLANGEUR PLANÉTAIRE  
PLANETENMISCHER  
AMASADORA PLANETARIA  
ПЛАНЕТАРНЫЙ ТЕСТОМЕС

**IT** Impastatrice planetaria con variatore a 3 velocità e comandi meccanici. Macchina per diversi tipi di impasto quali pizza, pane, biscotti, croissant, brioches, bigné, pan di spagna, pasta frolla, meringhe, puree, salse varie, panna montata, ecc. Struttura rivestita con vernice antigraffio, carter superiore in ABS - vasca, frusta e protezione vasca in acciaio inox AISI 304 - uncino e spatola in alluminio - microinterruttore su protezione vasca - vasca estraibile - innesto rapido utensili.





**EN** Planetary mixer with 3 speeds variator and mechanical controls. Machine for different types of dough such as pizza, bread, biscuits, croissants, brioches, cream puffs, sponge cake, shortcrust pastry, meringues, purees, various sauces, whipped cream, etc...Frame coated with scratch-proof paint - upper casing in ABS - bowl, whip and bowl protector in stainless steel AISI 304 - hook and spatula in aluminium - microswitch on bowl protector - removable bowl - quick tool connection.

**FR** Mélangeur planétaire avec variateur à 3 vitesses et commandes mécaniques. Machine pour différents types de pâte tels que pizza, pain, biscuits, croissants, brioches, pains à la crème, gâteau éponge, pâte Brisée, meringues, purées, sauces, crème fouettée, etc. Corps recouvert de peinture anti-rayures - carter supérieur en ABS - cuve, fouet et protection de la cuve en acier inox AISI 304 - crochet et spatule en aluminium - microinterrupteur sur la cuve la protection de la cuve - cuve amovible - dégagement rapide des outils.

**DE** Planetenmischer mit 3-Gänge-Drehzahlregler und mechanischer Steuerung. Maschine für verschiedene Teigarten wie Pizza, Brot, Kekse, Croissants, Hörnchen, Beignets, Biskuitkuchen, Mürbeteig, Meringues, Pürees, verschiedene Soßen, Schlagsahne, usw..Gehäuse mit kratzfester Lackierung - Obergehäuse aus Kunststoff - Teigschüssel, Rührersatz und Wannenschutz aus Edelstahl AISI 304 - Haken und Spachtel aus Aluminium - Mikroschalter an Wannenschutz und Teigschüssel - ausziehbare Teigschüssel - Werkzeugschnellkupplung.

**ES** Amasadora planetaria con variador de 3 velocidades y mandos mecánicos. Máquina para varios tipos de masas, como pizza, pan, galletas, croissants, brioches, petisúes, bizcocho, merengues, pureas, varias salsas, nata montada, etc. Estructura recubierta con pintura anti-arañazos, cárter superior de ABS - bol, batidor y protección del bol de acero inoxidable AISI 304 - gancho y espátula de aluminio - microinterruptor en la protección del bol - bol extraíble - enganche rápido de utensilios.

**RU** Планетарный тестомес с 3-х скоростным регулятором скорости и механическим управлением. Машина для приготовления различных видов теста, например, для пиццы, хлеба, печенья, круассанов, бисквита, песочного теста, безе, пюре, различных соусов, взбитых сливок и т.д. Корпус покрыт устойчивой к царапинам краской - пластиковый верхний кожух - дежа для теста, мешалка и защита чаши из нержавеющей стали AISI 304 - крючок и лопатка из алюминия - микровыключатель на защите чаши и дежи для теста - извлекаемая дежа для теста - быстроразъемная муфта.

	PLN20M	PLN40M	PLN60M
	0,5/0,75/1,1 kW (0,7/1/1,5 HP)	0,75/1/1,3 kW (1/1,5/1,75 HP)	1,1/1,5/1,7 kW (1,5/2/2,2 HP)
	400V/3/50Hz		
	Meccanico - Mechanical - Механический 0÷30'		
	20 L	40 L	60 L
	30 - 60 - 120 rpm		
	700 x 500 x 1200(h) mm	910 x 650 x 1520(h) mm	1000 x 680 x 1600(h) mm
			
	110 Kg	250 Kg	280 Kg
	136 Kg	260 Kg	295 Kg
	890 x 680 x 1400(h) mm	1100 x 800 x 1800(h) mm	
	0,847 m³	1,584 m³	



# Optional impastatrici planetarie

ACCESSORIES  
ACCESSOIRES  
ZUBEHÖR  
ACCESORIOS  
AKCECCYAPЫ

Mod.	Kit riduzione (vasca + frusta + uncino + spatola) Reduction kit (bowl+whisk + hook + spatula) Kit réduction (cuve + fouet + crochet + spatule) Verringerungssatz (Teigschüssel + Rührreinsatz + Haken + Spachtel) Kit reducción (bol + batidor + gancho + espátula) Редукционный набор (дежа для теста + мешалка + крюк + лопатка)
80/60 L	ACPLNRID8060
80/40 L	ACPLNRID8040
60/40 L	ACPLNRID6040
60/20 L	ACPLNRID6020
40/20 L	ACPLNRID4020

Mod.	Carrello vasca Bowl trolley Chariot cuve Wagen für Teigschüsselwagen carro del Bol Тележка для дежи
PLN40 M-D-V	ACPLN40CAR
PLN60 M-D-V	ACPLN60CAR
PLN80 M-D-V	ACPLN80CAR

Mod.	Vasca Bowl Cuve Teigschüssel Bol Ёмкость	Uncino Hook Crochet Haken Gancho Крюк	Frusta Whisk Fouet Rührreinsatz Batidor Венчик	Spatola Spatula Spatule Schaber Espátula Лопатка
PLN12BV	ACPLN12BL	ACPLN12HK	ACPLN12WP	ACPLN12BR
PLN20BV	ACPLN20BVBL	ACPLN20HK	ACPLN20WP	ACPLN20BR
PLN20 M-V	ACPLN20MBL	ACPLN20HK	ACPLN20WP	ACPLN20BR
PLN40 M-V-D	ACPLN40BL	ACPLN40HK	ACPLN40WP	ACPLN40BR
PLN60 M-V-D	ACPLN60BL	ACPLN60HK	ACPLN60WP	ACPLN60BR
PLN80 V-D	ACPLN80BL	ACPLN80HK	ACPLN80WP	ACPLN80BR

# PF15E

New

# Lilly



# Macchina pasta fresca

\* Trafile escluse.  
Without mould.  
Filières exclues.  
Nudeleinsätze ausgeschlossen.  
Moldes no incluidos.  
Фильера исключен.

PASTA MACHINE  
MACHINE À PÂTE  
NUDELMASCHINE  
MÁQUINA PARA PASTA FRESCA  
МАШИНКА ДЛЯ ПРИГОТОВЛЕНИЯ СВЕЖИХ  
МАКАРОННЫХ ИЗДЕЛИЙ



IT Macchina per la pasta fresca ideale per impastare ed estrarre impasti in diversi formati. Utensile impastatore ed elica in acciaio inox AISI 304 - microinterruttore di sicurezza su coperchio vasca - coperchio con feritoie per permettere l'inserimento di ingredienti anche durante la lavorazione - vasca completamente estraibile per un facile e rapido lavaggio.  
Accessori: trafilè in bronzo di diverso tipo, coltello tagliapasta, carrello e cassette porta pasta fresca.













EN Fresh pasta machine to mix and mould fresh pasta in different shapes. AISI 304 stainless steel kneading hook and blade - grilled lid to add extra ingredients during processing - completely extractable bowl dishwasher safe. Accessories: bronze moulds in different shapes - pasta cutter knife - trolley and fresh pasta containers.

FR Machine à pâtes fraîches idéale pour pétrir et extruder la pâte en différents formats. Crochet pétrisseur et hélice en acier inox AISI 304, microinterrupteur sur le couvercle de la cuve - couvercle grillé pour ajouter les ingrédients pendant la préparation - cuve entièrement amovible pour un lavage rapide et facile. Accessoires : filières en bronze de différents types - couteau coupe-pâtes - chariot et bacs de pâtes fraîches.

DE Frisch-Nudelmachine, ideal zum Kneten und Extrudieren von Frisch-Nudeln in verschiedenen Formen. Kneithaken und Spirale aus Edelstahl AISI 304 - Mikroschalter am Schüsseldeckel - Gitterdeckel zum Hinzufügen zusätzlicher Zutaten während der Verarbeitung - vollständig ausziehbare Schüssel Geschirrspülmaschine geeignet. Zubehör: verschiedene Arten von Nudleinsätze - Nudelschneidmesser - Wagen und Behälter für frische Nudeln.

ES Máquina de pasta fresca ideal para mezclar y moldear masas de diferentes formas. Utensilio de amasado y cuchilla de acero inoxidable AISI 304 - microinterruptor de seguridad en la tapa del bol - tapa con rejillas para añadir ingredientes durante el proceso - bol completamente extraíble para un lavado fácil y rápido. Accesorios: moldes de bronce de diferentes tipos, cortapastas, carro y cajas para pasta fresca.

RU Макаронная установка для приготовления свежих макарон, идеально подходит для замешивания и экструзии свежих макаронных изделий различных форм. Спирали и месильный крюк из нержавеющей стали AISI 304 - микропереключатель на крышке контейнера - крышка с решеткой для добавления дополнительных компонентов во время обработки - подходящая полностью выдвижная посудомоечная машина. Принадлежности: нож для макаронных изделий - Вставки для лапши различных форм - тележка и коробки со свежими макаронами.

PF15E	
	0,25 kW (0,33 HP)
	220-240V/1N/50Hz
	2 L
	2,5 ÷ 5 Kg/h
	1,5 Kg
	ø 50 mm*
	240 x 525 x 320/450(h) mm
	
	16 Kg
	19 Kg
	280 x 520 x 450(h) mm
	0,065 m³



ACCOLPF15N  
COLTELLO TAGLIA PASTA / PASTA CUTTING KNIFE

OPTIONAL



154

145

PF25E  
PF40E

*Lilly*

New



PF40E



PF25E



Made in  
*Romagna*

\* Trafile escluse.  
Without mould.  
Filières exclues.  
Nudeleinsätze ausgeschlossen.  
Moldes no incluidos.  
Фильера исключен.

Macchina pasta fresca

PASTA MACHINE  
MACHINE À PÂTE  
NUDELMASCHINE  
MÁQUINA PARA PASTA FRESCA  
МАШИНКА ДЛЯ ПРИГОТОВЛЕНИЯ СВЕЖИХ  
МАКАРОННЫХ ИЗДЕЛИЙ

**IT** Macchina per la pasta fresca ideale per impastare ed estrarre impasti in diversi formati. Carcassa, vasca, supporto vasca, gancio impastatore ed elica in acciaio inox AISI 304 - microinterruttore su coperchio vasca - coperchio grigliato per permettere l'inserimento di ingredienti anche durante la lavorazione - pannello di comandi digitale - vasca completamente estraibile per un facile e rapido lavaggio. Il modello PF40E è dotato di bocca di estrusione con raffreddamento ad acqua e coltello taglia pasta incluso. Accessori: coltello tagliapasta per il modello PF25E - trafile in bronzo di diverso tipo - carrello e cassette porta pasta fresca.

**EN** Fresh pasta machine to mix and mould fresh pasta in different shapes. AISI 304 stainless steel casing, bowl, bowl support, kneading hook and blade - micro switch on bowl lid - grilled lid to add extra ingredients during processing - digital control panel - completely extractable bowl dishwasher safe. The PF40E model is equipped with an extrusion outlet with water cooling and a pasta cutting knife included. Accessories: pasta cutter knife for model PF25E - bronze moulds in different shapes - trolley and fresh pasta containers.

**FR** Machine à pâtes fraîches idéale pour pétrir et extruder la pâte en différents formats. Corps, cuve, support de la cuve, crochet pétrisseur et hélice en acier inox AISI 304, microinterrupteur sur le couvercle de la cuve -couvercle grillé pour ajouter les ingrédients pendant la préparation - panneau de commande numérique - cuve entièrement amovible pour un lavage rapide et facile. Le modèle PF40E est équipé d'une orifice d'extrusion refroidie à l'eau et d'un couteau coupe-pâtes. Accessoires: coupe-pâtes pour le modèle PF25E - filières en bronze de différents types - chariot et bacs de pâtes fraîches.

**DE** Frisch-Nudelmaschine, ideal zum Kneten und Extrudieren von Frisch-Nudeln in verschiedenen Formen. Gehäuse, Schüssel, Schüsselhalterung, Knethaken und Spirale aus Edelstahl AISI 304 - Mikroschalter am Schüsseldeckel - Gitterdeckel zum Hinzufügen zusätzlicher Zutaten während der Verarbeitung - digitales Bedienfeld - vollständig ausziehbare Schüssel Geschirrspülmaschine geeignet. Das Modell PF40E ist mit einem Extrusionsauslass mit Wasserkühlung ausgestattet und wird mit einem Nudelschneidmesser geliefert. Zubehör: Nudelschneidmesser für das Modell PF25E - verschiedene Arten von Nudleinsätze - Wagen und Behälter für frische Nudeln.

**ES** Máquina de pasta fresca ideal para mezclar y moldear pasta fresca de diferentes formas. Carcasa, bol, soporte del bol, gancho de amasado y cuchilla de acero inoxidable AISI 304 - microinterruptor en la tapa del bol - tapa con rejilla para añadir ingredientes adicionales durante el proceso - panel de control digital - bol completamente extraíble y apto para lavavajillas. El modelo PF40E está equipado con una salida de extrusión con refrigeración por agua y un cuchillo para pasta incluido. Accesorios: cuchillo para pasta para el modelo PF25E - moldes de bronce de diferentes formas - carrito y cajas por la pasta fresca.

**RU** Макаронная установка для приготовления свежих макарон, идеально подходит для замешивания и экструзии свежих макаронных изделий различных форм. Корпус из нержавеющей стали AISI 304, контейнера, держатель, тестовый крючок и спираль - микропереключатель на крышке контейнера - крышка с решеткой для добавления дополнительных компонентов во время обработки - цифровая панель управления - подходящая полностью выдвижная посудомоечная машина. Модель PF40E оснащена водяным экструзионным выходом и поставляется с резак для макарон. Принадлежности: нож для макаронных изделий для модели PF25E - Вставки для лапши различных форм - тележка и коробки со свежими макаронами.

	PF25E	PF40E
	0,37 kW (0,5 HP)	0,75 kW (1 HP)
	380-415V/3N/50Hz	
	220-240V/1N/50Hz	
	4 L	6 L
	8 Kg/h	13 Kg/h
	2 Kg	3,5 Kg
	ø 57 mm*	
	310 x 550 x 420/540(h) mm	320 x 595 x 530/630(h) mm
		
	27 Kg	35 Kg
	34 Kg	46 Kg
	390 x 650 x 560(h) mm	460 x 700 x 770(h) mm
	0,141 m³	0,250 m³

# MPF1.5N













\* Trafile escluse.  
Without mould.  
Filières exclues.  
Nudeleinsätze ausgeschlossen.  
Moldes no incluidos.  
Фильера исключен.

## Macchina pasta fresca

PASTA MACHINE  
MACHINE À PÂTE  
NUDELMASCHINE  
MÁQUINA PARA PASTA FRESCA  
МАШИНКА ДЛЯ ПРИГОТОВЛЕНИЯ СВЕЖИХ  
МАКАРОННЫХ ИЗДЕЛИЙ

- IT Macchina per impastare ed estrarre impasti all'uovo in diversi formati. Struttura rivestita con vernice antigraffio - **vasca, gancio impastatore ed elica in acciaio inox AISI 304** - microinterruttore su coperchio vasca. Accessori: trafilè in bronzo di diverso tipo - carrello e cassette porta pasta fresca.
- EN Machine to mix and mould egg mixtures pasta in different shapes. Structure coated with scratch-proof paint - **AISI 304 stainless steel bowl, blade and kneader** - micro switch on basin lid. Accessories: bronze moulds in different shapes - trolley and fresh pasta containers.
- FR Machine pour pétrir et extruder la pâte aux oeufs en différents formats. Corps recouvert de peinture anti-rayures - **cuve, hélice et crochet pétrisseur en acier inox AISI 304** - microinterruteur sur le couvercle de la cuve. Accessoires: filières en bronze de différents types - chariot et bacs de pâtes fraîches.
- DE Knet- und Extrudiermaschine für Eimischungen in verschiedenen Formaten. Gehäuse mit kratzfester Lackierung beschichtet - **Schüssel, Spirale und Knehtaken aus Edelstahl AISI 304** - Mikroschalter am Behälterdeckel. Zubehör: verschiedene Arten von Nudleinsätze - Wagen und Behälter für frische Nudeln.
- ES Máquina para amasar y extrudir masas con huevo de diferentes formatos. Estructura recubierta con pintura anti-arañazos - **bol y hélice de aleación, gancho amasador de acero inoxidable AISI 304** - microinterruptor en la tapa del bol. Accesorios: moldes de bronce de diferentes tipos, carro y cajas para pasta fresca.
- RU Тестомес-экструдер для яичных смесей различных форматов. Корпус покрыт устойчивой к царапинам краской - **дежа и месильный крюк из нержавеющей стали AISI304**-микровыключатель на крышке контейнера. Принадлежности: Вставки для лапши различных форм - тележка и коробки со свежими макаронами.

	<b>MPF1.5N</b>
	0,3 kW (0,4 HP)
 1 Ph	230V/1N/50Hz
 Kg/h	5 Kg/h
 Kg	1,5 Kg
	ø 50 mm*
 mm	250 x 480 x 290÷460(h) mm
	
 NET Kg	18 Kg
 GROSS Kg	20 Kg
 mm	320 x 590 x 410(h) mm
 m <sup>3</sup>	0,077 m <sup>3</sup>



# MPF2.5N MPF2.5CN



MPF2.5N



MPF2.5CN

\* Trafile escluse.  
Without mould.  
Filières exclues.  
Nudeleinsätze ausgeschlossen.  
Moldes no incluidos.  
Фильера исключен.

Macchina pasta fresca

PASTA MACHINE  
MACHINE À PÂTE  
NUDELMASCHINE  
MÁQUINA PARA PASTA FRESCA  
МАШИНКА ДЛЯ ПРИГОТОВЛЕНИЯ СВЕЖИХ  
МАКАРОННЫХ ИЗДЕЛИЙ

IT Macchina per impastare ed estrarre impasti all'uovo in diversi formati. Struttura rivestita con vernice antigraffio - **vasca, gancio impastatore ed elica in acciaio inox AISI 304** - microinterruttore su coperchio vasca. Il modello MPF2.5CN include il coltello taglia pasta elettronico nel prezzo. Accessori: trafilare in bronzo di diverso tipo - carrello e cassette porta pasta fresca.



EN Machine to mix and mould egg mixtures pasta in different shapes. Structure coated with scratch-proof paint - **AISI 304 stainless steel bowl, blade and kneader** - micro switch on basin lid. The price of MPF2.5CN model includes the electronic pasta cutter knife. Accessories: bronze moulds in different shapes - trolley and fresh pasta containers.

FR Machine pour pétrir et extruder la pâte aux oeufs en différents formats. Corps recouvert de peinture anti-rayures - **cuve, hélice et crochet pétrisseur en acier inox AISI 304** - microinterruteur sur le couvercle de la cuve. Le prix du modèle MPF2.5CN inclut le couteau coupe-pâtes électronique. Accessoires: filières en bronze de différents types - chariot et bacs de pâtes fraîches.

DE Knet- und Extrudiermaschine für Eimischungen in verschiedenen Formaten. Gehäuse mit kratzfester Lackierung beschichtet - **Schüssel, Spirale und Knehtaken aus Edelstahl AISI 304** - Mikroschalter am Behälterdeckel. Beim Modell MPF2.5CN ist das elektronische Nudelschneidmesser im Preis inbegriffen. Zubehör: verschiedene Arten von Nudleinsätze - Wagen und Behälter für frische Nudeln.

ES Máquina para amasar y extrudir masas con huevo de diferentes formatos. Estructura recubierta con pintura anti-arañazos - **bol y hélice de aleación, gancho amasador de acero inoxidable AISI 304** - microinterruptor en la tapa del bol. Con el modelo MPF2.5CN se incluye en el precio el cuchillo electrónico para cortar pasta. Accesorios: moldes de bronce de diferentes tipos, carro y cajas para pasta fresca.

RU Тестомес-экструдер для яичных смесей различных форматов. Корпус покрыт устойчивой к царапинам краской - **дежа и месильный крюк из нержавеющей стали AISI 304** - микровыключатель на крышке контейнера. В модели MPF2.5CN электронный нож для макаронных изделий включен в цену. Принадлежности: Вставки для лапши различных форм - тележка и коробки со свежими макаронами. Принадлежности: Вставки для лапши различных форм - тележка и коробки со свежими макаронами.

	MPF2.5N	MPF2.5CN
	0,37 kW (0,5 HP)	
 1 Ph	230V/1N/50Hz	
 Kg/h	8 Kg/h	
	2,5 Kg	
	ø 57 mm*	
 mm	260 x 600 x 380÷560(h) mm	
		
 NET Kg	30 Kg	32 Kg
 GROSS Kg	36 Kg	38 Kg
 mm	370 x 720 x 580(h) mm	
 m <sup>3</sup>	0,155 m <sup>3</sup>	

# MPF4N MPF8N



MPF8N



MPF4N

\* Trafile escluse.  
Without mould.  
Filières exclues.  
Nudeleinsätze ausgeschlossen.  
Moldes no incluidos.  
Фильера исключен.

Macchina pasta fresca

PASTA MACHINE  
MACHINE À PÂTE  
NUDELMASCHINE  
MÁQUINA PARA PASTA FRESCA  
МАШИНКА ДЛЯ ПРИГОТОВЛЕНИЯ СВЕЖИХ  
МАКАРОННЫХ ИЗДЕЛИЙ



IT Macchina per impastare ed estrarre impasti all'uovo in diversi formati. Struttura rivestita con vernice antigraffio - **vasca, gancio impastatore ed elica in acciaio inox AISI 304 - elica in lega ottone/bronzo (MPF8N)** - microinterruttore su coperchio vasca - raffreddamento della zona di estrusione ad aria - coltello taglia pasta elettronico di serie. Il modello MPF8N ha il cavalletto di serie. Accessori: trafilè in bronzo di diverso tipo - carrello e cassette porta pasta fresca.

EN Machine to mix and mould egg mixtures in different shapes. Structure coated with scratch-proof paint - **AISI 304 stainless steel bowl, blade and kneader - brass/bronze alloy blade (MPF8N)** - micro switch on bowl lid - air-cooled extrusion area - electronic pasta cutter knife as standard. Model MPF8N is delivered with stand as standard. Accessories: bronze moulds in different shapes - trolley and fresh pasta containers.

FR Machine pour pétrir et extruder la pâte aux oeufs en différents formats. Corps recouvert de peinture anti-rayures - **cuve, hélice et crochet pétrisseur en acier inox AISI 304 - hélice en alliage laiton/bronze (MPF8N)** - microinterrupteur sur le couvercle de la cuve - refroidissement de la partie d'extrusion à l'air et coupe-pâtes électronique de série. Le modèle MPF8N inclut de série le support. Accessoires: filières en bronze de différents types - chariot et bacs de pâtes fraîches.

DE Knet- und Extrudiermaschine für Eimischungen in verschiedenen Formaten. Gehäuse mit kratzfester Lackierung beschichtet - **Wanne, Spirale aus Messing und Kneithaken aus Edelstahl AISI 304 - Spirale aus Messing und Bronzelegierung (MPF8N)** - Mikroschalter am Wannendeckel. Serienausstattung: Luftkühlung des Extrusionsbereichs und elektronischer Nudelschneider. Das Modell MPF8N ist serienmäßig mit einem Stützfuß ausgestattet. Zubehör: verschiedene Arten von Nudleinsätze - Wagen und Behälter für frische Nudeln.

ES Máquina para amasar y extrudir masas con huevo de diferentes formatos. Estructura recubierta con pintura anti-arañazos - **bol y gancho amasador de acero inoxidable AISI 304 - hélice de aleación latón/bronze (MPF8N)** - microinterruptor en la tapa del bol. Refrigeración de la zona de extrusión por aire. Corta pasta electrónico en la dotación. Con el modelo MPF8N se incluye también el trípode. Accesorios: moldes de bronce de diferentes tipos, carro y cajas para pasta fresca.

RU Тестомес-экструдер для яичных смесей различных форматов. Корпус покрыт устойчивой к царапинам краской - **дежа и месильный крюк из нержавеющей стали AISI 304 - спирали из латуни и бронзового сплава (MPF8N)** - микровыключатель на крышке контейнера. Стандартное оснащение: воздушное охлаждение зоны экструзии и электронный нож для макаронных изделий. Модель MPF8N оснащена опорной ножкой. Принадлежности: Вставки для лапши различных форм - тележка и коробки со свежими макаронами.



ACCARMPF  
CAVALLETTO - STAND

	MPF4N	MPF8N
	0,75 kW (1 HP)	1 kW (1,3 HP)
	230-400V/3/50Hz	
	13 Kg/h	25 Kg/h
	4 Kg	8 Kg
	ø 57 mm*	ø 78 mm*
	350 x 760 x 450÷640(h) mm	450 x 720 x 750÷990(h) mm
	42 Kg	87 Kg
	51 Kg	97 Kg
	460 x 740 x 670(h) mm	800 x 1000 x 940(h) mm
	0,228 m³	0,524 m³

	ACCARMPF	
	580 x 440 x 560(h) mm	
	12,2 Kg	13,6 Kg
	640 x 430 x 610(h) mm	0,168 m³

CASERECCHE

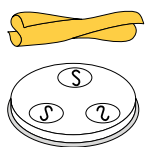

FUSILLI

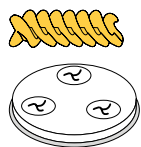

PAPPARDELLE

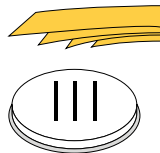

PAPPARDELLE RICCE

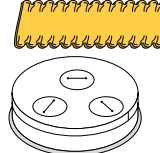

BUCATINI

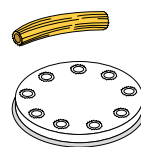

BIGOLI

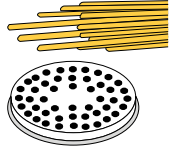

CAPELLI D'ANGELO

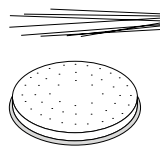

SPAGHETTI

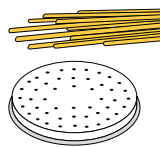

SPAGHETTI ALLA CHITARRA

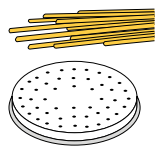

TAGLIOLINI

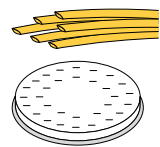

LINGUINE 3x1,6

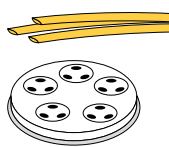

LINGUINE 4x1,6

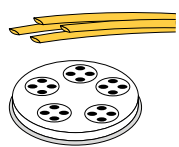

FETTUCCINE

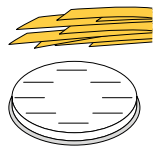

PASTA SFOGLIA

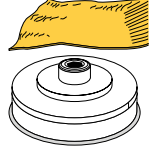

CANNELLONE

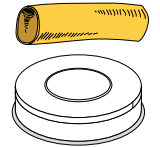

GRAMIGNA

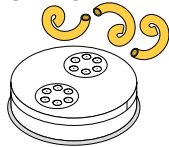
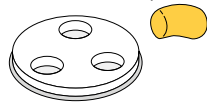
GNOCCHI  
non di patate  
not suitable for potatoes

SENZA FORI

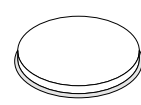

MACCHERONI Ø 4,8



MACCHERONI Ø 8,5

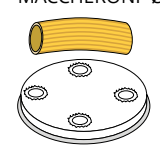

MACCHERONI Ø 15

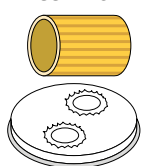

CANESTRINI

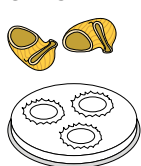

I disegni delle trafile sono indicativi.  
Il numero dei fori cambia in base  
al modello della macchina.

The drawings of the moulds are merely  
illustrative. The number of holes changes  
depending on the machine model.

Les dessins des filières sont donnés à  
titre indicatif. Le nombre de trous varie  
en fonction du modèle de la machine.

Die Abbildungen der Einsätze sind nur  
als Beispiel zu verstehen. Die Anzahl der  
Löcher ändert sich je nach Maschinentyp.

Los gráficos de las moldes son indicativos.  
El número de agujeros varía según  
el modelo de la máquina.

Рисунки вставок следует рассматривать  
только в качестве примера. Число  
отверстий зависит от типа станка.



Trafile  
formati vari in lega ottone-bronzo

ACCESSORIES  
ACCESSOIRES  
ZUBEHÖR  
ACCESORIOS  
AKCECCYAPY

Trafile formati vari in lega ottone-bronzo  
 Brass-bronze alloy mould in different shapes  
 Filières d'étirage de différentes tailles en alliage laiton-bronze  
 Nudleinsätze in verschiedenen Formate aus Messing-Kupferlegierung  
 Moldes de diferentes medidas y tamaños en aleación de latón-bronze  
 Насадки для макаронных изделий для различных форматов из латунно-бронзового сплава

Cadauna - Each - Chacune - Je Stück - Cada uno - Каждая

Mod.	PF15E - MPF1.5N	PF25E - MPF2.5N	PF40E - MPF4N	PF80E - MPF8N
CASERECCO - 9 x 5 mm	ACTRMPF13		ACTRMPF1	ACTRMPF25
FUSILLI - ø 9 mm	ACTRMPF17		ACTRMPF2	ACTRMPF29
PAPPARDELLE - 16 mm	ACTRMPF18		ACTRMPF3	ACTRMPF30
GNOCCHI - ø 12 mm	ACTRMPF19		ACTRMPF4	ACTRMPF31
BUCATINI - ø 4 mm	ACTRMPF20		ACTRMPF5	ACTRMPF32
BIGOLI - ø 3 mm	ACTRMPF43		ACTRMPF41	ACTRMPF44
CAPELLI D'ANGELO - ø 1 mm	ACTRMPF22		ACTRMPF7	ACTRMPF34
SPAGHETTI - ø 2 mm	ACTRMPF23		ACTRMPF8	ACTRMPF35
SPAGHETTI ALLA CHITARRA 2 x 2 mm	ACTRMPF39		ACTRMPF40	ACTRMPF38
TAGLIOLINI - 3 mm	ACTRMPF24		ACTRMPF9	ACTRMPF36
LINGUINE 3 x 1.6 - 3 mm	ACTRMPF49		ACTRMPF50	ACTRMPF51
LINGUINE 4 x 1.6 - 4 mm	ACTRMPF52		ACTRMPF53	ACTRMPF54
FETTUCCINE - 8 mm	ACTRMPF14		ACTRMPF10	ACTRMPF26
GRAMIGNA - ø 3,5 mm	ACTRMPF55		ACTRMPF56	ACTRMPF57
PAPPARDELLE RICCE - 16 mm	ACTRMPF46		ACTRMPF47	ACTRMPF48
MACCHERONI - ø 4,8 mm	ACTRMPF64		ACTRMPF65	ACTRMPF66
MACCHERONI - ø 8,5 mm	ACTRMPF21		ACTRMPF6	ACTRMPF33
MACCHERONI - ø 15 mm	ACTRMPF67		ACTRMPF68	ACTRMPF69
CANESTRINI - ø 16 mm	ACTRMPF70		ACTRMPF71	ACTRMPF72
SENZA FORI	ACTRMPF42		ACTRMPF37	ACTRMPF45
CANNELLONE RIPIENO	ACTRMPF16 ø 25 mm		ACTRMPF12 ø 25 mm	ACTRMPF28 ø 30 mm
PASTA SFOGLIA min. 1 - max 4 mm spessore/thickness	ACTRMPF15 135 mm		ACTRMPF11 155 mm	ACTRMPF27 205 mm

# CARPF

Carrello per cassette porta pasta fresca



Accessori  
Carrello e cassette porta pasta fresca

ACCESSORIES  
ACCESSOIRES  
ZUBEHÖR  
ACCESORIOS  
AKCECCYAPЫ

- IT Carrello in acciaio inox con possibilità di portare fino ad 8 cassette per la pasta fresca di altezza 7 cm - 4 ruote di cui 2 con freno - cassette escluse.
- EN Trolley for fresh pasta containers. Stainless steel trolley for up to 8 7 cm high fresh pasta containers - 4 wheels, 2 of which with brakes - containers not included.
- FR Chariot pour bacs à pâtes fraîches. Chariot en acier inox qui peut porter jusqu'à 8 bacs de pâtes fraîches de 7 cm de hauteur - 4 roues, dont 2 avec freins - Bacs non fournis.
- DE Wagen für frische Nudelbehälter. Wagen aus Edelstahl, Kapazität bis zu 8 frische Nudelbehälter H. 7 cm - 4 Räder, davon 2 mit Bremsen - Behälter nicht inbegriffen.
- ES Carro para cajas de pasta fresca. Carro de acero inoxidable que puede transportar hasta 8 cajas de pasta fresca de 7 cm de altura - 4 ruedas, 2 de ellas con frenos - cajas excluidas.
- RU Тележка для коробок со свежими макаронными изделиями. Тележка из нержавеющей стали, способная перевозить до 8 коробок свежих макарон высотой 7 см - 4 колеса, 2 из которых с тормозами - без учета коробок.

Scopri tutti gli optional su Forcar Multiservice!  
Discover Forcar Multiservice!



CARPF			
	<table border="1"> <tr> <td>APERTO / OPEN 1035 x 520 x 940(h) mm</td> <td>CHIUSO / CLOSED 735 x 520 x 940(h) mm</td> </tr> </table>	APERTO / OPEN 1035 x 520 x 940(h) mm	CHIUSO / CLOSED 735 x 520 x 940(h) mm
APERTO / OPEN 1035 x 520 x 940(h) mm	CHIUSO / CLOSED 735 x 520 x 940(h) mm		
	350 x 445 mm		
	17,5 Kg		
	20,5 Kg		
	900 x 800 x 150(h) mm		
	0,108 m <sup>3</sup>		

## AV6007N

Cassetta porta pasta fresca. Minimo confezione di vendita da 4 pezzi.

Fresh pasta container. 4-piece sales pack.

Bac à pâtes fraîches. Emballage de vente de 4 pièces minimum.

Frische Nudeln Behälter. Mindestverkaufspackung 4 Stück

Caja para pasta fresca. Venta mínima de 4 piezas.

Коробка со свежими макаронами. минимальная торговая упаковка из 4 штук.

AV6007N	
	600 x 400 x 70(h) mm

FI32N  
FI42N  
FIP42N



FI32N



GUARDA IL VIDEO  
WATCH THE VIDEO



FIP42N



FI42N

Stendipizza  
a due coppie di rulli

PIZZA ROLLER MACHINE  
FAÇONNEUSE POUR PIZZA  
PIZZATEIGAUSSROLLMASCHINE  
MÁQUINA PARA EXTENDER  
MASA DE PIZZA CON RODILLOS  
ТЕСТОРАСКАТОЧНАЯ МАШИНА ДЛЯ ПИЦЦЫ



GUARDA IL VIDEO  
WATCH THE VIDEO

**IT** Macchina per stendere impasti di pizza, pane, piada, focacce, ecc. Struttura interamente in acciaio inox AISI 304 - rulli in resina alimentare - leva di regolazione spessore su entrambe i gruppi - apertura rulli da 0,3 mm a max 5,5 mm - rulli superiori inclinati (FI32N-42N) o paralleli (FIP42N) per realizzare diverse forme. Il sistema con micro di sicurezza si trova sul coperchio protezione rulli superiori e permette il funzionamento solo a coperchio chiuso.

**EN** Machine to roll out doughs of pizza, bread, piadina, focaccia, etc.. Structure entirely in stainless steel AISI 304 - food safe resin rollers - lever for thickness adjustment on both groups - roller opening from 0.3 mm to max. 5.5 mm - upper rollers inclined (FI32N-42N) or parallel (FIP42N) to create different forms. The system with safety micro is located on the lid protection of upper rollers and allows operation only when the lid is closed.

**FR** Machine à rouler les pâtes de pizza, pain, piadina, focaccia, etc... Corps entièrement en acier inox AISI 304 - rouleaux en résine alimentaire - levier de réglage de l'épaisseur sur les deux unités - ouverture des rouleaux de 0,3 mm à 5,5 mm maximum - rouleaux supérieurs inclinés (FI32N-42N) ou rouleaux parallèles (FIP42N) pour créer différentes formes. Le système de sécurité avec microinterrupteur est situé sur le couvercle de protection des rouleaux supérieurs et ne permet le fonctionnement que lorsque le couvercle est fermé.

**DE** Maschine zum Ausrollen von Pizza-, Brot-, Piada-, Fladenteig usw. Gehäuse vollständig aus Edelstahl AISI 304 - Rollen aus Lebensmittelharz - Dickenverstellhebel an beiden Einheiten - Rollenöffnungsweite von 0,3 mm bis max. 5,5 mm - obere Rollen geneigt (FI32N-42N) oder parallel (FIP42N) zur Zubereitung verschiedener Formen. Das Mikrosicherheitsystem befindet sich auf dem oberen Rollenschutzdeckel und erlaubt den Betrieb nur bei geschlossenem Deckel.

**ES** Máquina para estirar masas de pizza, pan, tortilla, etc. Estructura completamente de acero inoxidable AISI 304 - rodillos de resina para alimentos - palanca de regulación espesor en ambos grupos - distancia entre rodillos de 0,3 mm a max 5,5 mm - rodillos superiores inclinados (FI32N-42N) o paralelos (FIP42N) para realizar diferentes formas. Sistema con microinterruptor de seguridad, ubicado en la tapa de protección de los rodillos superiores, que permite el funcionamiento sólo con la tapa cerrada.

**RU** Машина для раскатки теста для пиццы, хлеба, пьядины, лепешек и т. д. Корпус полностью из нержавеющей стали AISI 304 - валки из пищевой смолы - рычаг регулировки толщины на обоих узлах - ширина просвета от 0,3 мм до макс. 5,5 мм - верхние валки наклонные (FI32N-42N) или параллельные (FIP42N) для подготовки различных форм. Микросистема безопасности расположена на верхней защитной крышке валков и позволяет работать только при закрытой крышке.

	FI32N	FI42N	FIP42N
	0,37 kW (0,5 HP)		
	230V/1N/50Hz		
	320 mm	420 mm	
	min 0,3 - max 5,5 mm		
	460 x 510 x 630÷700(h) mm	590 x 540 x 760÷820(h) mm	590 x 515 x 700÷770(h) mm
			
	36 Kg	44 Kg	45 Kg
	45 Kg	53 Kg	54 Kg
	680 x 610 x 760(h) mm		
	0,357 m <sup>3</sup>		

FI32N

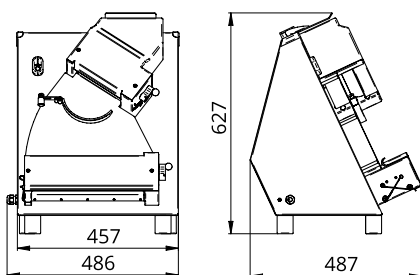

FI42N

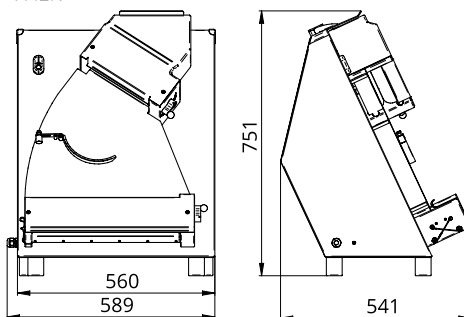

FIP42N

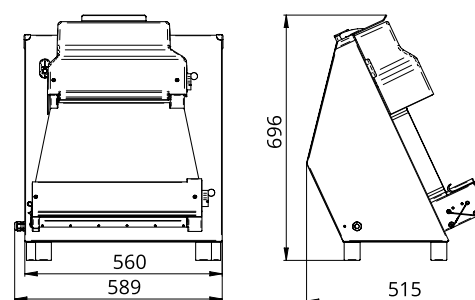

# FIM42N



Made in  
*Romagna*

## Stendipizza monorullo

PIZZA ROLLER MACHINE  
FAÇONNEUSE POUR PIZZA  
PIZZATEIGAUSSROLLMASCHINE  
MÁQUINA PARA EXTENDER MASA  
DE PIZZA CON RODILLOS  
ТЕСТОРАСКАТОЧНАЯ МАШИНА ДЛЯ ПИЦЦЫ



GUARDA IL VIDEO  
WATCH THE VIDEO

 **fimar**



IT Macchina per stendere impasti di pizza, piada, focacce, ecc. Struttura interamente in acciaio inox AISI 304 - singola coppia di rulli in resina alimentare - leva di regolazione spessore. Il sistema con micro di sicurezza si trova sul coperchio protezione rulli superiori e permette il funzionamento solo a coperchio chiuso.

EN Machine to roll out doughs of pizza, bread, piadina, focaccia, etc. Structure entirely in stainless steel AISI 304 - food safe resin rollers - lever for thickness adjustment . The system with safety micro is located on the lid protection of upper rollers and allows operation only when the lid is closed.

FR Machine à rouler les pâtes de pizza, pain, piadina, focaccia, etc. Corps entièrement en acier inox AISI 304 - Paire de rouleaux en résine alimentaire - levier de réglage de l'épaisseur. Le système de sécurité avec microinterrupteur est situé sur le couvercle de protection des rouleaux supérieurs et ne permet le fonctionnement que lorsque le couvercle est fermé.

DE Maschine zum Ausrollen von Pizza, Brot, Piada, Fladenteig usw. Gehäuse vollständig aus Edelstahl AISI 304 - Rollen aus Lebensmittelharz - Dickenverstellhebel. Das Mikrosicherheitssystem befindet sich auf dem oberen Rollenschutzdeckel und erlaubt den Betrieb nur bei geschlossenem Deckel.

ES Máquina para estirar masas de pizza, pan, tortilla, etc. Estructura completamente de acero inoxidable AISI 304 - única pareja de rodillos de resina para alimentos - palanca de regulación espesor. Sistema con microinterruptor de seguridad, ubicado en la tapa de protección de los rodillos superiores, que permite el funcionamiento sólo con la tapa cerrada.

RU Машина для раскатки теста для пиццы, хлеба, пьядины, лепешек и т. д. Корпус полностью из нержавеющей стали AISI 304 - валки из пищевой смолы - рычаг регулировки толщины. Микросистема безопасности расположена на верхней защитной крышке валков и позволяет работать только при закрытой крышке.

FIM42N	
	0,37 kW (0,5 HP)
	230V/1N/50Hz
	420 mm
	min 0,3 - max 5,5 mm
	560 x 410 x 450(h) mm
	
	30 Kg
	38 Kg
	750 x 500 x 450(h) mm
	0,168 m <sup>3</sup>

FIM42N

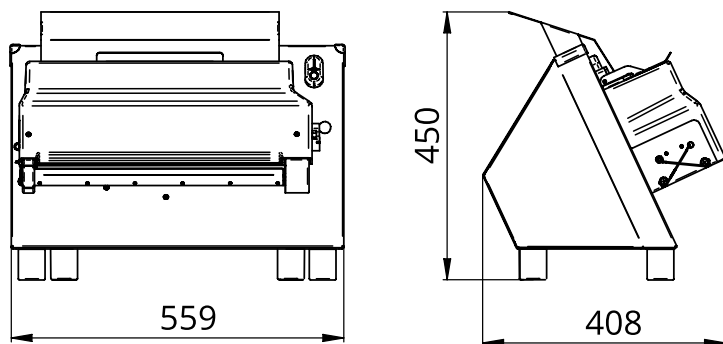

SI320  
SI420  
SI520



SI420



SI420  
OPTIONAL  
TAGLIASFOGLIA  
PASTRY CUTTER

Sfogliatrici stendipizza

PASTA AND PIZZA ROLLER MACHINE  
FAÇONNEUSE POUR PÂTE ET PIZZA  
PIZZA UND TEIGAUSSROLLMASCHINE  
MÁQUINA PARA EXTENDER MASA  
DE PIZZA CON RODILLOS  
ТЕСТОРАСКАТОЧНАЯ МАШИНА ДЛЯ ПИЦЦЫ

**IT** Macchina per stendere impasti all'uovo, pizza e piada. Struttura interamente in acciaio inox AISI 304 - rulli in acciaio inox AISI 304 lucidati a specchio - apertura rulli 0÷10 mm - pomello di regolazione spessore ultimo passaggio - microinterruttore su coperchio di protezione rulli.

Optional: tagliasfoglia singoli - taglio utile 220 mm - diverse misure di taglio da 2-4-6-12 mm.

**EN** Egg, pizza and piadina dough rolling machine. Structure entirely in stainless steel AISI 304 - rollers in stainless steel AISI 304 mirror-polished - roller opening 0÷10 mm - adjustment knob for last passage thickness - microswitch on roller protection lid.

Optional: single sheet cutter - 220 mm useful cut - different cutting sizes 2-4-6-12 mm.

**FR** Machine pour étendre les pâtes aux oeufs, la pizza et piadina. Corps entièrement en acier inox AISI 304 - rouleaux en acier inox AISI 304 polis brillants - ouverture des rouleaux 0÷10 mm - poignée de réglage épaisseur du dernier passage - microinterrupteur sur le couvercle de protection des rouleaux.

Accessoires: coupe-feuilles individuelles - coupe utile 220 mm - différentes tailles de coupe de 2-4-6-12 mm.

**DE** Maschine zum Ausrollen von Eimischungen, Pizza- und Piadateig. Rollen aus Hochglanz-Edelstahl - Rollenöffnungsweite 0÷10 mm - Dicke-Einstellknopf für den letzten Durchgang - Mikroschalter am Schutzdeckel der Rollen.

Auf Wunsch: Einzelblattschneider - 220 mm Nutzschnitt - verschiedene Schnittgrößen: 2-4-6-12 mm.











**ES** Máquina para estirar masas de pizza, pan, tortilla o masas con huevo. Estructura completamente de acero inoxidable AISI 304 - rodillos de acero inoxidable pulido espejo - distancia rodillos 0÷10 mm - perilla de regulación espesor último paso. Microinterruptor ubicado en la tapa de protección de los rodillos. Accesorios: cortadora de hojaldre - sección útil 220 mm - diferentes medidas de corte: 2-4-6-12 mm.







**RU** Машина для раскатывания яичных смесей, теста для пиццы и пьядины. Валки из полированной нержавеющей стали - просвет 0 ÷10 мм. - ручка регулировки толщины для последнего прохода - микропереключатель на защитной крышке валков.

По запросу: нож для нарезки листов - ширина реза 220 мм - различные параметры резания: 2-4-6-12 мм.



Tagliasfoglia.  
Pastry cutter.  
Roulette à pâte.  
Nudelschneidegerät.  
Cortadora de masa.  
Прибор для нарезки тонких слоёв теста.

	SI320	SI420	SI520
	0,37 kW (0,5 HP)		
	230-400V/3/50Hz		
	230V/1N/50Hz		
	320 mm	420 mm	520 mm
	580 x 480 x 400(h) mm	680 x 480 x 400(h) mm	780 x 480 x 400(h) mm
			
	52 Kg	61 Kg	70 Kg
	61 Kg	70 Kg	79 Kg
	770 x 520 x 580(h) mm		
	0,232 m <sup>3</sup>		

	TGP2	TGP4	TGP6	TGP12
	2 mm	4 mm	6 mm	12 mm
	300 x 70 x 55(h) mm			
	3,2 Kg		 3,5 Kg	
	410x165x170(h) mm		 0,014 m <sup>3</sup>	



## Taglio, pelatura e conservazione

CUTTING PEELING  
AND CONSERVATION  
COUPE, PELAGE ET CONSERVATION  
SCHNEIDEN, SCHÄLEN UND LAGERN  
CORTAR, PELAR Y CONSERVAR  
РЕЗКА, ОТСЛАИВАНИЕ И ХРАНЕНИЕ

## IT

Per velocizzare e rendere più semplice il lavoro nella ristorazione professionale sono fondamentali alcuni macchinari come: Tagliaverdure, Tagliamozzarella, Cutter, Pelapatate, Lavacozze, Lavaverdure, Affettatrici e Asciuga Lucida Posate.

Il brand Fimar si è specializzato anche nella conservazione offrendo la possibilità di scelta tra: Macchine Sottovuoto a Campana, a Barra Saldante o Termosigillatrici.

## EN

A few appliances are essential to facilitate and accelerate work in professional catering: Vegetable Cutters, Mozzarella Cutters, Cutters, Potato Peelers, Mussel Washers, Vegetable Washers, Slicers and Polished Cutlery Dryers.

The Fimar brand has also focused on conservation, offering the possibility of choosing between: Vacuum machines, sealing bars or heat sealers.

## FR

Pour accélérer et faciliter le travail dans la restauration professionnelle, quelques machines sont indispensables, telles que: Coupe-légumes, coupe-mozzarella, cutter, éplucheuses de pommes de terre, lave-moules, lave-légumes, tranches et machines à essuyer et polir la vaisselle.

La marque Fimar s'est également spécialisée dans la conservation, en offrant la possibilité de choisir entre: Machines sous-vide, machines à barres de soudure ou thermoscelleuses.

## DE

Um die Arbeit in der professionellen Gastronomie zu beschleunigen und zu erleichtern, sind einige Maschinen unerlässlich, wie zum Beispiel: Gemüseschneider, Mozzarella-Schneider, Schneidegeräte, Kartoffelschäler, Muschelwaschmaschinen, Gemüseschneider, Aufschnittmaschinen und Besteckrockner/-polierer.

Die Firma Fimar hat sich auch auf die Aufbewahrung konzentriert und bietet eine Auswahl an: Vakuumverpacker mit Kammer oder mit Schweißleiste, oder Heißsiegelgeräte.

## ES

Para acelerar y facilitar el trabajo en la hostelería tradicional se necesitan unas máquinas como: cortador de verduras, cortador de mozzarella, cutter, pelapapas, limpiador de mejillones, limpiador de verduras, cortadoras, secadora y pulidora de vajillas.

La marca Fimar se especializó también en la conservación y propone estas soluciones: envasadora al vacío profesional envasadora con barra y selladoras térmicas.

## RU

Для ускорения и облегчения работы в профессиональном кейтеринге необходимо несколько машин, например: Овощерезы, моцарелла, ножницы, ножницы, очистители картофеля, мидии, овощные шайбы, ломтики и сушилки для столовых приборов.

Бренд Fimar также специализируется на консервации, предлагая возможность выбора: Вакуумно-камерные машины, пломбировочные машины или термосклеиватели.

# Mini Mixer

IMMERSION BLENDER

MX20  
MX20V2  
MX20VV

New



MX20

MX20V

MX20V2

250 mm  
Liv. Max. 165 mm

Mini Mixer  
ad immersione

MINI MIXER  
MINI MÉLANGEUR  
MINI-MIXSTAB  
MINI MEZCLADOR  
МИНИ СМЕСИТЕЛЬ

IT Mescolatore realizzato in acciaio inox **AISI 304**, adatto a realizzare minestrone, puree di verdure, salse, pastelle, maionese, passato di pomodoro, pesto ecc. Il modello **MX20** a singola velocità è dotato del solo coltello multiuso; il modello **MX20V2** a 2 velocità è dotato di coltello multiuso ed accessori intercambiabili (affinatore ed emulsionatore); il modello **MX20VV** a velocità variabile è dotato di coltello multiuso ed accessori intercambiabili (affinatore ed emulsionatore).











EN Blending stick made of stainless steel **AISI 304**, ideal for making soups, vegetable purees, sauces, batters, mayonnaise, tomato puree, pesto, etc. The **MX20** single speed model is equipped with a multi-purpose knife only; the **MX20V2** 2 speed model is equipped with a multi-purpose knife and interchangeable accessories (crumbler and emulsifier); the **MX20VV** variable speed model is equipped with a multi-purpose knife and interchangeable accessories (crumbler and emulsifier).

FR Mélangeur en acier inoxydable **AISI 304**, idéal pour la préparation de soupes, purées de légumes, sauces, pâtes, mayonnaise, purée de tomates, pesto, etc. Le modèle **MX20** à une vitesse est équipé uniquement d'un couteau polyvalent; le modèle **MX20V2** à 2 vitesses est équipé d'un couteau polyvalent et d'accessoires interchangeables (broyeur et émulsifieur); le modèle **MX20VV** à vitesse variable est équipé d'un couteau polyvalent et d'accessoires interchangeables (broyeur et émulsifieur).

DE Mixstab aus Edelstahl **AISI 304**, ideal für die Zubereitung von Suppen, Gemüsepurees, Soßen, Teigwaren, Mayonnaise, Tomatenmark, Pesto, etc. Das Modell **MX20** mit einfacher Geschwindigkeit ist nur mit einem Mehrzweckmesser ausgestattet; das Modell **MX20V2** mit 2 Geschwindigkeiten ist mit einem Mehrzweckmesser und austauschbarem Zubehör (Krümler und Emulgator) ausgestattet; das Modell **MX20VV** mit variabler Geschwindigkeit ist mit einem Mehrzweckmesser und austauschbarem Zubehör (Krümler und Emulgator) ausgestattet.

ES Mezclador de acero inoxidable **AISI 304**, ideal para sopas, purés de verduras, salsas, masas, mayonesas, salsa de tomate, pesto, etc. El modelo **MX20** de una velocidad está equipado únicamente con una cuchilla polivalente; el modelo **MX20V2** de 2 velocidades está equipado con una cuchilla polivalente y accesorios intercambiables (refinador y emulsionador); el modelo **MX20VV** de velocidad variable está equipado con una cuchilla polivalente y accesorios intercambiables (refinador y emulsionador).

RU Смеситель изготовлен из нержавеющей стали **AISI 304**, пригоден для приготовления супов, овощных пюре, соусов, блюд, майонеза, томатного пюре, песто и др. Односкоростная модель **MX20** оснащена только универсальным ножом; двухскоростная модель **MX20V2** оснащена универсальным ножом и сменными насадками (гомогенизатор и эмульгатор); модель **MX20VV** с переменной скоростью оснащена универсальным ножом и сменными насадками (гомогенизатор и эмульгатор).

	MX20	MX20V2	MX20VV
	0,2 kW (0,5 HP)		
 1 Ph	230V/1N/50-60Hz		
	13.000 rpm 0,2 Kg - 250(h) mm	6.000/13.000 rpm 2 <sup>nd</sup> speed 0,2 Kg - 250(h) mm	6.000÷13.000 rpm 0,2 Kg - 250(h) mm
	15 L		
	107 x 72 x 499(h) mm (con mescolatore / with mixer)		
			
 NET Kg	1,16 Kg		
 GROSS Kg	2 Kg		
 mm	370 x 270 x 120(h) mm		
 m <sup>3</sup>	0.011 m <sup>3</sup>		

# MX25



## Mixer ad immersione

IMMERSION BLENDER  
MÉLANGEUR À IMMERSION  
EINTAUCH-MIXSTAB  
TRITURADORA A INMERSIÓN  
ПОГРУЖНОЙ БЛЕНДЕР



IT Macchina per ottenere diversi prodotti in base all'utensile utilizzato. Mescolatore realizzato interamente in acciaio inox AISI 304, utile per realizzare minestrone, puree di verdure, salse, pastelle, maionese, passato di pomodoro, pesto ecc... **Il modello MX25 è dotato del solo mescolatore da 30 cm per un livello max di immersione fino a 19 cm.** Possibilità di acquisto del solo blocco motore.













EN Machine for obtaining different mixtures according to the tool used. Blending stick made entirely of stainless steel AISI 304, ideal for making soups, vegetable purees, sauces, batters, mayonnaise, tomato puree, pesto, etc... **he MX25 model is equipped with only a 30 cm blending stick for a maximum immersion level of up to 19 cm.** You can purchase only the motor unit.

FR Machine pour obtenir différents mélanges en fonction de l'outil utilisé. Mélangeur entièrement en acier inoxydable AISI 304, idéal pour la préparation de soupes, purées de légumes, sauces, batters, mayonnaise, purée de tomates, pesto, etc... **Le modèle MX25 est équipé seulement d'un mélangeur de 30 cm pour un niveau d'immersion maximum jusqu'à 19 cm.** Il est possible d'acheter uniquement le groupe moteur.

DE Maschine zur Zubereitung verschiedener Mischungen je nach verwendetem Werkzeug. Mixstab komplett aus Edelstahl AISI 304, ideal für die Zubereitung von Suppen, Gemüsepürees, Saucen, Teigwaren, Mayonnaise, Tomatenmark, Pesto, etc... **Das Modell MX25 ist mit nur einem 30 cm Mixstab für eine maximale Eintauchtiefe von bis zu 19 cm ausgestattet.** Auf Wunsch können Sie nur die Motoreinheit kaufen.

ES Máquina para obtener diferentes productos según el tipo de herramienta que se utiliza. Mezclador de acero inoxidable AISI 304, ideal para sopas, purés de verduras, salsas, masas, mayonesas, salsa de tomate, pesto, etc... **El modelo MX25 solo tiene un mezclador de 30 cm para una inmersión máxima de 19 cm.** Se puede comprar sólo el bloque del motor.

RU Машина для получения различных смесей в зависимости от используемого инструмента. Смеситель, полностью изготовленный из нержавеющей стали AISI 304, идеально подходит для приготовления супов, овощных пюре, соусов, блюд, майонеза, томатного пюре, песто и т.д... **Модель MX25 оснащена смесителем толщиной всего 30 см для максимального погружения до 19 см.** Вы можете приобрести только моторный блок.

i		MX25	
		0,25 kW (0,3 HP)	
		230V/1N/50-60Hz	
		13000 rpm	 0,6 Kg - 300 mm
		30 L	
		135 x 100 x 600(h) mm	
			
		2,2 Kg	
		3,4 Kg	
		410 x 280 x 170(h) mm	
		0,020 m³	

# MX40



## Mixer ad immersione

IMMERSION BLENDER  
MÉLANGEUR À IMMERSION  
EINTAUCH-MIXSTAB  
TRITURADORA A INMERSIÓN  
ПОГРУЖНОЙ БЛЕНДЕР

170



GUARDA IL VIDEO  
WATCH THE VIDEO

 **fimar**

IT Macchina completa di mescolatore più frusta con variatore di velocità per ottenere diversi prodotti in base all'utensile utilizzato. Mescolatore realizzato interamente in acciaio inox AISI 304, utile per realizzare minestrone, puree di verdure, salse, pastelle, maionese, passato di pomodoro, pesto ecc...Frusta realizzata in acciaio inox AISI 304, utile per ottenere panna montata, creme, omelette, soufflé, ecc...**Il modello MX40 è dotato di mescolatore di serie da 40 cm di lunghezza per un livello max di immersione fino a 29 cm e di una frusta di 35 cm con un livello max di immersione fino a 20 cm ed un blocco motore con variatore di velocità.**









EN Machine fitted with mixer and whisk with speed regulator for obtaining different mixtures according to the tool used. Blending stick made entirely of stainless steel AISI 304, ideal for making soups, vegetable purees, sauces, batters, mayonnaise, tomato puree, pesto, etc...Whisk made entirely of stainless steel AISI 304, ideal for making whipped cream, creams, omelets, soufflés, etc...**The model MX40 is equipped with a standard blending stick 40 cm long for a maximum immersion level of up to 29 cm and a whisk of 35 cm with a level of max. immersion up to 20 cm and a motor unit with speed regulator.**

FR Machine équipée d'un mélangeur et d'un fouet avec régulateur de vitesse pour obtenir différents mélanges en fonction de l'outil utilisé. Mélangeur entièrement en acier inoxydable AISI 304, idéal pour la préparation de soupes, purées de légumes, sauces, pâtes, mayonnaise, purée de tomates, pesto, etc...Fouet entièrement en acier inoxydable AISI 304, idéal pour la préparation de crème fouettée, crèmes, omelettes, soufflés, etc...**Le modèle MX40 est équipé d'un mélangeur standard de 40 cm de longueur pour une immersion maximale de 29 cm et d'un fouet de 35 cm avec une immersion maximale de 20 cm et d'un groupe moteur avec régulateur de vitesse.**

DE Maschine mit Mixstab und Schneebesen mit Drehzahlregler zur Zubereitung verschiedener Mischungen je nach verwendetem Werkzeug. Mixstab komplett aus Edelstahl AISI 304, ideal für die Zubereitung von Suppen, Gemüsepurees, Soßen, Teigwaren, Mayonnaise, Tomatenmark, Pesto, etc...Schneebesen komplett aus Edelstahl AISI 304, ideal für die Zubereitung von Schlagsahne, Kremen, Omeletts, Soufflés, etc...**Das Modell MX40 ist ausgestattet mit einem Standard-Mixstab 40 cm Lang für einen maximalen Eintauchtiefe von bis zu 29 cm und einem Schneebesen von 35 cm mit einem maximalen Eintauchtiefe von bis zu 20 cm und einer Motoreinheit mit Drehzahlregler.**

ES Máquina completa de mezclador y batidor con variador de la velocidad para obtener diferentes productos según el tipo de herramienta que se utiliza. Mezclador de acero inoxidable AISI 304, ideal para sopas, purés de verduras, salsas, masas, mayonesas, salsa de tomate, pesto, etc...Batidor de acero inoxidable AISI 304, ideal para cremas, nata, tortillas, soufflé, etc...**El modelo MX40 tiene un mezclador largo 40 cm para una inmersión máxima de 29 cm., y un batidor de 35 cm con una inmersión hasta 20 cm. También tiene el bloque del motor con variador de velocidad.**

RU Машина в комплекте со смесителем и хлыстом с вариатором скорости для получения различных продуктов в зависимости от используемого инструмента. Смеситель полностью изготовлен из нержавеющей стали AISI 304, пригоден для приготовления супов, овощных пюре, соусов, блюд, майонеза, томатного пюре, песто и др...Кнут из нержавеющей стали AISI 304, полезен для получения взбитых сливок, сливок, омлетов, суфле и др...**Модель MX40 оснащена стандартным смесителем длиной 40 см для максимального уровня погружения до 29 см и хлыстом длиной 35 см с максимальным уровнем погружения до 20 см и моторным блоком с вариатором скорости.**

i		MX40	
		0,4 kW (0,5 HP)	
	1 Ph	230V/1N/50-60Hz	
	 RPM	2500÷11000 rpm	 1,4 Kg - 400 mm
	 RPM	250÷1500 rpm	 1 Kg - 350 mm
		60 L	
	mm	155 x 120 x 710/790(h) mm (con frusta/mescolatore - with whisk/mixer)	
			
	NET Kg	4,5 Kg	
	GROSS Kg	6 Kg	
	mm	490 x 390 x 170(h) mm	
	m <sup>3</sup>	0,032 m <sup>3</sup>	

# FX40



## Mixer ad immersione

IMMERSION BLENDER  
MÉLANGEUR À IMMERSION  
EINTAUCH-MIXSTAB  
TRITURADORA A INMERSIÓN  
ПОГРУЖНОЙ БЛЕНДЕР

IT Macchina con impugnatura ergonomica per un'ottima presa senza fatica, completa di mescolatore più frusta con variatore di velocità per ottenere diversi prodotti in base all'utensile utilizzato. Mescolatore realizzato interamente in acciaio inox AISI 304, utile per realizzare minestrone, puree di verdure, salse, pastelle, maionese, passato di pomodoro, pesto ecc...Frusta realizzata in acciaio inox AISI 304, utile per ottenere panna montata, creme, omelette, soufflé, ecc...**Il modello FX40 è dotato di: mescolatore di serie da 40 cm di lunghezza per un livello max di immersione fino a 29 cm, di una frusta di 35 cm di lunghezza per un livello max di immersione fino a 20 cm e di un blocco motore con variatore di velocità.**

EN Machine with ergonomic handle for a good and effortless holding fitted with mixer and whisk with speed regulator for obtaining different mixtures according to the tool used. Blending stick made entirely of stainless steel AISI 304, ideal for making soups, vegetable purees, sauces, batters, mayonnaise, tomato puree, pesto, etc... Whisk made of stainless steel AISI 304, ideal for making whipped cream, creams, omelets, soufflés, etc...**The model FX40 is equipped with a standard blending stick 40 cm long for a maximum immersion level of up to 29 cm and a whisk of 35 cm with a level of max. immersion up to 20 cm and a motor unit with speed regulator.**

FR Machine avec poignée ergonomique pour une bonne et aisée tenue en main équipée d'un mélangeur et d'un fouet avec régulateur de vitesse pour obtenir différents mélanges en fonction de l'outil utilisé. Mélangeur entièrement en acier inoxydable AISI 304, idéal pour la préparation de soupes, purées de légumes, sauces, pâtes, mayonnaise, purée de tomates, pesto, etc...Fouet en acier inox AISI 304, idéal pour la préparation de crème fouettée, crèmes, omelettes, soufflés, etc...**Le modèle FX40 est équipé d'un mélangeur standard de 40 cm de longueur pour une immersion maximale de 29 cm et d'un fouet de 35 cm avec une immersion maximale de 20 cm et d'un groupe moteur avec régulateur de vitesse.**

DE Maschine mit ergonomischem Griff für einen guten und mühelosen Haltekomfort mit Mixstab und Schneebesen mit Drehzahlregler zur Zubereitung verschiedener Mischungen je nach verwendetem Werkzeug. Mixstab komplett aus Edelstahl AISI 304, ideal für die Zubereitung von Suppen, Gemüsepürees, Soßen, Teigwaren, Mayonnaise, Tomatenmark, Pesto, usw...Schneebesen aus Edelstahl AISI 304, ideal für die Zubereitung von Schlagsahne, Kremen, Omeletts, Soufflés, usw...**Das Modell FX40 ist ausgestattet mit einem Standard-Mixstab 40 cm Lang für eine maximale Eintauchtiefe von bis zu 29 cm und einem Schneebesen von 35 cm mit einer maximalen Eintauchtiefe von bis zu 20 cm und einer Motoreinheit mit Drehzahlregler.**

ES Máquina con empuñadura ergonómica para una buena agarrada, completa de mezclador y batidor con variador de la velocidad para obtener diferentes productos según el tipo de herramienta que se utiliza. Mezclador de acero inoxidable AISI 304, ideal para sopas, purés de verduras, salsas, masas, mayonesas, salsa de tomate, pesto, etc...Batidor de acero inoxidable AISI 304, ideal para cremas, nata, tortillas, soufflé, etc...**El modelo FX40 tiene un mezclador largo 40 cm para una inmersión máxima de 29 cm., y un batidor de 35 cm con una inmersión hasta 20 cm. También tiene el bloque del motor con variador de velocidad.**





RU Машина с эргономичной ручкой для хорошего и легкого удержания в руках в комплекте со смесителем и хлыстом с вариатором скорости для получения различных продуктов в зависимости от используемого инструмента. Смеситель полностью изготовлен из нержавеющей стали AISI 304, пригоден для приготовления супов, овощных пюре, соусов, блюд, майонеза, томатного пюре, песто и др... Кнут из нержавеющей стали AISI 304, полезен для получения взбитых сливок, сливок, омлетов, суфле и др...**Модель FX40 оснащена стандартным смесителем длиной 40 см для максимального уровня погружения до 29 см и хлыстом длиной 35 см с максимальным уровнем погружения до 20 см и моторным блоком с вариатором скорости.**

	<b>FX40</b>	
	0,4 kW (0,5 HP)	
	230V/1N/50-60Hz	
	 2500±11000 rpm	 1,4 Kg - 400 mm
	 250±1500 rpm	 1 Kg - 350 mm
	60 L	
	170 x 120 x 660/740(h) mm (con frusta/mescolatore - with whisk/mixer)	
		
	4,5 Kg	
	6 Kg	
	490 x 390 x 170(h) mm	
	0,032 m <sup>3</sup>	

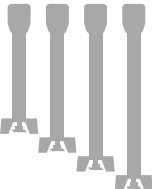

# Optional mixer ad immersione

ACCESSORIES  
ACCESSOIRES  
ZUBEHÖR  
ACCESORIOS  
AKCECCYAPЫ

	Mod.	MX20	MX20V2 MX20VV	MX25	MX40	FX40	mm	Kg	mm
	ME2020	✓	✓	-	-	-	200 mm	0,2 Kg	max. 165 mm
	ME2530	-	-	✓	-	-	300 mm	1,2 Kg	max. 190 mm
	ME4030	-	-	-	✓	✓	300 mm	1,2 Kg	max. 190 mm
	ME4040	-	-	-	✓	✓	400 mm	1,4 Kg	max. 290 mm
	ME4050	-	-	-	✓	✓	500 mm	1,6 Kg	max. 390 mm
	ME4060	-	-	-	✓	✓	600 mm	1,8 Kg	max. 490 mm
	FRUSTAFM3	-	-	-	✓	✓	350 mm	1 Kg	max. 200 mm



# TV4000 L'ORTOLANA



Tagliaverdura

VEGETABLE CUTTER  
COUPE-LÉGUMES  
GEMÜSESCHNEIDER  
CORTADORAS DE HORTALIZAS  
ОВОЩЕРЕЗКА



GUARDA IL VIDEO  
WATCH THE VIDEO

 **fimar**



IT Macchina per tagliare, affettare e grattugiare.  
TV4000 chiamato "L'ortolana": carcassa, bocca e contenitore di raccolta in acciaio inox AISI 304 - microinterruttori di sicurezza su maniglia, bocca e contenitore - doppia bocca inserimento prodotto - bocca ovale ~ 150x70 mm - bocca tonda ø 56 mm. Il prodotto lavorato cade direttamente nel contenitore di raccolta senza utilizzare il disco espulsore lasciandone inalterata l'integrità.













EN Cutting, slicing and gratin machine.  
TV4000 "L'ortolana": casing, inlet and collection container made of stainless steel AISI 304 - safety microswitches on handle, inlet and container - double inlet for product insertion - oval inlet ~ 150x70 mm - round inlet ø 56 mm. The processed product falls directly into the collection container with no need to use the ejector disc, preserving the integrity of the product.

FR Machine à découper, trancher et à râper.  
TV4000 "L'ortolana": corps, orifice d'entrée et cuve de collecte en acier Inox AISI 304 - micro-interrupteurs de sécurité sur la poignée, l'orifice d'entrée et la cuve - double entrée pour insertion produit - ouverture ovale ~ 150x70 mm - ouverture ronde ø 56 mm. Le produit traité tombe directement dans le récipient de collecte sans qu'il soit nécessaire d'utiliser le disque d'éjection, préservant ainsi l'intégrité du produit.

DE Maschine zum Schneiden und Reiben.  
TV4000 "L'ortolana": Gehäuse, Einführöffnung und Auffangbehälter aus Edelstahl AISI 304 - Sicherheitsmikroschalter an Griff, Einführöffnung und Behälter - doppelter Einführöffnung für Produkteinführung - ovale Einführöffnung ~ 150x70 mm - runde Einführöffnung ø 56 mm. Das verarbeitete Produkt fällt direkt in den Sammelbehälter, ohne dass die Auswurfscheibe verwendet werden muss, wodurch die Integrität des Produkts erhalten bleibt.

ES Máquina para cortar, rebanar y rallar.  
TV4000 - "L'ortolana": carcasa, boca y contenedor de recogida de acero inoxidable AISI 304 - microinterruptores de seguridad en la manija, boca y contenedor - boca ovalada ~ 150x70 mm - boca redonda ø 56 mm. El producto elaborado cae directamente en el contenedor sin utilizar el disco expulsor, dejando el producto intacto e inalterado.

RU Машина для резки, склеивания и гратирования.  
TV4000 "L'ortolana": корпус, входная и приемная ёмкость из нержавеющей стали AISI 304 - микровыключатели безопасности на ручке, входе и контейнере - двойной вход для вставки продукта - овальный вход ~ 150x70 мм - круглый вход ø 56 мм. Обработанный продукт попадает непосредственно в приемную емкость без необходимости использования выталкивающего диска, сохраняя целостность продукта.

	<b>TV4000</b>
	0,37 kW (0,5 HP)
	230-400V/3-3N/50Hz
	230V/1N/50Hz
	310 rpm
	ø 240 x 165(h) mm - 7,40 L
	280 x 630 x 550(h) mm
	
	27 Kg
	34 Kg
	370 x 670 x 630(h) mm
	0,156 m³

# TV2000RN LA ROMAGNOLA



Tagliaverdura  
con bocca estraibile

VEGETABLE CUTTER  
COUPE-LÉGUMES  
GEMÜSESCHNEIDER  
CORTADORAS DE HORTALIZAS  
ОВОЩЕРЕЗКА

178



GUARDA IL VIDEO  
WATCH THE VIDEO

 **fimar**

**IT** Macchina per tagliare, affettare frutta, ortaggi, verdure in varie forme e misure, grattugiare formaggio, pane secco, nocchie, sfilacciare carote, sedano, patate, mele, rape, barbabietole, mozzarella.  
TV2000RN chiamato "La Romagnola": presente da oltre 30 anni sui mercati internazionali, ancora più funzionale e versatile. Carcassa e bocca removibile in acciaio inox AISI 304 - microinterruttore di sicurezza su maniglia e bocca - doppia bocca inserimento prodotto - dimensione bocca ovale ~ 155x75 mm - dimensione bocca tonda ø 56 mm.













**EN** Machine for cutting, slicing fruit and vegetables in various shapes and sizes, grating cheese, dry bread, hazelnuts, shredding carrots, celery, potatoes, apples, turnips, beets, mozzarella.  
TV2000RN - La Romagnola: with over 30 years of history on international markets, even more functional and versatile. Removable stainless steel AISI 304 casing and inlet - safety microswitch on handle and inlet - double inlet for product insertion - oval inlet size ~ 155x75 mm - round inlet size ø 56 mm.

**FR** Machine pour couper, trancher des fruits et légumes de différentes formes et tailles, râper du fromage, du pain sec, des noisettes, effilocheur des carottes, céleri, pommes de terre, pommes, navets, betteraves, mozzarella.  
TV2000RN - La Romagnola: avec plus de 30 ans d'histoire sur les marchés internationaux, encore plus fonctionnelle et versatile. Corps et orifice d'entrée amovibles en acier Inox AISI 304 - micro-interrupteur de sécurité sur la poignée et l'orifice d'entrée - double orifice d'entrée pour l'insertion du produit - dimensions du orifice d'entrée oval ~ 155x75 mm- orifice rond ø 56 mm.

**DE** Maschine zum Zerkleinern und Schneiden von Obst und Gemüse in verschiedenen Formen und Größen, Reiben von Käse, trockenem Brot, Haselnüssen, Zerkleinern von Karotten, Sellerie, Kartoffeln, Äpfeln, Rüben, Rote Beete, Mozzarella.  
TV2000RN - La Romagnola: seit über 30 Jahren auf internationalen Märkten bekannt, jetzt noch leistungsfähiger und vielseitiger. Abnehmbares Gehäuse und Einführöffnung aus Edelstahl AISI 304 - Sicherheitsmikroschalter an Griff und Einführöffnung - doppelte Einführöffnung für Produkteinführung - ovale Einführöffnungsgröße ~ 155x75 mm- runde Einführöffnungsgröße ø 56 mm.

**ES** Máquina para cortar, rebanar frutas, hortalizas, verduras de diferentes formas y medidas, rallar queso, pan seco, avellanas, cortar en tiras zanahorias, apio, patatas, manzanas, nabos, remolachas, mozzarella.  
TV2000RN La Romagnola: Restyling de la cortadora de verdura TV2000 "La Romagnola", un modelo que desde hace 30 años tiene mucho éxito en el mercado internacional. Carcasa y boca extraíble de acero inoxidable AISI 304 - microinterruptor de seguridad en la manija y en la boca - boca doble para la introducción del producto. Dimensión boca ovalada ~ 155x75 mm- dimensión boca redonda ø 56 mm.

**RU** Машина для нарезки, измельчения фруктов и овощей различных форм и размеров, нарезания сыра, сухого хлеба, лесных орехов, моркови, сельдерея, картофеля, яблок, репы, свеклы, моцареллы.  
TV2000RN - La Romagnola: с более чем 30-летней историей на международных рынках, еще более функциональный и универсальный. Съёмный корпус и вход из нержавеющей стали AISI 304 - безопасный микровыключатель на ручке и входе - двойной вход для ввода продукта - овальный размер входа ~ 155x75 мм - круглый размер входа ø 56 мм.

	<b>TV2000RN</b>
	0,37 kW (0,5 HP)
	230-400V/3/50Hz
	230V/1N/50Hz
	255 rpm
	220 x 610 x 520(h) mm
	
	
	22 Kg
	24 Kg
	300 x 620 x 580(h) mm
	0,108 m³

# TV3000N



## Tagliaverdura

VEGETABLE CUTTER  
COUPE-LÉGUMES  
GEMÜSESCHNEIDER  
CORTADORAS DE HORTALIZAS  
ОВОЩЕРЕЗКА

IT Macchina per tagliare, affettare frutta, ortaggi, verdure in varie forme e misure, grattugiare formaggio, pane secco, nocciole, sfilacciare carote, sedano, patate, mele, rape, barbabietole, mozzarella.  
TV3000N è dotato di carcassa e bocca in acciaio inox AISI 430 - microinterruttore di sicurezza su maniglia - doppia bocca inserimento prodotto. Dimensioni bocca ovale ~ 155x75 mm, dimensioni bocca tonda ø 56 mm.











EN Machine for cutting, slicing fruit and vegetables in various shapes and sizes, grating cheese, dry bread, hazelnuts, shredding carrots, celery, potatoes, apples, turnips, beets, mozzarella.  
TV3000N with casing and inlet in stainless steel AISI 430 - safety microswitch on handle - double inlet for product insertion. Oval inlet size ~ 155x75 mm - round inlet size ø 56 mm.

FR Machine pour couper, trancher des fruits et légumes de différentes formes et tailles, râper du fromage, du pain sec, des noisettes, effilocheur des carottes, céleri, pommes de terre, pommes, navets, betteraves, mozzarella.  
Le TV3000N est équipé de corps et orifice d'entrée en acier Inox AISI 430 - micro-interrupteur de sécurité sur la poignée - double orifice d'entrée pour l'insertion du produit. Dimensions orifice d'entrée oval ~ 155x75 mm - orifice rond ø 56 mm.

DE Maschine zum Zerkleinern und Schneiden von Obst und Gemüse in verschiedenen Formen und Größen, Reiben von Käse, trockenem Brot, Haselnüssen, Zerkleinern von Karotten, Sellerie, Kartoffeln, Äpfeln, Rüben, Rote Beete, Mozzarella.  
TV3000N wird mit Gehäuse und Einführöffnung aus Edelstahl AISI 430 geliefert - Sicherheitsmikroschalter am Griff - doppelte Einführöffnung für Produkteinführung. Ovale Einführöffnungsgröße ~ 155x75 mm - runde Einführöffnungsgröße ø 56 mm.

ES Máquina para cortar, rebanar frutas, hortalizas, verduras de diferentes formas y medidas, rallar queso, pan seco, avellanas, cortar en tiras zanahorias, apio, patatas, manzanas, nabos, remolachas, mozzarella.  
TV3000N: Carcasa y boca de acero inoxidable AISI 430 - microinterruptor de seguridad en la manija - boca doble para la introducción del producto. Dimensión boca ovalada ~ 155x75 mm - dimensión boca redonda ø 56 mm.

RU Машина для нарезки, измельчения фруктов и овощей различных форм и размеров, нарезания сыра, сухого хлеба, лесных орехов, моркови, сельдерея, картофеля, яблок, репы, свеклы, моцареллы.  
TV3000N поставляется с корпусом из нержавеющей стали AISI 430 и вставным отверстием - Микровыключатель безопасности на ручке - Двойное вставное отверстие для вставки продукта. Овальное установочное отверстие ~ 155x75 мм - Размер круглого установочного отверстия ø 56 мм.

	<b>TV3000N</b>
	0,37 kW (0,5 HP)
	230-400V/3/50Hz
	
	230V/1N/50Hz
	255 rpm
	220 x 610 x 520(h) mm
	
	22 Kg
	24 Kg
	300 x 620 x 580(h) mm
	0,108 m³

# TV2500



## Tagliaverdura

VEGETABLE CUTTER  
COUPE-LÉGUMES  
GEMÜSESCHNEIDER  
CORTADORAS DE HORTALIZAS  
ОВОЩЕПЕЗКА

**IT** Macchina per tagliare, affettare, grattugiare e sfilacciare: frutta, ortaggi, formaggi, mozzarelle, patate, nocciole e tanto altro.  
TV2500 è dotato di carcassa rivestita con vernice poliuretanica antigraffio - bocca in materiale plastico idoneo al contatto con gli alimenti - microinterruttore di sicurezza su maniglia - doppia bocca inserimento prodotto - dimensioni bocca ovale ~ 155x75 mm - dimensioni bocca tonda ø 56 mm.

**EN** Machine for cutting, slicing, grinding and shredding: fruit, vegetables, cheese, mozzarella, potatoes, hazelnuts and much more.  
TV2500 is supplied with a casing coated with anti-scratch polyurethane paint - plastic inlet suitable for food contact - safety microswitch on handle - double inlet for product insertion - oval inlet size ~ 155x75 mm - round inlet size ø 56 mm.

**FR** Machine pour couper, trancher, râper et effiloche: fruits, légumes, fromage, mozzarella, pommes de terre, noisettes et bien plus encore.  
TV2500 est livré avec un corps revêtu d'une peinture polyuréthane anti-rayures - orifice d'entrée en matière plastique pour les produits alimentaires - microrupteur de sécurité sur la poignée - double orifice d'entrée pour l'insertion du produit - orifice d'entrée oval ~ 155x75 mm - orifice rond ø 56 mm.

**DE** Maschine zum Schneiden, Reiben und Zerkleinern von: Obst, Gemüse, Käse, Mozzarella, Kartoffeln, Haselnüsse und vieles mehr.  
TV2500 wird mit einem mit kratzfester Polyurethanfarbe beschichteten Gehäuse geliefert - Kunststoffeinführöffnung lebensmitteltauglich - Sicherheitsmikroschalter am Griff - doppelte Einführöffnung für Produkteinführung. Ovale Einführöffnungsgröße ~ 155x75 mm - runde Einführöffnungsgröße ø 56 mm.

**ES** Máquina para cortar, rebanar frutas, hortalizas, verduras de diferentes formas y medidas, rallar queso, pan seco, avellanas, cortar en tiras zanahorias, apio, patatas, manzanas, nabos, remolachas, mozzarella.  
TV2500: Carcasa revestida con pintura poliuretánica antirayado - boca de material plástico idóneo para el contacto con los alimentos - microinterruptor de seguridad en la manija - boca doble para la introducción del producto - dimensión boca ovalada ~ 155x75 mm - dimensión boca redonda ø 56 mm.

**RU** Машина для резки, натирания и измельчения: Фрукты, овощи, сыр, моцарелла, картофель, лесные орехи и многое другое.  
TV2500 поставляется с корпусом, покрытым стойкой к царапинам полиуретановой краской - пластиковое отверстие для подачи продукта - безопасный микровыключатель на ручке - двойное отверстие для подачи продукта. Размер овального вставного отверстия ~ 155x75 мм - Размер круглого вставного отверстия ø 56 мм.

	<b>TV2500</b>
	0,37 kW (0,5 HP)
 1 Ph	230V/1N/50Hz
 RPM	255 rpm
 mm	220 x 610 x 520(h) mm
	
 NET Kg	22 Kg
 GROSS Kg	24 Kg
 mm	300 x 620 x 580(h) mm
 m <sup>3</sup>	0,108 m <sup>3</sup>



TV4000 - "L'ORTOLANA"



TV2000RN - "LA ROMAGNOLA"



TV3000N



TV2500

Optional  
dischi tagliaverdure

ACCESSORIES  
ACCESSOIRES  
ZUBEHÖR  
ACCESORIOS  
AKCECCYAPBI



## IT DISCHI PER AFFETTARE

E1 - A2 - S1 - S2: Patate chips, rape, cavoli, cetrioli, carote bollite, cipolle, funghi.

E3: mele, banane, patate, zucchine, melanzane, finocchi, carciofi.

E4 - E6: barbabietole, patate, cavoli, rape, cipolle.

E5: pomodori, limoni, arance, mele, ananas, pompelmi.

E8 - E10 - E14: carote bollite, patate, melanzane, barbabietole.

## DISCHI PER SFILACCIARE/GRATTUGIARE

Z2 - Z3: carote, sedano, patate, mele, rape.

Z4: barbabietole, radici, formaggio tipo groviera.

V: parmigiano, pane secco, mandorle, noci, nocciole.

Z7: mozzarella.

## DISCHI PER TAGLIO A CUBETTI

La combinazione dei dischi D8x8 - D10x10 - D12x12 - D20x20 - K8x8 - K10x10 - K12x12 - K20x20 con i dischi E6 - E8 - E10 - E14 permette di ottenere una vastissima serie di cubetti per minestrone e macedonie.

## DISCHI PER TAGLIO A FIAMMIFERO

H2,5 - H4 - H6 - H8 - H10: sedano, zucchine, barbabietole, radici, patate, rape.

La combinazione dei dischi B6 - B8 - B10 con i dischi E6 - E8 - E10 permette di ottenere fiammiferi per tutta la lunghezza del prodotto con lo spessore desiderato.

## EN SLICING DISCS

E1 - A2 - S1 - S2: potatoes chips, turnips, cabbages, cucumbers, boiled carrots, onions, mushrooms.

E3: apples, bananas, potatoes, courgettes, aubergines, fennels, artichokes.

E4 - E6: beetroot, potatoes, cabbage, turnips and onions.

E5: tomatoes, lemons, oranges, apples, pineapples and grapefruits.

E8 - E10 - E14: boiled carrots, potatoes, aubergines and beetroot.

## SHREDDING/GRATING DISCS

Z2 - Z3: carrots, celery, potatoes, apples and turnips.

Z4: beetroots, radishes, gruyere-type cheese.

V: parmesan, dry bread, almonds, nuts, hazelnuts.

Z7: mozzarella.

## CUBE CUTTING DISCS

The combination of discs D8x8 - D10x10 - D12x12 - D20x20 - K8x8 - K10x10 - K12x12 - K20x20 with discs E6 - E8 - E10 - E14 obtains a vast number of different types of cubes for minestrone and fruit salads.

## SHOESTRING CUTTING DISCS

H2,5 - H4 - H6 - H8 - H10: celery, courgettes, beetroot, radishes, potatoes and turnips.

The combination of the discs B6 - B8 - B10 with the discs E6 - E8 - E10 allows to obtain shoestrings for the whole length of the product with the desired thickness.

## FR DISQUES A COUPER

E1 - A2 - S1 - S2: frites, céleri-rave, chou, concombres, carotte bouillie, oignons, champignons.

E3: pommes, bananes, pommes de terre, courgettes, aubergines, fenouils, artichauts.

E4 - E6: betteraves, pommes de terre, carottes bouillies, chou, céleris-raves, oignons.

E5: tomates, citrons, oranges, pommes, ananas, pamplemousses.

E8 - E10 - E14: pommes de terre et carottes bouillies, aubergines, betteraves.

## DISQUES À RÂPER / EFFILOCHER

Z2 - Z3: carottes, céleri, pommes de terre, pommes, céleris-raves.

Z4: betteraves, radis, fromage de type gruyère.

V: parmesan, pain sec, amandes, noix, noisettes.

Z7: mozzarella.

## DISQUES POUR LE DÉCOUPAGE EN PETITS CUBES

La combinaison des disques D8x8 - D10x10 - D12x12 - D20x20 - K8x8 - K10x10 - K12x12 - K20x20 avec les E6 - E8 - E10 - E14 permet d'obtenir une grande variété de cubes pour minestrone et salades de fruits.

## DISQUES POUR TAILLER EN JULIENNE

H2,5 - H4 - H6 - H8 - H10: céleri, courgettes, betteraves, radis, pommes de terre, céleris-raves. La combinaison des disques B6 - B8 - B10 aux E6 - E8 - E10 permet d'obtenir une julienne sur toute la longueur du produit avec l'épaisseur souhaitée.

## DE SCHNEIDSCHEBEN FÜR SCHEIBEN

E1 - A2 - S1 - S2: Kartoffelchips, Rüben, Kohlköpfe, Gurken, gekochte Karotten, Zwiebeln, Pilze.

E3: Äpfel, Bananen, Kartoffeln, Zucchini, Auberginen, Fenchel, Artischocken.

E4 - E6: Rote Beete, Salzkartoffeln, Kohl, Rüben und Zwiebeln.

E5: Tomaten, Zitronen, Orangen, Äpfel, Ananas und Grapefruits.

E8 - E10 - E14: Salzkartoffeln, gekochte Karotten, Auberginen und Rote Beete.

## SCHNEIDSCHEBEN ZUM RASPELN UND REIBEN

Z2 - Z3: Karotten, Sellerie, Kartoffeln, Äpfel und Rüben.

Z4: Rote Beete, Rettich, Greyerzkeräse.

V: Parmesan, trockenes Brot, Mandeln, Nüsse, Haselnüsse.

Z7: Mozzarella.

## SCHNEIDSCHEBEN FÜR WÜRFEL

Aus der Kombination der Scheiben D8x8 - D10x10 - D12x12 - D20x20 - K8x8 - K10x10 - K12x12 - K20x20 mit den Scheiben E6 - E8 - E10 - E14 bekommt man eine Vielzahl von verschiedenen Arten von Würfeln für Minestrone und Obstsalate.

## SCHNEIDSCHEBEN FÜR JULIENNESCHNITT

H2,5 - H4 - H6 - H8 - H10: Sellerie, Zucchini, Rote Beete, Wurzeln, Kartoffeln, Rüben. Aus der Kombination der Scheiben B6 - B8 - B10 mit den Scheiben E6 - E8 - E10 bekommt man Julienne-Streifen auf der gesamten Produktlänge in der gewünschten Dicke.

## ES DISCOS PARA REBANAR

E1 - A2 - S1 - S2: Patatas chips, nabos, repollos, pepinos, zanahorias, cebollas y setas.

E3: Manzanas, bananas, patatas, calabacines, berenjenas, hinojos y alcachofas.

E4 - E6: Remolachas, patatas, repollos, nabos y cebollas.

E5: Tomates, limones, naranjas, manzanas, ananá y pomelos.

E8 - E10 - E14: zanahorias hervidas, patatas, zanahorias hervidas, berenjenas y remolachas.

## DISCOS PARA DESMENUZAR O RALLAR

Z2 - Z3: Zanahorias, apio, patatas, manzanas y nabos.

Z4: Remolachas, achicorias, queso tipo gruyere.

V: Queso parmesano, pan seco, almendras, nueces, avellanas.

Z7: mozzarella.

## DISCOS PARA CORTE EN CUBITOS

La combinación de los discos D8x8 - D10x10 - D12x12 - D20x20 - K8x8 - K10x10 - K12x12 - K20x20 con los discos E6 - E8 - E10 - E14 permite obtener una variadísima serie de cubitos para sopas y macedonias.

## DISCOS PARA CORTE EN FORMA DE PAJA

H2,5 - H4 - H6 - H8 - H10: Apio, calabacines, remolacha, achicorias, patatas y nabos. La combinación de los discos B6 - B8 - B10 con los discos E6 - E8 - E10 permite obtener bastoncillos tan largos como el producto y con el espesor deseado.

## RU СЛИЦИНГРОВАННЫЕ ДИСКИ

E1 - A2 - S1 - S2 - S2: картофельные чипсы, репа, капуста, огурцы, морковь, лук, шампиньоны.

E3: яблоки, бананы, картофель, кабачки, баклажаны, фенхель, артишоки.

E4 - E6: свекла, отварной картофель, капуста, репа и лук.

E5: помидоры, лимоны, апельсины, яблоки, ананасы и грейпфруты.

E8 - E10 - E14: отварной картофель и морковь, баклажаны и свекла.

## ИЗМЕЛЧАЮЩИЕ/ОТРАЖАЮЩИЕ ДИСКИ

Z2 - Z3: морковь, сельдерей, картофель, яблоки и репа.

Z4: свекла, редис, сыр грюйер.

V: пармезан, сухой хлеб, миндаль, орехи, лесные орехи.

Z7: Моцарелла.

## КУБИЧЕСКИЕ ОТРЕЗНЫЕ КРУГИ

Комбинация дисков D8x8 - D10x10 - D12x12 - D20x20 - K8x8 - K10x10 - K12x12 - K20x20 с дисками E6 - E8 - E10 - E14 получает огромное количество различных типов кубиков, для минстрона и фруктовых салатов.

## ОТРЕЗНЫЕ ДИСКИ ДЛЯ ОБУВИ

H2,5 - H4 - H6 - H8 - H10: сельдерей, кабачки, свекла, редис, картофель и репа.

Комбинация дисков B6 - B8 - B10 с дисками E6 - E8 - E10 позволяет получить струны обуви по всей длине изделия необходимой толщины.



E1



E3



Z2



Z3



E5



E8



Z4



Z7



E14



S2



REGO



B10



V

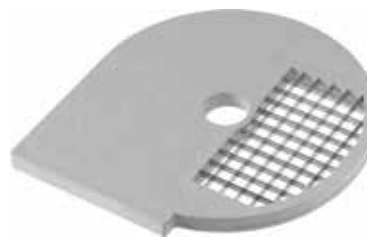

D12



K10

	<p>Portadischi Disk holder Porte-disques Scheibenständer Portadiscos Держатель дисков</p>	<p>Disco inox per affettare regolabile per tagli da 1 a 8 mm Adjustable stainless steel disc for cuts from 1 to 8 mm Disque réglable en acier Inox pour tranches de 1 à 8 mm Einstellbare Edstahlscheibe für Schnitte von 1 bis 8 mm Disco de acero inoxidable regulable para cortes de 1 a 8 mm Диск из нерж стали для резки 1+8 мм</p>	<p>Dischi per affettare Slicing disk Disques à trancher Schneidescheiben Discos para cortar Отрезные диски</p>	<p>Dischi per sfilacciare Shredding discs Disques à effiloche Schneidescheiben zum Raspeln Discos para desmenuzar Измельчающие диски</p>	<p>Dischi per grattugiare Grating discs Disques à râper Schneidescheiben zum Reiben Discos para rallar Отражающие диски</p>	<p>Dischi per taglio a fiammifero Shoestring cutting discs Disques à julienne Julienneschnitt Scheiben Discos para corte en forma de paja Нож для нарезания палочками</p>
Mod.	PORTADISCHI	DISCO REGO	DISCO E1 - A2 - E3 - E4 - E5 E6 - E8 - E10 - E14 S1 - S2	DISCO Z2 - Z3 Z4 - Z7	DISCO V	DISCO H2,5 - H4 - H6 H8 - H10

	Dischi per taglio a fiammiferi Shoestring cutting discs Disques à julienne Julienneschnitt Scheiben Discos para corte en forma de paja Нож для нарезания палочками	Dischi per taglio a cubetti Cubes cutting discs Disque pour couper en dés Würfelschneidescheiben Discos para corte en cubitos Кубические Отрезные Круги	
Mod.	DISCO B6 - B8 - B10	D8x8 D10x10 DX o SX	D12x12 D20x20 DX o SX

	Dischi per taglio a cubetti Cubes cutting discs Disque pour couper en dés Würfelschneidescheiben Discos para corte en cubitos Кубические Отрезные Круги
Mod.	K8x8 - K10x10 K12x12 - K20x20

	Dischi per taglio a cubetti Cubes cutting discs Disque pour couper en dés Würfelschneidescheiben Discos para corte en cubitos Кубические Отрезные Круги		
Mod.	<table border="1"> <tr> <td>D8x8 D10x10 SX</td> <td>D12x12 D20x20 SX</td> </tr> </table>	D8x8 D10x10 SX	D12x12 D20x20 SX
D8x8 D10x10 SX	D12x12 D20x20 SX		

Per ottenere il fiammifero accoppiare il disco E con il disco B.  
 To obtain the shoestring, combine disc E with disc B.  
 Pour couper en julienne utiliser le disque E avec le disque B.  
 Um Stäbchen zu erhalten, die Einsatzscheiben E und B zusammen verwenden.  
 Para obtener la forma de paja combinar el disco E con el disco B.  
 Чтобы получить рукоятку, соедините диск E с диском B.



DISCO E



DISCO B



Per ottenere il cubetto accoppiare il disco E con il disco D.  
 To obtain the cube, combine disc E with disc D.  
 Pour couper le petit cube utiliser le disque E avec le disque D.  
 Um Würfel zu erhalten, die Einsatzscheiben E und B zusammen verwenden.  
 Para obtener el cubito combinar el disco E con el disco D.  
 Для нарезки кубиками использовать диск E вместе D диском K.



DISCO E



DISCO D



#### SOLO PER MODELLO TV4000 / MODEL TV4000 ONLY

Per ottenere il cubetto accoppiare il disco E con il disco K.  
 To obtain the cube, combine disc E with disc K.  
 Pour couper le petit cube utiliser le disque E avec le disque K.  
 Um Würfel zu erhalten, die Einsatzscheiben E und K zusammen verwenden.  
 Para obtener el cubito combinar el disco E con el disco K.  
 Для нарезки кубиками использовать диск E вместе K диском K.



DISCO E



DISCO K





# TAC-TAS



## Tagliamozzarella

MOZZARELLA CUTTER  
COUPE-MOZZARELLA  
MOZZARELLASCHNEIDER  
CORTADORAS DE MOZZARELLA  
КУСАЧЕК МОЦАРЕЛЛЫ

IT Macchina realizzata appositamente per cubettare (TAC) e sfilacciare (TAS) mozzarella. Carcasa in acciaio inox AISI 304 - corpo centrale e coperchio in alluminio anodizzato - dimensione bocca ~ 80x65 mm - microinterruttori di sicurezza su coperchio e maniglia.

**TAC:** in base ai dischi utilizzati si ottengono diverse misure di cubetti.

**TAS:** in base all'utilizzo dei vari dischi si ottiene sia una sfilacciatura mista che un taglio a spaghetti.

EN Machine specifically designed for cutting mozzarella into small cubes (TAC) and shredding (TAS). Stainless steel casing AISI 304 - central case and lid in anodized aluminium - inlet size ~ 80x65 mm - safety microswitches on lid and handle.

**TAC:** depending on the discs used, different sizes of cubes are obtained.

**TAS:** depending on the discs used, both mixed shredding and shoestring cutting are obtained.

FR Machine conçue spécifiquement pour le coupage en petits cubes (TAC) et le filetage (TAS) de la mozzarella. Corps en acier Inox AISI 304 - corps central et couvercle en aluminium anodisé - dimensions orifice d'entrée ~ 80x65 mm - microrupteurs de sécurité sur le couvercle et la poignée.

**TAC:** en fonction des disques utilisés, différentes tailles de cubes sont obtenues.

**TAS:** en fonction des disques utilisé, on obtient aussi bien l'effilochage mixte que la coupe à julienne.

DE Maschine, die speziell für das Schneiden von Mozzarella in kleine Würfel (TAC) und das Zerkleinern (TAS) entwickelt wurde. Gehäuse aus Edelstahl AISI 304 - zentraler Körper und Deckel aus eloxiertem Aluminium - Einführöffnungsgröße ~ 80x65 mm - Sicherheitsmikroschalter an Deckel und Griff.

**TAC:** je nach verwendeter Scheibe werden unterschiedliche Größen von Würfeln erzielt.

**TAS:** je nach verwendeter Scheibe werden sowohl gemischte Zerkleinerung als auch Stäbchen realisiert.

ES Máquinas realizadas especialmente para desmenuzar / deshilar (TAS) y cortar en cubitos. (TAC) la mozzarella. Carcasa de acero inoxidable AISI 304 - cuerpo central y tapa de aluminio - dimensión boca ~ 80x65 mm - microinterruptores de seguridad en la tapa y la manija.

**TAS:** con el uso de los diferentes discos se consiguen tanto un deshilachado mixto como un corte tipo espagueti.

**TAC:** con el uso de los diferentes discos se consiguen diferentes tamaños de cubitos.

RU Машина специально разработана для резки моцареллы на маленькие кубики (TAC) и дробления (TAS). Корпус из нержавеющей стали AISI 304 - центральный корпус и крышка из анодированного алюминия - вставное отверстие ~ 80x65 мм - микровыключатель безопасности на крышке и ручке.

**TAC:** в зависимости от используемого диска получаются кубики разных размеров.

**TAS:** в зависимости от используемого диска производится как смешанное измельчение, так и палочки.

	TAC	TAS
	0,4 kW (0,55 HP) - 1 PH 0,45 kW (0,6 HP) - 3 PH	0,3 kW (0,4 HP) - 1 PH 0,35 kW (0,5 HP) - 3 PH
	230-400V/3/50Hz	
	230V/1N/50Hz	
	140 rpm	300 rpm
	120÷190 Kg/h	250÷300 Kg/h
	330 x 380 x 690(h) mm	
		
	17 Kg	15 Kg
	19 Kg	17 Kg
	430 x 400 x 800(h) mm	
	0,138 m³	



# Optional tagliamozzarella

ACCESSORIES  
ACCESSOIRES  
ZUBEHÖR  
ACCESORIOS  
AKCECCYAPЫ



	<p>Disco 4 lame ondulate 5 mm 4 blades corrugated disk 5 mm Disque 4 lames ondulées 5 mm 5 mm Scheibe mit 4 gewellten Messern Disco de 4 cuchilla onduladas de 5 mm Диск 4 рифлёные лезвия 5 мм</p>	<p>Disco 4 lame ondulate 8 mm 4 blades corrugated disk 8 mm Disque 4 lames ondulées 8 mm 8 mm Scheibe mit 4 gewellten Messern Disco de 4 cuchilla onduladas de 8 mm Диск 4 рифлёные лезвия 8 мм</p>	<p>Disco per sfilacciare ø 4 mm circa Cutting disk for shreds of 4 mm approx Disque pour effiler ø 4 mm environ Scheibe zum Zerkleinern, ø 4 mm zirka Disco para cortar en tiras de unos 4 mm de ø Диск для измельчения ø примерно 4 мм</p>	<p>Disco per sfilacciare ø 7 mm circa Cutting disk for shreds of 7 mm approx Disque pour effiler ø 7 mm environ Scheibe zum Zerkleinern, ø 7 mm zirka Disco para cortar en tiras de unos 7 mm de ø Диск для измельчения ø примерно 7 мм</p>
<b>Mod.</b>	DISCO 4PZ5	DISCO 4PZ8	DISCO PZ4	DISCO PZ7

	<p>Dischi Disks Disques Scheiben DiscoS Диск</p>	<p>Coltello solo per disco NPD altezza 5 mm 5 mm high knife for the NPD disks series only Couteau uniquement pour disque NPD hauteur 5 mm Messer nur für Scheibe NPD, Höhe 5 mm Cuchilla solo para disco NPD de 5 mm de alto Нож только для диска NPD высотой 5 мм</p>
<b>Mod.</b>	NPD 5 mm	COL P5
<b>TAC</b>	<p>8 x 8 x 5 mm 10 x 10 x 5 mm 12 x 12 x 5 mm 16 x 16 x 5 mm 20 x 20 x 5 mm</p>	-

	<p>Dischi Disks Disques Scheiben DiscoS Диск</p>	<p>Coltello solo per disco NPD altezza 8 mm 8 mm high knife for the NPD disks series only Couteau uniquement pour disque NPD hauteur 8 mm Messer nur für Scheibe NPD, Höhe 8 mm Cuchilla solo para disco NPD de 8 mm de alto Нож только для диска NPD высотой 8 мм</p>
<b>Mod.</b>	NPD 8 mm	COL P8
<b>TAC</b>	<p>8 x 8 x 8 mm 10 x 10 x 8 mm 12 x 12 x 8 mm 16 x 16 x 8 mm 20 x 20 x 8 mm</p>	-



TAS-4PZ8



TAS-PZ4



TAS-PZ7



TAC-P5



TAC-NPD8X8

#### MODELLO TAS / ONLY MODEL TAS

Può utilizzare anche i dischi della serie E-H-Z-V.  
May also be used with the disks of the series E-H-Z-V.  
Peut également utiliser les disques de la série E-H-Z-V.  
Kann auch die Scheiben der Serie E-H-Z-V verwenden.  
Pueden usarse también los discos de la serie E-H-Z-V.  
Можно также использовать диски серии E-H-Z-V.

CL3N  
CL5N  
CL8N



Cutter

- IT** Macchina per tritare, impastare, sminuzzare e mescolare. Carcassa e vasca in acciaio inox AISI 304 - coperchio superiore in polycarbonato alimentare trasparente - pulsantiera a pressione - microinterruttori di sicurezza sul coperchio e sulla base d' appoggio vasca - freno motore - capacità vasca 3-5-8 litri - dotato di un coltello a 2 lame taglienti.
- EN** Machine for shredding, kneading, chopping and mixing. Casing and bowl in stainless steel AISI 304 - upper lid in clear alimentary polycarbonate - pressure switch - safety microswitches on lid and bowl support base - motor brake - bowl capacity 3-5-8 litres - equipped with a knife with 2 sharp blades.
- FR** Machine pour hacher, triturer, homogénéiser et mélanger. Corps et cuve en acier Inox AISI 304 - couvercle supérieur en polycarbonate alimentaire transparent - interrupteur à pression - microinterrupteur de sécurité sur le couvercle et le pied support cuve - frein moteur - capacité cuve 3-5-8 litres - équipé d'un couteau avec 2 lames pointues.
- DE** Maschine zum Zerkleinern, Kneten, Häckseln und Mischen. Gehäuse und Schüssel aus Edelstahl AISI 304 - oberer Deckel aus durchsichtigem lebensmitteltauglichem Polykarbonat - Druckknopf - Sicherheitsmikroschalter am Deckel und Schüsselträgerfuß - Motorbremse - Schüsselinhalt 3-5-8 Liter - ausgestattet mit einem Messer mit 2 scharfen Klingen.
- ES** Máquina para amasar, desmenuzar y mezclar. Carcasa y bol de acero inoxidable AISI 304 - tapa superior de polycarbonato transparente para alimentos - botonera a presión - microinterruptores de seguridad en la tapa y en el soporte del bol - freno motor - capacidad del bol 3-5-8 litros - en la dotación un cuchillo de dos hojas cortantes.
- RU** Машина для дробления, перемешивания, измельчения и смешивания. Корпус и чаша из нержавеющей стали AISI 304 - прозрачная верхняя крышка из поликарбоната - реле давления - предохранительный микровыключатель на крышке и опоре барабана - тормоз мотора - емкость барабана 3-5-8 литров - оснащен ножом с 2 острыми лезвиями.

	CL3N	CL5N	CL8N
	0,75 kW (1 HP)		
	230-400V/3-3N/50Hz		
	230V/1N/50Hz		
	1400 rpm		
	3 L ø 210 x 105(h) mm liquidi/ liquids max. 1,8 L	5 L ø 210 x 160(h) mm liquidi/ liquids max. 2,1 L	8 L ø 210 x 205(h) mm liquidi/ liquids max. 2,4 L
	240 x 310 x 485(h) mm	240 x 310 x 545(h) mm	240 x 310 x 595(h) mm
			
	18 Kg	19 Kg	
	20 Kg	21 Kg	
	400 x 300 x 670(h) mm		
	0,080 m³		

CL5NV2  
CL8NV2



CL5NV2

Cutter

- IT** Macchina per tritare, impastare, sminuzzare e mescolare. Carcassa e vasca in acciaio inox AISI 304 - coperchio superiore in polycarbonato alimentare trasparente - pulsantiera a pressione - microinterruttori di sicurezza sul coperchio e sulla base d' appoggio vasca - freno motore - capacità vasca 5-8 litri - dotato di un coltello a 2 lame taglienti - doppia velocità.
- EN** Machine for shredding, kneading, chopping and mixing. Casing and bowl in stainless steel AISI 304 - upper lid in clear alimentary polycarbonate - pressure switch - safety microswitches on lid and bowl support base - motor brake - bowl capacity 5-8 litres - equipped with a knife with 2 sharp blades - double speed.
- FR** Machine pour hacher, triturer, homogénéiser et mélanger. Corps et cuve en acier Inox AISI 304 - couvercle supérieur en polycarbonate alimentaire transparent - interrupteur à pression - microinterrupteur de sécurité sur le couvercle et le pied support cuve - frein moteur - capacité cuve 5-8 litres - équipé d'un couteau avec 2 lames pointues - double vitesse.
- DE** Maschine zum Zerkleinern, Kneten, Häckseln und Mischen. Gehäuse und Schüssel aus Edelstahl AISI 304 - oberer Deckel aus durchsichtigem lebensmitteltauglichem Polykarbonat - Druckknopf - Sicherheitsmikroschalter am Deckel und Schüsselträgerfuß - Motorbremse - Schüsselinhalt 5-8 Liter - ausgestattet mit einem Messer mit 2 scharfen Klingen - doppelte Geschwindigkeit.
- ES** Máquina para amasar, desmenuzar y mezclar. Carcasa y bol de acero inoxidable AISI 304 - tapa superior de polycarbonato transparente para alimentos - botonera a presión - microinterruptores de seguridad en la tapa y en el soporte del bol - freno motor - capacidad del bol 5-8 litros - en la dotación un cuchillo de dos hojas cortantes - doble velocidad.
- RU** Машина для дробления, перемешивания, измельчения и смешивания. Корпус и чаша из нержавеющей стали AISI 304 - прозрачная верхняя крышка из поликарбоната - реле давления - предохранительный микровыключатель на крышке и опоре барабана - тормоз мотора - емкость барабана 5-8 литров - оснащен ножом с 2 острыми лезвиями - двойная скорость.

	CL5NV2	CL8NV2
	0,6-0,8 kW (0,8 -1,1 HP)	
 3 Ph	400V/3N/50Hz	
 RPM	1400 rpm - 1400/2800 rpm - 2 <sup>nd</sup> speed	
 L	5 L ø 210 x 160(h) mm liquidi/ liquids max. 2,1 L	8 L ø 210 x 205(h) mm liquidi/ liquids max. 2,4 L
 mm	240 x 310 x 545(h) mm	240 x 310 x 595(h) mm
		
 NET Kg	21 Kg	
 GROSS Kg	23 Kg	
 mm	400 x 300 x 670(h) mm	
 m <sup>3</sup>	0,080 m <sup>3</sup>	

BC3N  
BC5N  
BC8N



BC3N



BC5N



Cutter

- IT** Carcassa in alluminio anodizzato - vasca e lame estraibili in acciaio inox - coperchio superiore in policarbonato alimentare trasparente - microinterruttori di sicurezza su coperchio e vasca - capacità vasca 3-5-8 litri - dotato di coltello a 2 lame taglienti.
- EN** Anodized aluminium casing - removable stainless steel bowl and blades - upper lid in clear alimentary polycarbonate - safety microswitches on lid and bowl - bowl capacity 3-5-8 litres - equipped with a knife with 2 sharp blades.
- FR** Corps en aluminium anodisé - cuve et lames amovibles en acier Inox - couvercle supérieur en polycarbonate alimentaire transparent - microinterrupteur de sécurité sur le couvercle et la cuve - capacité cuve 3-5-8 litres - équipé d'un couteau avec 2 lames pointues.
- DE** Eloxiertes Aluminiumgehäuse - abnehmbare Edelstahlschüssel und -klingen - oberer Deckel aus durchsichtigem lebensmitteltauglichem Polykarbonat - Druckknopf - Sicherheitsmikroschalter am Deckel und Schüsselträgerfuß - Motorbremse - Schüsselinhalt 3-5-8 Liter - ausgestattet mit einem Messer mit 2 scharfen Klingen.
- ES** Carcasa de aluminio anodizado - bol y cuchillas extraíbles de acero inoxidable AISI 304 - tapa superior de policarbonato transparente para alimentos - microinterruptores de seguridad en la tapa y el bol - capacidad del bol 3-5-8 litros - dotado de cuchillo con 2 hojas cortantes.
- RU** Корпус из анодированного алюминия - Съёмная чаша и лезвия из нержавеющей стали - прозрачная верхняя крышка из поликарбоната - кнопка - предохранительный микровыключатель на крышке и опорной лапке - моторный тормоз - объем барабана 3-5-8 литров - оснащен ножом с 2 острыми лезвиями.

	BC3N	BC5N	BC8N
	0,37 kW (0,5 HP)	0,75 kW (1 HP)	
	230V/1N/50Hz		
	1300 rpm		
	3 L ø 210 x 110 (h) mm liquidi/ liquids max. 1,7 L	5 L ø 210 x 160(h) mm liquidi/ liquids max. 2,8 L	8 L ø 210 x 210(h) mm liquidi/ liquids max. 4 L
	520 x 320 x 620(h) mm	710 x 320 x 850(h) mm	710 x 320 x 900(h) mm
			
	12 Kg	24 Kg	25 Kg
	13,5 Kg	26 Kg	27 Kg
	470 x 380 x 380(h) mm	485 x 630 x 530(h) mm	485 x 630 x 550(h) mm
	0,067 m³	0,160 m³	0,170 m³

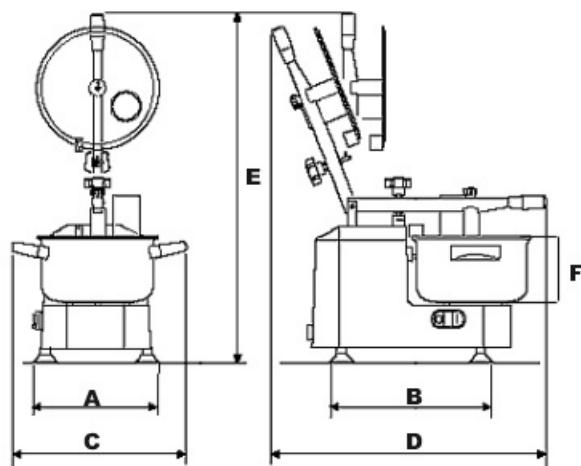

	BC3N	BC5N	BC8N
A	200 mm	260 mm	
B	270 mm	360 mm	
C	320 mm	320 mm	
D	520 mm	710 mm	
E	620 mm	850 mm	900 mm
F	110 mm	160 mm	210 mm

BC5NV  
BC8NV













BC5NV



Cutter



- IT** Carcassa in alluminio anodizzato - vasca e lame estraibili in acciaio inox - coperchio superiore in policarbonato alimentare trasparente - microinterruttori di sicurezza su coperchio e vasca - capacità vasca 5-8 litri - dotato di coltello a 2 lame taglienti - variatore di velocità.
- EN** Anodized aluminium casing - removable stainless steel bowl and blades - upper lid in clear alimentary polycarbonate - safety microswitches on lid and bowl - bowl capacity 5-8 litres - equipped with a knife with 2 sharp blades - double speed.
- FR** Corps en aluminium anodisé - cuve et lames amovibles en acier Inox - couvercle supérieur en polycarbonate alimentaire transparent - microinterrupteur de sécurité sur le couvercle et la cuve - capacité cuve 5-8 litres - équipé d'un couteau avec 2 lames pointues - double vitesse.
- DE** Eloxiertes Aluminiumgehäuse - abnehmbare Edelstahlschüssel und -klingen - oberer Deckel aus durchsichtigem lebensmitteltauglichem Polykarbonat - Druckknopf - Sicherheitsmikroschalter am Deckel und Schüsselträgerfuß - Motorbremse - Schüsselinhalt 5-8 Liter - ausgestattet mit einem Messer mit 2 scharfen Klingen - doppelte Geschwindigkeit.
- ES** Carcasa de aluminio anodizado - bol y cuchillas extraíbles de acero inoxidable AISI 304 - tapa superior de policarbonato transparente para alimentos - microinterruptores de seguridad en la tapa y el bol - capacidad del bol 5-8 litros - dotado de cuchillo con 2 hojas cortantes. - variador de velocidad.
- RU** Корпус из анодированного алюминия - Съемная чаша и лезвия из нержавеющей стали - прозрачная верхняя крышка из поликарбоната - кнопка - предохранительный микровыключатель на крышке и опорной лапке - моторный тормоз - объем барабана 5-8 литров - оснащен ножом с 2 острыми лезвиями - двойная скорость.

	BC5NV	BC8NV
	0,75 kW (1 HP)	
	230V/1N/50Hz	
	260±2120 rpm	
	5 L ø 210 x 160(h) mm liquidi/ liquids max. 2,8 L	8 L ø 210 x 210(h) mm liquidi/ liquids max. 4 L
	710 x 320 x 850(h) mm	710 x 320 x 900(h) mm
		
	24 Kg	25 Kg
	26 Kg	27 Kg
	485 x 630 x 530(h) mm	485 x 630 x 550(h) mm
	0,160 m³	0,170 m³

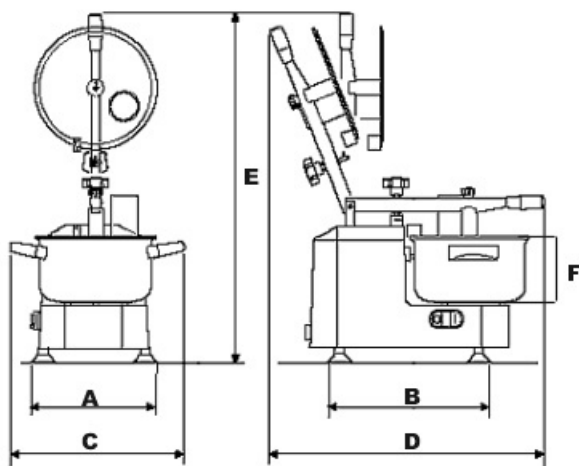

	BC5NV	BC8NV
A	260 mm	
B	360 mm	
C	320 mm	
D	710 mm	
E	850 mm	900 mm
F	160 mm	210 mm



BC3N



CL5N



BC5NV

# Optional cutter

ACCESSORIES  
ACCESSOIRES  
ZUBEHÖR  
ACCESORIOS  
AKCECCYAPЫ

	<p>Coltello 2 lame (tagliante o sbattitore)          2 blades knife (cutting or mixing)          Couteau 2 lames (tranchant ou batteur)          2-Klingen-Messer (zum Schneiden oder Mixen)          Cuchillo de 2 cuchillos (cortador o batidor)          2-лопастной нож (для нарезки или смешивания)</p>		<p>Coltello 4 lame (tagliante o sbattitore)          4 blades knife (cutting or mixing)          Couteau 4 lames (tranchant ou batteur)          4-Klingen-Messer (zum Schneiden oder Mixen)          Cuchillo de 4 cuchillos (cortador o batidor)          4-лопастной нож (для нарезки или смешивания)</p>	
Mod.	CL3N	CL5N-CL8N	CL5N-CL8N	
	COLCL3L2	COLCL58L2S	COLCL58L4 - COLCL58L4S	
				

	<p>Coltello 2 lame (tagliante o sbattitore)          2 blades knife (cutting or mixing)          Couteau 2 lames (tranchant ou batteur)          2-Klingen-Messer (zum Schneiden oder Mixen)          Cuchillo de 2 cuchillos (cortador o batidor)          2-лопастной нож (для нарезки или смешивания)</p>		<p>Coltello 4 lame (tagliante o sbattitore)          4 blades knife (cutting or mixing)          Couteau 4 lames (tranchant ou batteur)          4-Klingen-Messer (zum Schneiden oder Mixen)          Cuchillo de 4 cuchillos (cortador o batidor)          4-лопастной нож (для нарезки или смешивания)</p>	
Mod.	BC3N	BC5N - BC8N	BC5N - BC8N	
	COLBC3NL2 - COLBC3NL2S	COLBC58NL2 - COLBC58NL2S	COLBC58NL4 - COLBC58NL4S	
				

# PPN5 PPF5



PPF5

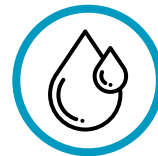

CARICO/SCARICO ACQUA  
WATER INLET / OUTLET  
ВХОД/ВЫХОД ВОДЫ



PPN5

Pelapatate

POTATO PEELER  
ÉPLUCHEUSE À POMMES DE TERRE  
KARTOFFELSCHÄLER  
PELAPAPAS  
КАРТОФЕЛЕЧИСТКА

IT Macchina per pelare patate. Struttura in acciaio inox AISI 304 - coperchio superiore in policarbonato alimentare trasparente - microinterruttori di sicurezza su coperchio superiore e su bocca di uscita - pulsante espulsione prodotto - timer 0÷4 minuti - getto automatico d'acqua per favorire l'eliminazione dei residui di pelatura - **in dotazione piattello abrasivo estraibile PTA**. Il modello PPN5 è da banco.

EN Potato peeler. Structure in stainless steel AISI 304 - upper cover in clear alimentary polycarbonate - safety microswitches on the upper lid and on the inlet - product ejection button - timer 0÷4 minutes - automatic water jet to facilitate the elimination of peeling waste - **extractable abrasive plate enclosed PTA**. Table-top model PPN5.







FR Eplucheur de pommes de terre. Corps en acier Inox AISI 304 - couvercle supérieur en polycarbonate alimentaire transparent - micro-interrupteurs de sécurité sur le couvercle supérieur et sur l'orifice d'entrée - bouton d'éjection du produit - temporisateur 0÷4 minutes - jet d'eau automatique pour l'élimination du pelage - **de série plaque abrasive extractible PTA**. PPN5: modèle de table.

DE Kartoffelschäler. Gehäuse aus Edelstahl AISI 304 - oberer Deckel aus durchsichtigem, lebensmitteltauglichem Polycarbonat - Sicherheitsmikroschalter am oberen Deckel und an der Einführöffnung - Produktauswurfstaste - Timer 0÷4 Minuten - automatischer Wasserstrahl zur leichteren Abreinigung - **abnehmbare Schleifplatte beigefügt PTA**. Tischmodell PPN5.

ES Pelador de papas. Estructura de acero inoxidable AISI 304 - tapa superior de policarbonato transparente para alimentos - microinterruptores de seguridad en la tapa y la boca de salida - botón para la expulsión del producto - temporizador 0÷4 minutos - chorro de agua automático para favorecer la eliminación de los residuos de peladura - **en la dotación plato abrasivo extraíble PTA**. El modelo PPN5 es de sobremesa.

RU Очиститель картофеля. Конструкция из нержавеющей стали AISI 304 - верхняя крышка из прозрачного пищевого поликарбоната - предохранительные микровыключатели на верхней крышке и на входном отверстии - кнопка выброса продукта - таймер 0÷4 минуты - автоматическая струя воды для снятия пилинга - **стандартная съемная абразивная плита PTA**. PPN5: настольная модель.

	PPN5	PPF5
	0,37 kW (0,5 HP)	
	230-400V/3-3N/50Hz	
	230V/1N/50Hz	
	± 5 Kg max	
	60 Kg/h	
	no	si / yes
	520 x 630 x 590(h) mm	520 x 700 x 1010(h) mm
		
	28 Kg	27 Kg
	39 Kg	38 Kg
	830 x 530 x 740(h) mm	
	0,326 m³	

	CI	
	3,2 Kg	 4,7 Kg
	600 x 410 x 490(h) mm	 0,121 m³
	560 x 380 x 440(h) mm	

# PPN10M PPF10M

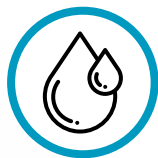

CARICO/SCARICO ACQUA  
WATER INLET / OUTLET  
ВХОД/ВЫХОД ВОДЫ



PPN10M  
CON ABRASIVO LATERALE (OPTIONAL)  
WITH LATERAL ABRASIVE (OPTIONAL)



PPF

# Pelapatate

POTATO PEELER  
ÉPLUCHEUSE À POMMES DE TERRE  
KARTOFFELSCHÄLER  
PELAPAPAS  
КАРТОФЕЛЕЧИСТКА



GUARDA IL VIDEO  
WATCH THE VIDEO

IT Macchina per pelare patate. Struttura in acciaio inox AISI 304 - coperchio superiore in policarbonato alimentare trasparente - microinterruttori di sicurezza su coperchio superiore e su bocca di uscita - pulsante espulsione prodotto - timer 0÷4 minuti - getto automatico d'acqua per favorire l'eliminazione dei residui di pelatura - **in dotazione piattello abrasivo estraibile PTA.**

EN Potato peeler. Structure in stainless steel AISI 304 - upper cover in clear alimentary polycarbonate - safety microswitches on the upper lid and on the inlet - product ejection button - timer 0÷4 minutes - automatic water jet to facilitate the elimination of peeling waste - **extractable abrasive plate enclosed PTA.**







FR Eplucheur de pommes de terre. Corps en acier Inox AISI 304 - couvercle supérieur en polycarbonate alimentaire transparent - micro-interrupteurs de sécurité sur le couvercle supérieur et sur l'orifice d'entrée - bouton d'éjection du produit - temporisateur 0÷4 minutes - jet d'eau automatique pour l'élimination du pelage - **de série plaque abrasive extractible PTA.**

DE Kartoffelschäler. Gehäuse aus Edelstahl AISI 304 - oberer Deckel aus durchsichtigem, lebensmitteltauglichem Polycarbonat - Sicherheitsmikroschalter am oberen Deckel und an der Einführöffnung - Produktauswurfstaste - Timer 0÷4 Minuten - automatischer Wasserstrahl zur leichteren Abreinigung - **abnehmbare Schleifplatte beigefügt PTA.**

ES Pelador de papas. Estructura de acero inoxidable AISI 304 - tapa superior de policarbonato transparente para alimentos - microinterruptores de seguridad en la tapa y la boca de salida - botón para la expulsión del producto - temporizador 0÷4 minutos - chorro de agua automático para favorecer la eliminación de los residuos de peladura - **en la dotación plato abrasivo extraíble PTA.**

RU Очиститель картофеля. Конструкция из нержавеющей стали AISI 304 - верхняя крышка из прозрачного пищевого поликарбоната - предохранительные микровыключатели на верхней крышке и на входном отверстии - кнопка выброса продукта - таймер 0÷4 минуты - автоматическая струя воды для снятия пилинга - **стандартная съёмная абразивная плита PTA.**

	PPN10M	PPF10M
	0,75 kW (1 HP)	
	230-400V/3-3N/50Hz	
	230V/1N/50Hz	
	± 10 Kg max	
	120 Kg/h	
	no	si / yes
	400 x 770 x 860(h) mm	380 x 770 x 1160(h) mm
		
	36 Kg	34 Kg
	47 Kg	45 Kg
	830 x 530 x 950(h) mm	830 x 530 x 740(h) mm
	0,463 m³	0,326 m³

	CI	
	3,2 Kg	 4,7 Kg
	600 x 410 x 490(h) mm	 0,121 m³
	560 x 380 x 440(h) mm	



OPTIONAL  
CON ABRASIVO LATERALE  
WITH LATERAL ABRASIVE

OPTIONAL



218

# PPN18M PPF18M

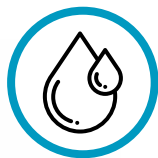

CARICO/SCARICO ACQUA  
WATER INLET / OUTLET  
ВХОД/ВЫХОД ВОДЫ



PPN  
CON ABRASIVO LATERALE (OPTIONAL)  
WITH LATERAL ABRASIVE (OPTIONAL)



PPF

## Pelapatate

POTATO PEELER  
ÉPLUCHEUSE À POMMES DE TERRE  
KARTOFFELSCHÄLER  
PELAPAPAS  
КАРТОФЕЛЕЧИСТКА



GUARDA IL VIDEO  
WATCH THE VIDEO



IT Macchina per pelare patate. Struttura in acciaio inox AISI 304 - coperchio superiore in policarbonato alimentare trasparente - microinterruttori di sicurezza su coperchio superiore e su bocca di uscita - pulsante espulsione prodotto - timer 0÷4 minuti - getto automatico d'acqua per favorire l'eliminazione dei residui di pelatura - **in dotazione piattello abrasivo estraibile PTA.**













EN Potato peeler. Structure in stainless steel AISI 304 - upper cover in clear alimentary polycarbonate - safety microswitches on the upper lid and on the inlet - product ejection button - timer 0÷4 minutes - automatic water jet to facilitate the elimination of peeling waste - **extractable abrasive plate enclosed PTA.**







FR Eplucheur de pommes de terre. Corps en acier Inox AISI 304 - couvercle supérieur en polycarbonate alimentaire transparent - micro-interrupteurs de sécurité sur le couvercle supérieur et sur l'orifice d'entrée - bouton d'éjection du produit - temporisateur 0÷4 minutes - jet d'eau automatique pour l'élimination du pelage - **de série plaque abrasive extractible PTA.**

DE Kartoffelschäler. Gehäuse aus Edelstahl AISI 304 - oberer Deckel aus durchsichtigem, lebensmitteltauglichem Polycarbonat - Sicherheitsmikroschalter am oberen Deckel und an der Einführöffnung - Produktauswurfstaste - Timer 0÷4 Minuten - automatischer Wasserstrahl zur leichteren Abreinigung - **abnehmbare Schleifplatte beigefügt PTA.**

ES Pelador de papas. Estructura de acero inoxidable AISI 304 - tapa superior de policarbonato transparente para alimentos - microinterruptores de seguridad en la tapa y la boca de salida - botón para la expulsión del producto - temporizador 0÷4 minutos - chorro de agua automático para favorecer la eliminación de los residuos de peladura - **en la dotación plato abrasivo extraíble PTA.**

RU Очиститель картофеля. Конструкция из нержавеющей стали AISI 304 - верхняя крышка из прозрачного пищевого поликарбоната - предохранительные микровыключатели на верхней крышке и на входном отверстии - кнопка выброса продукта - таймер 0÷4 минуты - автоматическая струя воды для снятия пилинга - **стандартная съёмная абразивная плита PTA.**

	PPN18M	PPF18M
	1,1 kW (1,5 HP)	
	230-400V/3-3N/50Hz	
	230V/1N/50Hz	
	± 18 Kg max	
	220 Kg/h	
	no	si / yes
	400 x 770 x 930(h) mm	380 x 770 x 1230(h) mm
		
	41 Kg	39 Kg
	52 Kg	50 Kg
	830 x 530 x 950(h) mm	
	0,463 m³	

	CI	
	3,2 Kg	 4,7 Kg
	600 x 410 x 490(h) mm	 0,121 m³
	560 x 380 x 440(h) mm	



OPTIONAL  
CON ABRASIVO LATERALE  
WITH LATERAL ABRASIVE

# PPN25 PPF25

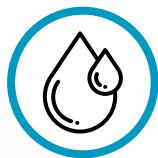

CARICO/SCARICO ACQUA  
WATER INLET / OUTLET  
ВХОД/ВЫХОД ВОДЫ



PPN  
CON ABRASIVO LATERALE  
WITH LATERAL ABRASIVE



PPF25

OPTIONAL  
CASSETTO CON FILTRO  
DRAWER AND FILTER

# Pelapatate

POTATO PEELER  
ÉPLUCHEUSE À POMMES DE TERRE  
KARTOFFELSCHÄLER  
PELAPAPAS  
КАРТОФЕЛЕЧИСТКА



GUARDA IL VIDEO  
WATCH THE VIDEO

IT Macchina per pelare patate. Struttura in acciaio inox AISI 304 - coperchio superiore in polycarbonato alimentare trasparente - microinterruttori di sicurezza su coperchio superiore e su bocca di uscita - pulsante espulsione prodotto - timer 0÷4 minuti - getto automatico d'acqua per favorire l'eliminazione dei residui di pelatura - **in dotazione piattello abrasivo estraibile PTA e abrasivo laterale di serie.**







EN Potato peeler. Structure in stainless steel AISI 304 - upper cover in clear alimentary polycarbonate - safety microswitches on the upper lid and on the inlet - product ejection button - timer 0÷4 minutes - automatic water jet to facilitate the elimination of peeling waste - **extractable PTA abrasive plate and lateral abrasive enclosed.**







FR Eplucheur de pommes de terre. Corps en acier Inox AISI 304 - couvercle supérieur en polycarbonate alimentaire transparent - micro-interrupteurs de sécurité sur le couvercle supérieur et sur l'orifice d'entrée - bouton d'éjection du produit - temporisateur 0÷4 minutes - jet d'eau automatique pour l'élimination du pelage - **de série plaque abrasive extractible PTA et côtés abrasifs.**

DE Kartoffelschäler. Struktur aus Edelstahl AISI 304 - oberer Deckel aus durchsichtigem, lebensmitteltauglichem Polycarbonat - Sicherheitsmikroschalter am oberen Deckel und an der Einführöffnung - Produktauswurfstaste - Timer 0÷4 Minuten - automatischer Wasserstrahl zur leichteren Abreinigung - **abnehmbare Schleifplatte und Schleifseiten beigefügt PTA.**

ES Máquina para pelar patatas y zanahorias. Estructura de acero inoxidable AISI 304 - tapa superior de polycarbonato transparente para alimentos - microinterruptores de seguridad en la tapa y la boca de salida - botón para la expulsión del producto - temporizador 0÷4 minutos - chorro de agua automático para favorecer la eliminación de los residuos de peladura - **en la dotación plato abrasivo extraíble PTA y abrasivo lateral.**

RU Очиститель картофеля. Конструкция из нержавеющей стали AISI 304 - верхняя крышка из прозрачного пищевого поликарбоната - предохранительные микровыключатели на верхней крышке и на входном отверстии - кнопка выброса продукта - таймер 0÷4 минуты - автоматическая струя воды для снятия пилинга - **стандартная съемная абразивная плита PTA.**

	PPN25	PPF25
	1,1 kW (1,5 HP)	
	230-400V/3-3N/50Hz	
	230V/1N/50Hz	
	± 25 Kg max	
	450 Kg/h	
	no	si / yes
	540 x 900 x 1040(h) mm	450 x 900 x 1355(h) mm
		
	61 Kg	57 Kg
	81 Kg	77 Kg
	1105 x 600 x 1123(h) mm	
	0,775 m³	

	CB	
	6.5 Kg	 8 Kg
	680 x 450 x 500(h) mm	 0,153 m³
	670 x 450 x 410(h) mm	

# LCN5 LCF5



CARICO/SCARICO ACQUA  
WATER INLET / OUTLET  
ВХОД/ВЫХОД ВОДЫ



LCN5



# Lavacozze

MUSSEL WASHER  
LAVE-MOULES  
MUSCHELNWASCHMASCHINE  
LAVADORAS DE MEJILLONES  
МАШИНА ДЛЯ ОЧИСТКИ МИДИЙ

IT Macchina per pulire le cozze. Struttura in acciaio inox AISI 304 - coperchio superiore in policarbonato alimentare trasparente - microinterruttori di sicurezza su coperchio superiore e su bocca di uscita - pulsante espulsione prodotto - timer 0÷4 minuti - getto automatico d'acqua per favorire l'eliminazione dei residui di pulitura - **in dotazione piattello a spazzole estraibile PPC**. Il modello LCN5 è da banco.

EN Mussels cleaning machine. Structure in stainless steel AISI 304 - upper cover in clear alimentary polycarbonate - safety microswitches on the upper lid and on the inlet - product ejection button - timer 0÷4 minutes - automatic water jet to facilitate the elimination of peeling waste - **extractable plate with brushes PPC enclosed**. Table-top model LCN5.







FR Machine à laver les moules. Corps en acier Inox AISI 304 - couvercle supérieur en polycarbonate alimentaire transparent - micro-interrupteurs de sécurité sur le couvercle supérieur et sur l'orifice d'entrée - bouton d'éjection du produit - temporisateur 0÷4 minutes - jet d'eau automatique pour l'élimination des résidus - **de série plaque extractible à brosses PPC**. LCN5: modèle de table.

DE Maschine zum Säubern von Miesmuscheln. Gehäuse aus Edelstahl AISI 304 - oberer Deckel aus durchsichtigem, lebensmitteleuglichem Polycarbonat - Sicherheitsmikroschalter am oberen Deckel und an der Einführöffnung - Produktauswurfstaste - Timer 0÷4 Minuten - automatischer Wasserstrahl zur leichteren Abreinigung - **abnehmbare PPC Platte mit Bürsten beigefügt**. Tischmodell LCN5.

ES Máquina para lavar mejillones. Estructura de acero inoxidable AISI 304 - tapa superior de policarbonato transparente para alimentos - microinterruptores de seguridad en la tapa y la boca de salida - botón para la expulsión del producto - temporizador 0÷4 minutos - chorro de agua automático para favorecer la eliminación de los residuos de la limpieza - **en la dotación plato extraíble con cepillos PPC**. El modelo LCN5 es de sobremesa.

RU Машина для очистки мидий. Корпус из нержавеющей стали AISI 304 - верхняя крышка из прозрачного поликарбоната подходит для пищевых продуктов - безопасный микровыключатель на верхней крышке и вставном отверстии - кнопка выброса продукта - таймер 0÷4 минуты - автоматическая струя воды для облегчения очистки - **съёмная пластина PPC с щетками**. Настольная модель LCN5.

	LCN5	LCF5
	0,26 kW (0,35 HP)	
	230-400V/3-3N/50Hz	
	230V/1N/50Hz	
	± 3/5 Kg max	
	60 Kg/h	
	no	si / yes
	520 x 630 x 590(h) mm	520 x 700 x 1010(h) mm
		
	28 Kg	27 Kg
	39 Kg	38 Kg
	830 x 530 x 740(h) mm	
	0,326 m³	

	CI	
	3,2 Kg	 4,7 Kg
	600 x 410 x 490(h) mm	 0,121 m³
	560 x 380 x 440(h) mm	

# LCN10M LCF10M

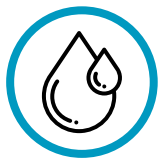

CARICO/SCARICO ACQUA  
WATER INLET / OUTLET  
ВХОД/ВЫХОД ВОДЫ









LCF

# Lavacozze

MUSSEL WASHER  
LAVE-MOULES  
MUSCHELNWASCHMASCHINE  
LAVADORAS DE MEJILLONES  
МАШИНА ДЛЯ ОЧИСТКИ МИДИЙ

- IT Macchina per pulire le cozze. Struttura in acciaio inox AISI 304 - coperchio superiore in policarbonato alimentare trasparente - microinterruttori di sicurezza su coperchio superiore e su bocca di uscita - pulsante espulsione prodotto - timer 0÷4 minuti - getto automatico d'acqua per favorire l'eliminazione dei residui di pulitura - **in dotazione piattello a spazzole estraibile PPC.**
- EN Mussels cleaning machine. Structure in stainless steel AISI 304 - upper cover in clear alimentary polycarbonate - safety microswitches on the upper lid and on the inlet - product ejection button - timer 0÷4 minutes - automatic water jet to facilitate the elimination of peeling waste - **extractable plate with brushes PPC enclosed.**
- FR Machine à laver les moules. Corps en acier Inox AISI 304 - couvercle supérieur en polycarbonate alimentaire transparent - micro-interrupteurs de sécurité sur le couvercle supérieur et sur l'orifice d'entrée - bouton d'éjection du produit - temporisateur 0÷4 minutes - jet d'eau automatique pour l'élimination des résidus - **de série plaque extractible à brosses PPC.**
- DE Maschine zum Säubern von Miesmuscheln. Gehäuse aus Edelstahl AISI 304 - oberer Deckel aus durchsichtigem, lebensmitteleuglichem Polycarbonat - Sicherheitsmikroschalter am oberen Deckel und an der Einführöffnung - Produktauswurfstaste - Timer 0÷4 Minuten - automatischer Wasserstrahl zur leichteren Abreinigung - **abnehmbare PPC Platte mit Bürsten beigegefügt.**
- ES Máquina para lavar mejillones. Estructura de acero inoxidable AISI 304 - tapa superior de policarbonato transparente para alimentos - microinterruptores de seguridad en la tapa y la boca de salida - botón para la expulsión del producto - temporizador 0÷4 minutos - chorro de agua automático para favorecer la eliminación de los residuos de la limpieza - **en la dotación plato extraíble con cepillos PPC.**
- RU Машина для очистки мидий. Корпус из нержавеющей стали AISI 304 - верхняя крышка из прозрачного поликарбоната подходит для пищевых продуктов - безопасный микровыключатель на верхней крышке и вставном отверстии - кнопка выброса продукта - таймер 0÷4 минуты - автоматическая струя воды для облегчения очистки - **съёмная пластина PPC с щетками.**

	LCN10M	LCF10M
	0,55 kW (0,75 HP)	
	230-400/3-3N/50Hz	
	230V/1N/50Hz	
	± 6/10 Kg max	
	120 Kg/h	
	no	si / yes
	400 x 770 x 860(h) mm	380 x 770 x 1160(h) mm
		
	36 Kg	34 Kg
	47 Kg	45 Kg
	830 x 530 x 950(h) mm	830 x 530 x 740(h) mm
	0,463 m³	0,326 m³

	CI	
	3,2 Kg	 4,7 Kg
	600 x 410 x 490(h) mm	 0,121 m³
	560 x 380 x 440(h) mm	

# LCN18M LCF18M



CARICO/SCARICO ACQUA  
WATER INLET / OUTLET  
ВХОД/ВЫХОД ВОДЫ



LCF18M

Lavacozze

MUSSEL WASHER  
LAVE-MOULES  
MUSCHELNWASCHMASCHINE  
LAVADORAS DE MEJILLONES  
МАШИНА ДЛЯ ОЧИСТКИ МИДИЙ



IT Macchina per pulire le cozze. Struttura in acciaio inox AISI 304 - coperchio superiore in policarbonato alimentare trasparente - microinterruttori di sicurezza su coperchio superiore e su bocca di uscita - pulsante espulsione prodotto - timer 0÷4 minuti - getto automatico d'acqua per favorire l'eliminazione dei residui di pulitura - **in dotazione piattello a spazzole estraibile PPC.**















EN Mussels cleaning machine. Structure in stainless steel AISI 304 - upper cover in clear alimentary polycarbonate - safety microswitches on the upper lid and on the inlet - product ejection button - timer 0÷4 minutes - automatic water jet to facilitate the elimination of peeling waste - **extractable plate with brushes PPC enclosed.**







FR Machine à laver les moules. Corps en acier Inox AISI 304 - couvercle supérieur en polycarbonate alimentaire transparent - micro-interrupteurs de sécurité sur le couvercle supérieur et sur l'orifice d'entrée - bouton d'éjection du produit - temporisateur 0÷4 minutes - jet d'eau automatique pour l'élimination des résidus - **de série plaque extractible à brosses PPC.**

DE Maschine zum Säubern von Miesmuscheln. Gehäuse aus Edelstahl AISI 304 - oberer Deckel aus durchsichtigem, lebensmitteltauglichem Polycarbonat - Sicherheitsmikroschalter am oberen Deckel und an der Einführöffnung - Produktauswurfstaste - Timer 0÷4 Minuten - automatischer Wasserstrahl zur leichteren Abreinigung - **abnehmbare PPC Platte mit Bürsten beigelegt.**

ES Máquina para lavar mejillones. Estructura de acero inoxidable AISI 304 - tapa superior de policarbonato transparente para alimentos - microinterruptores de seguridad en la tapa y la boca de salida - botón para la expulsión del producto - temporizador 0÷4 minutos - chorro de agua automático para favorecer la eliminación de los residuos de la limpieza - **en la dotación plato extraíble con cepillos PPC.**

RU Машина для очистки мидий. Корпус из нержавеющей стали AISI 304 - верхняя крышка из прозрачного поликарбоната подходит для пищевых продуктов - безопасный микровыключатель на верхней крышке и вставном отверстии - кнопка выброса продукта - таймер 0÷4 минуты - автоматическая струя воды для облегчения очистки - **съёмная пластина РРС с щетками.**

	LCN18M	LCF18M
	0,9 kW (1,2 HP)	
	230-400/3N/50Hz	
	230V/1N/50Hz	
	± 10/18 Kg max	
	220 Kg/h	
	no	si / yes
	400 x 770 x 930(h) mm	380 x 770 x 1230(h) mm
		
	41 Kg	39 Kg
	52 Kg	50 Kg
	830 x 530 x 950(h) mm	
	0,463 m <sup>3</sup>	
		

	CI	
	3,2 Kg	 4,7 Kg
	600 x 410 x 490(h) mm	 0,121 m <sup>3</sup>
	560 x 380 x 440(h) mm	



PPF5



LCF18



PPF25

Optional  
pelapatate e lavacozze

ACCESSORIES  
ACCESSOIRES  
ZUBEHÖR  
ACCESORIOS  
AKCECCYAPЫ

**PPF-LCF/5**

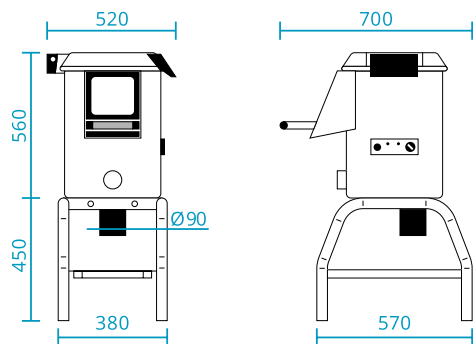

**PPF-LCF/10**

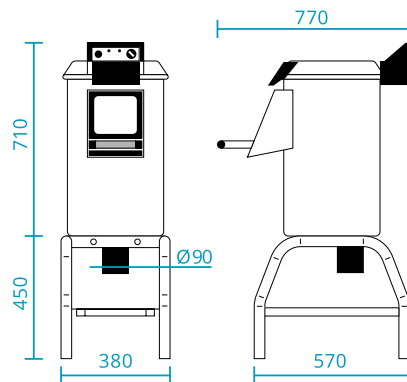

**PPF-LCF/18M**

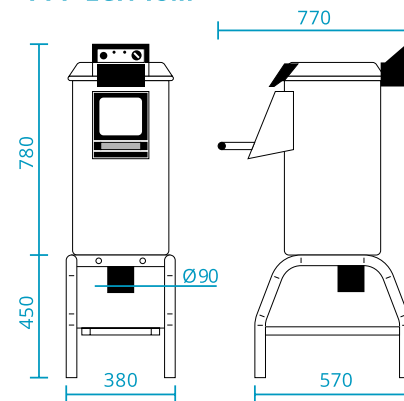

**PPF/25**

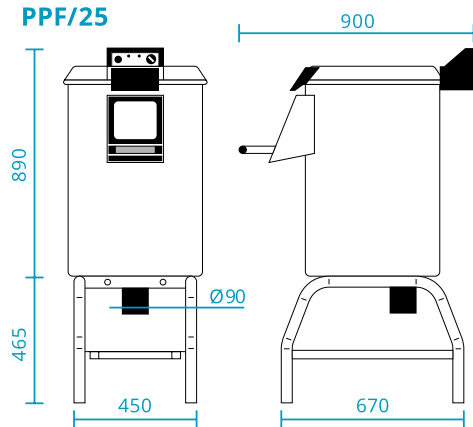

**PPN-LCF/5**

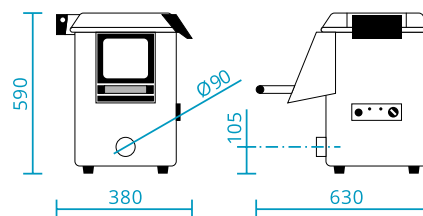

**PPN-LCN/10M**

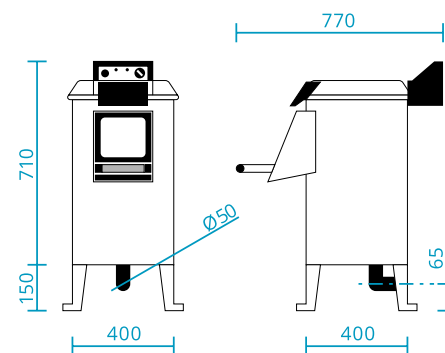

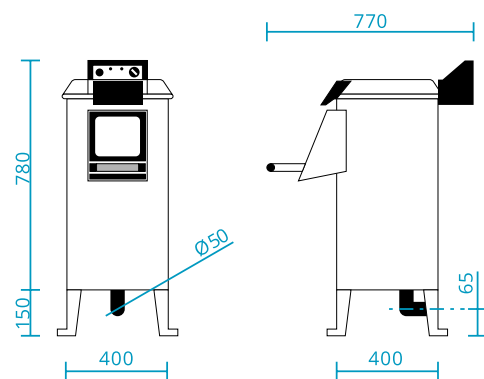

**PPN-LCN/18M**

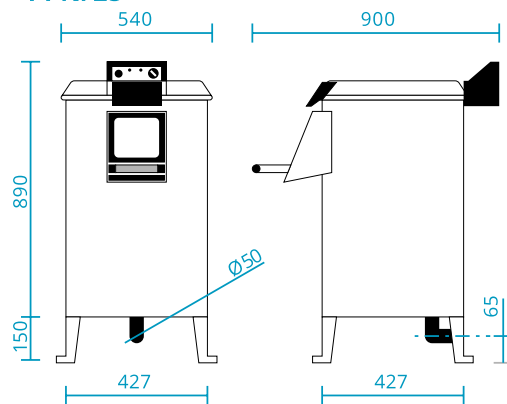

**PPN/25**



	<p>Piattello in tela abrasiva per patate Abrasive paper disk for potatoes Disque abrasif de papier pour pommes de terre Schleifscheibe für Kartoffeln Plato de tela abrasiva para patatas Абразивный диск для картофеля</p>		<p>Piattello in carborundo abrasivo per patate Potato abrasive silica carbide plate Plaque abrasive en carbure de silice pour pomme de terre Kartoffelschleifscheibe aus Siliciumcarbid Plato de carburo de silicio abrasivo para patatas Абразивный диск из карбида кремния для картофеля</p>	
Mod.	AC PTA	AC PTB	AC PAB	
	PPN 5-10-18 PPF 5-10-18	PPN 25 PPF 25	PPN 5-10-18 PPF 5-10-18	
				

	<p>Piattello a spazzole per cozze Brushing disk for mussels Plaque à brosse pour moules Scheibe mit Bürste für Miesmuscheln Plato con cepillos para mejillones Абразивный диск для мидий</p>	<p>Cestello lavaggio verdure Vegetable washing basket Panier de lavage des légumes Gemüsewaschkorb Cesta para lavar verduras Овощная корзина для мытья овощей</p>	<p>Cassetto con filtro Drawer with filter Tiroir avec filtre Schublade mit Sieb Cajón con filtro Коробка с фильтром</p>
Mod.	AC PPC	AC CCV	AC CCF
	LCN 5-10-18 LCF 5-10-18	PPN 10-18 PPF 10-18	PPF 5-10-18-25 LCF 5-10-18
			



# LAV

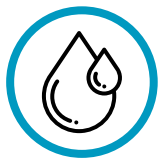

CARICO/SCARICO ACQUA  
WATER INLET / OUTLET  
ВХОД/ВЫХОД ВОДЫ



# Lavaverdure centrifuga

VEGETABLE WASHER AND DRYER  
LAVEUS À LÉGUMES ET ESSOREUSES  
GEMÜSEWASCH-UND TROCKNERMASCHINE  
LAVADORA DE VERDURAS Y CENTRIFUGADORA  
ПРИБОР ДЛЯ МОЙКИ ОВОЩЕЙ  
И СУШКИ ЛИСТЬЕВ САЛАТА

222



GUARDA IL VIDEO  
WATCH THE VIDEO

 **fimar**

IT Struttura in acciaio inox AISI 304 - coperchio superiore in policarbonato alimentare trasparente - microinterruttore di sicurezza su coperchio - filtro a cassetto e filtro su scarico vasca removibili - pompa di scarico ispezionabile dall'esterno - consumo acqua per ciclo 30/35 L circa - motore trifase a 2 velocità, una per il lavaggio e una per la centrifuga - possibilità di scelta di due cicli di lavaggio e tre tempi di durata per ogni ciclo - tasto "dry" per centrifuga manuale. Misure per il collegamento idrico richiesto 3/4".

EN Stainless steel AISI 304 casing - upper lid in clear alimentary polycarbonate - safety microswitch on the lid - removable drawer filter and filter on bowl drain - externally inspectable draining pump - water consumption per cycle approx. 30/35 L - three-phase motor with 2 speeds, one for washing and one for the centrifuge - possibility of choosing two washing cycles and three duration times for each cycle - "dry" button for manual centrifuge. Measures for the required water connection 3/4".

FR Corps en acier inox AISI 304 - couvercle supérieur en polycarbonate alimentaire transparent - micro-interrupteur de sécurité sur le couvercle - filtre à tiroir amovible et filtre sur le vidange cuve - pompe d'évacuation à inspection externe - consommation en eau par cycle 30/35 L environ - moteur à trois phases avec 2 vitesses, une pour le lavage et une pour le centrifuge - possibilité de choisir deux cycles et trois temps de lavage par cycle - bouton "dry" pour centrifuger en mode manuel. Mesures pour le raccordement d'eau nécessaire 3/4".

DE Gehäuse aus Edelstahl AISI 304 - Oberdeckel aus durchsichtigem lebensmitteleuglichem Polycarbonat - Sicherheitsmikroschalter am Deckel - herausnehmbarer Schubladensieb und Filter am Schüsselablauf - extern prüfbar Entleerungspumpe - Wasserverbrauch pro Zyklus ca. 30/35 L - Dreiphasenmotor mit 2 Geschwindigkeiten, eine für das Waschen und eine für die Zentrifuge - zwei Waschzyklen und drei Durchlaufzeitzeiten pro Zyklus möglich - Taste "dry" für manuelle Zentrifuge. Maße für den erforderlichen Wasseranschluss 3/4".

ES Estructura de acero inoxidable AISI 304 - tapa superior de policarbonato transparente para alimentos - microinterruptor de seguridad en la tapa - filtro con caja y filtro en la descarga bol extraíbles - bomba de descarga para controlar del exterior - consumo de agua por ciclo 30/35 L aproximadamente - motor trifásico de dos velocidades para lavar y para centrifugar - posibilidad de elegir entre dos ciclos de lavado y tres tiempos diferentes de duración por cada ciclo - botón "dry" para centrifugación manual. Medidas para la conexión hídrica 3/4".

RU Корпус из нержавеющей стали AISI 304 - верхняя крышка из прозрачного пищевого поликарбоната - безопасный микровыключатель на крышке - съемный выдвижной фильтр и фильтр на сливном отверстии - внешний инспектируемый дренажный насос - расход воды за цикл примерно 30/35 лт - трехфазный двигатель с 2 скоростями, один для мытья и один для центрифуги - возможность выбора двух циклов мытья вручную и трех раз в течение цикла "сухой". Мероприятия по подключению необходимого количества воды 3/4".

LAV			
	0,37 - 0,11 kW (0,5-0,15 HP)		
	400V/3N/50Hz		
	<table border="1"> <tr> <td>4 Kg verdure pesanti - heavy vegetables légumes compacts - schwere Gemüse verdura con peso - тяжелые овощи</td> <td>1,5 Kg verdure in foglia - leaf vegetables légumes en feuille - Blattgemüse verdura en hojas - листовые овощи</td> </tr> </table>	4 Kg verdure pesanti - heavy vegetables légumes compacts - schwere Gemüse verdura con peso - тяжелые овощи	1,5 Kg verdure in foglia - leaf vegetables légumes en feuille - Blattgemüse verdura en hojas - листовые овощи
4 Kg verdure pesanti - heavy vegetables légumes compacts - schwere Gemüse verdura con peso - тяжелые овощи	1,5 Kg verdure in foglia - leaf vegetables légumes en feuille - Blattgemüse verdura en hojas - листовые овощи		
	3,5/4,5'		
	± 20/25 Kg/h		
	450 rpm Centrifuga - Centrifuge - Центрифуга		
	ø 280 x 270(h) mm		
	450 x 610 x 880(h) mm		
			
	40 Kg		
	50 Kg		
	850 x 550x 1070(h) mm		
	0,500 m³		

VV300  
VV350



VV300N



VV350

# Affettatrici a volano

FLYWHEEL MANUAL SLICER  
TRANCHEUSES MANUELLES A VOLANT  
SCHWUNGRADAUFSCNITTMASCHINE  
CORTADORAS CON VOLANTE  
СЛАЙСЕРЫ С ПРИВОДОМ ОТ МАХОВИКА



IT Macchina manuale per affettare salumi. Struttura verniciata a fuoco di colore rosso o nero - anello fisso protezione lama - regolazione spessore taglio e avanzamento automatico del carrello - spessore taglio da 0 a 25 mm.  
Accessori: piedistallo in ghisa verniciato di colore rosso o nero.

EN Hand-operated machine for slicing cold cuts. Red or black painted surface - blade protection fixed ring - cutting thickness adjustment and automatic feeder advancement. Cutting thickness from 0 to 25 mm.  
Accessories: Cast iron base, painted in red or black.

FR Machine manuelle pour trancher la charcuterie. Peint en rouge ou noir - anneau fixe de protection de la lame - réglage de l'épaisseur de coupe et avancement automatique de l'alimentateur. Epaisseur de coupe de 0 à 25 mm.  
Accessoires : Base en fonte peinte en rouge ou en noir.

DE Manuelle Maschine zum Schneiden von Aufschnitt. Rot oder schwarz ofenlackierte Oberfläche - fester Schutzring für die Klängen Schnittdickeneinstellung und automatisches Wagnvorschub. Schnittdicken von 0 bis 25 mm.  
Zubehör: Standfuß aus Gusseisen, rot oder schwarz lackiert.

ES Máquina manual para cortar en lonchas embutidos, quesos, etc. Estructura pintada a fuego de color rojo o negro - anillo fijo para proteger la cuchilla - regulación espesor del corte y avance automático del carro. Espesor del corte de 0 a 25 mm.  
Accesorios: Plataforma de hierro fundido pintado de color rojo o negro.

RU Ручная машина для резки холодной нарезки. Поверхность окрашена в красный или черный цвет - фиксированное защитное кольцо для лезвий, регулировка толщины резания и автоматическая подача каретки. Толщина резания от 0 до 25 мм.  
Аксессуары: чугунная основа, окрашена в красный или черный цвет.



Cavalletto  
Base  
Support  
Gestell  
Caballete  
Подставка

VV350  
CON PIEDISTALLO  
WITH STAND

	VV300	VV350
	ø 300 mm	ø 350 mm
	260 x 190(h) mm	320 x 245(h) mm
	440 x 360 mm	660 x 550 mm
	720 x 600 x 500(h) mm	830 x 720 x 640(h) mm
	42 Kg	91 Kg
	75 Kg	123 Kg
	840 x 750 x 850(h) mm	1000 x 900 x 980(h) mm
	0,536 m <sup>3</sup>	0,882 m <sup>3</sup>

	CAVVV300	CAVVV350
	560 x 380 x 800(h) mm	730 x 600 x 800(h) mm
	71 Kg	74 Kg
	87 Kg	106 Kg
	1000 x 900 x 980(h) mm	
	0,882 m <sup>3</sup>	

ECO220  
ECO250  
ECO300



ECO220



ECO250



ECO300

Affettatrici serie ECO

ECO LINE SLICERS  
TRANCHEUSES LIGNE ECO  
AUFSCHNITTMASCHINEN SERIE ECO  
CORTADORAS LÍNEA ECO  
СЛАЙСЕРЫ ЛИНИИ "ECO"

IT Macchina per affettare salumi, formaggi, carni ecc. Struttura in lega leggera di alluminio verniciato - **blocco piatto vela** con sistema "Easy Clean" per una facile pulizia - anello fisso protezione lama - spessore taglio fino a 14÷16 mm - affilatoio fisso con coppia di smerigli per l'affilatura della lama per i modelli ECO250 - ECO300 - affilatoio amovibile incluso (inserito nel vano inferiore della macchina) per il modello ECO220.

EN Slicing machine for cold cuts, cheeses, meats, etc. Light painted aluminum alloy casing - **tray block** with "Easy Clean" system for an easier cleaning - blade protection fixed ring - cutting thickness up to 14÷16 mm - fixed sharpener with a pair of grinders to sharpen the blade for ECO250 - ECO300 models - Removable sharpener included (inserted in the lower compartment of the machine) for the ECO220 model.

FR Machine à trancher pour charcuterie, fromages, viandes, etc. Corps en alliage d'aluminium verni léger - **bloc plateau** avec système "Easy Clean" pour un nettoyage facile - anneau fixe pour la protection de la lame - épaisseur de coupe jusqu'à 14÷16 mm - affûteur fixe avec une paire de meuleuses pour affûter la lame - sur les modèles ECO250 et ECO300 - affûteur amovible inclus (inséré dans le compartiment inférieur de la machine) pour le modèle ECO220.

DE Schneidemaschine für Wurst, Käse, Fleisch, usw. Leichtes Gehäuse aus lackierter Aluminiumlegierung - **Schlittenhalterung** mit "Easy Clean"-System für einfache Reinigung - fester Ring für den Klingenschutz - Schnittdicke bis 14÷16 mm - feste Schleifvorrichtung mit einem Paar Schleifer zum Schärfen der Klinge für die Modelle ECO250 - ECO300 - abnehmbare Schleifvorrichtung im Lieferumfang enthalten (im unteren Fach der Maschine eingesetzt) für das Modell ECO220.

ES Máquina para cortar en lonchas embutidos, quesos, carnes, etc. Estructura ligera de aleación de aluminio pintado - **bloque plano** con sistema "Easy Clean" para una fácil limpieza - anillo fijo para proteger la cuchilla - espesor del corte de 14÷16 mm - afilador fijo piedras de amolar para afilar la cuchilla para los modelos ECO250 - ECO300 - afilador extraíble incluido (insertado en el compartimento inferior de la máquina) para el modelo ECO220.

RU Режущая машина для колбас, сыра, мяса и т.д... Легкий корпус из окрашенного алюминиевого сплава - **Держатель ползунков** с системой "Easy Clean" для облегчения очистки - Фиксированное кольцо для защиты полотна - Толщина резания от 14÷16 мм - Фиксированное шлифовальное устройство с парой шлифмашин для заточки полотна для моделей ECO250 - ECO300 - Съёмная заточка (вставлена в нижнюю часть станка) для модели ECO220 входит в комплект поставки.



ECO250RED

	ECO220	ECO250	ECO300
	0,14 kW (0,19 HP)		0,18 kW (0,25 HP)
	230V/1N/50Hz		
	220 mm	250 mm	300 mm
	210 x 145(h) mm	220 x 160(h) mm	200 x 205(h) mm
	400 x 250 mm		
	530 x 480 x 320(h) mm	530 x 480 x 375(h) mm	550 x 480 x 430(h) mm
			
	12,5 Kg	14 Kg	17 Kg
	14 Kg	15 Kg	19 Kg
	480 x 545 x 410(h) mm		510 x 620 x 470(h) mm
	0,107 m <sup>3</sup>		0,148 m <sup>3</sup>

#### SOLO PER MODELLO ECO250/ONLY MOD. ECO250

Disponibili su richiesta in colore rosso

Available on request in red color

Disponible sur demande en couleur rouge

Auf Anfrage in roter Farbe erhältlich.

Disponibile bajo pedido en color rojo

По запросу возможна поставка в красном цвете по запросу

ECO300L  
ECO330



ECO300L



Affettatrici serie ECO

ECO LINE SLICERS  
TRANCHEUSES LIGNE ECO  
AUFSCHNITTMASCHINEN SERIE ECO  
CORTADORAS LÍNEA ECO  
СЛАЙСЕРЫ ЛИНИИ "ECO"

IT Macchina per affettare salumi, formaggi, carni ecc. Struttura in lega leggera di alluminio verniciato - **blocco piatto vela** con sistema "Easy Clean" per una facile pulizia - anello fisso protezione lama - spessore taglio fino a 14÷16 mm - affilatoio fisso con coppia di smerigli per l'affilatura della lama.





EN Slicing machine for cold cuts, cheeses, meats, etc. Light painted aluminum alloy casing - **tray block** with "Easy Clean" system for an easier cleaning - blade protection fixed ring - cutting thickness up to 14÷16 mm - fixed sharpener with a pair of grinders to sharpen the blade.

FR Machine à trancher pour charcuterie, fromages, viandes, etc. Corps en alliage d'aluminium anodisé léger - **bloc plateau** - anneau fixe pour la protection de la lame - épaisseur de coupe de 14 à 16 mm - protège-lame extractible - bouton de réglage de la lame avec échelle graduée - affûteur fixe avec une paire de meuleuses pour affûter la lame.

DE Schneidemaschine für Wurst, Käse, Fleisch, usw. Leichtes Gehäuse aus eloxierter Aluminiumlegierung - **Schlittenhalterung** - fester Ring für den Klingenschutz - Schnittdicke von 14 bis 16 mm - abnehmbarer Klingenschutz - Klingeneinstellknopf mit abgestufter Skala - feste Schleifvorrichtung mit einem Paar Schleifer zum Schärfen der Klinge.

ES Máquina para cortar en lonchas embutidos, quesos, carnes, etc. Estructura ligera de aleación de aluminio anodizado - **bloque plano** - protección vertical - espesor del corte de 14÷16 mm - anillo fijo para proteger la cuchilla y protección de la cuchilla extraíble - pomo de regulación protección vertical con escala graduada - afilador fijo piedras de amolar para afilar la cuchilla.

RU Режущая машина для колбас, сыра, мяса и т.д. Легкий корпус из анодированного алюминиевого сплава - **Держатель ползунков** - Фиксированное кольцо для защиты полотна - Толщина резания от 14 до 16 мм - Съёмная защита полотна - Регулятор регулировки полотна с градуированной шкалой - Фиксированноешлифовальноеустройство спаройшлифмашиной для заточки полотна.

	ECO300L	ECO330
	0,18 kW (0,25 HP)	
 1 Ph	230V/1N/50Hz	
 mm	300 mm	330 mm
 mm	245 x 195(h) mm	230 x 210(h) mm
 mm	440 x 290 mm	
 mm	605 x 480 x 460(h) mm	630 x 525 x 480(h) mm
		
 Kg	24 Kg	27 Kg
 Kg	26 Kg	30 Kg
 mm	530 x 630 x 480(h) mm	570 x 740 x 515(h) mm
 m <sup>3</sup>	0,16 m <sup>3</sup>	0,22 m <sup>3</sup>

H220N  
H250N  
H275N



H250N

Affettatrici a gravità  
con lama da 220 a 275 mm

GRAVITY SLICERS  
TRANCHEUSES A GRAVITE  
SCHRÄGE AUFSCHNITTMASCHINEN  
CORTADORAS POR GRAVEDAD  
ГРАВИТАЦИОННЫЕ СЛАЙСЕРЫ

- IT Macchina per affettare salumi, formaggi, carni ecc. Struttura in lega leggera di alluminio anodizzato - **blocco piatto vela** - anello fisso protezione lama - spessore taglio da 0 a 15 mm - paralama estraibile - pomello regolazione vela con scala graduata - affilatoio fisso con coppia di smerigli per l'affilatura della lama.
- EN Slicing machine for cold cuts, cheeses, meats, etc. Light anodized aluminum alloy casing - **tray block** - blade protection fixed ring - cutting thickness from 0 to 15 mm - extractable blade guard - blade adjustment knob with graduated scale - fixed sharpener with a pair of grinders to sharpen the blade.
- FR Machine à trancher pour charcuterie, fromages, viandes, etc. Corps en alliage d'aluminium anodisé léger - **bloc plateau** - anneau fixe pour la protection de la lame - épaisseur de coupe de 0 à 15 mm - protège-lame extractible - bouton de réglage de la lame avec échelle graduée - affûteur fixe avec une paire de meuleuses pour affûter la lame.
- DE Schneidemaschine für Wurst, Käse, Fleisch, usw. Leichtes Gehäuse aus eloxierter Aluminiumlegierung - **Schlittenhalterung** - fester Ring für den Klingenschutz - Schnittstärke von 0 bis 15 mm - abnehmbarer Klingenschutz - Klingeneinstellknopf mit abgestufter Skala - feste Schleifvorrichtung mit einem Paar Schleifer zum Schärfen der Klinge.
- ES Máquina para cortar en lonchas embutidos, quesos, carnes, etc. Estructura ligera de aleación de aluminio anodizado - **bloque plano** - protección vertical - espesor del corte de 0÷15 mm - anillo fijo para proteger la cuchilla y protección de la cuchilla extraíble - pomo de regulación protección vertical con escala graduada - afilador fijo piedras de amolar para afilar la cuchilla.
- RU Режущая машина для колбас, сыра, мяса и т.д. Легкий корпус из анодированного алюминиевого сплава - **Держатель ползунков** - Фиксированное кольцо для защиты полотна - Толщина резания от 0 до 15 мм - Съёмная защита полотна - Регулятор регулировки полотна с градуированной шкалой - Фиксированное шлифовальное устройство с парой шлифмашин для заточки полотна.

	H220N	H250N	H275N
	0,18 kW (0,25 HP)	0,23 kW (0,3 HP)	
	230V/1N/50Hz		
	220 mm	250 mm	275 mm
	190 x 160(h) mm	220 x 190(h) mm	220 x 210(h) mm
	410 x 290 mm	450 x 300 mm	
	580 x 405 x 340(h) mm	620 x 425 x 370(h) mm	620 x 440 x 390(h) mm
			
	14 Kg	17 Kg	18 Kg
	16 Kg	19 Kg	20 Kg
	490 x 470 x 400(h) mm	540 x 460 x 450(h) mm	
	0,092 m <sup>3</sup>	0,112 m <sup>3</sup>	

H300N  
H330  
H350  
H370



H300N









H350

Affettatrici a gravità  
con lama da 300 a 370 mm

GRAVITY SLICERS  
TRANCHEUSES A GRAVITE  
SCHRÄGE AUFSCHNITTMASCHINEN  
CORTADORAS POR GRAVEDAD  
ГРАВИТАЦИОННЫЕ СЛАЙСЕРЫ



- IT Macchina per affettare salumi, formaggi, carni ecc. Struttura in lega leggera di alluminio anodizzato - **blocco piatto vela** - anello fisso protezione lama - spessore taglio da 0 a 15 mm - paralama estraibile - pomello regolazione vela con scala graduata - affilatoio fisso con coppia di smerigli per l'affilatura della lama.
- EN Slicing machine for cold cuts, cheeses, meats, etc. Light anodized aluminum alloy casing - **tray block** - blade protection fixed ring - cutting thickness from 0 to 15 mm - extractable blade guard - blade adjustment knob with graduated scale - fixed sharpener with a pair of grinders to sharpen the blade.
- FR Machine à trancher pour charcuterie, fromages, viandes, etc. Corps en alliage d'aluminium anodisé léger - **bloc plateau** - anneau fixe pour la protection de la lame - épaisseur de coupe de 0 à 15 mm - protège-lame extractible - bouton de réglage de la lame avec échelle graduée - affûteur fixe avec une paire de meuleuses pour affûter la lame.
- DE Schneidemaschine für Wurst, Käse, Fleisch, usw. Leichtes Gehäuse aus eloxierter Aluminiumlegierung - **Schlittenhalterung** - fester Ring für den Klingenschutz - Schnittdicke von 0 bis 15 mm - abnehmbarer Klingenschutz - Klingeneinstellknopf mit abgestufter Skala - feste Schleifvorrichtung mit einem Paar Schleifer zum Schärfen der Klinge.
- ES Máquina para cortar en lonchas embutidos, quesos, carnes, etc. Estructura ligera de aleación de aluminio anodizado - **bloque plano** - protección vertical - espesor del corte de 0÷15 mm - anillo fijo para proteger la cuchilla y protección de la cuchilla extraíble - pomo de regulación protección vertical con escala graduada - afilador fijo piedras de amolar para afilar la cuchilla.
- RU Режущая машина для колбас, сыра, мяса и т.д. Легкий корпус из анодированного алюминиевого сплава - **Держатель ползунков** - Фиксированное кольцо для защиты полотна - Толщина резания от 0 до 15 мм - Съёмная защита полотна - Регулятор регулировки полотна с градуированной шкалой - Фиксированное шлифовальное устройство с парой шлифмашин для заточки полотна.

	H300N	H330	H350	H370
	0,26 kW (0,35 HP)	0,37 kW (0,5 HP)		
	230-400V/3/50Hz			
	230V/1N/50Hz			
	300 mm	330 mm	350 mm	370 mm
	220 x 220(h) mm	260 x 235(h) mm	310 x 260(h) mm	300 x 275(h) mm
	480 x 350 mm	550 x 410 mm	600 x 430 mm	
	650 x 495 x 440(h) mm	770 x 550 x 465(h) mm	890 x 585 x 480(h) mm	
				
	24 Kg	32 Kg	36 Kg	37 Kg
	27 Kg	43 Kg	52 Kg	53 Kg
	640 x 520 x 490(h) mm	700 x 650 x 640(h) mm	800 x 730 x 670(h) mm	
	0,163 m <sup>3</sup>	0,291 m <sup>3</sup>	0,391 m <sup>3</sup>	

# HL300



HL300

Affettatrici a gravità  
con corsa lunga

GRAVITY SLICERS  
TRANCHEUSES A GRAVITE  
SCHRÄGE AUFSCNITTMASCHINEN  
CORTADORAS POR GRAVEDAD  
ГРАВИТАЦИОННЫЕ СЛАЙСЕРЫ

IT Macchina per affettare salumi, formaggi, carni ecc. Struttura in lega leggera di alluminio anodizzato - **blocco piatto vela** - corsa lunga - spessore taglio da 0÷15 mm - anello fisso protezione lama - paralama estraibile - pomello regolazione vela con scala graduata - affilatoio fisso con coppia di smerigli per l'affilatura della lama.













EN Slicing machine for cold cuts, cheeses, meats, etc. Light anodized aluminum alloy casing - **tray block** - long stroke - blade protection fixed ring - cutting thickness from 0 to 15 mm - extractable blade guard - blade adjustment knob with graduated scale - fixed sharpener with a pair of grinders to sharpen the blade.

FR Machine à trancher pour charcuterie, fromages, viandes, etc. Corps en alliage d'aluminium anodisé léger - **bloc plateau** - longue course - anneau fixe pour la protection de la lame - épaisseur de coupe de 0 à 15 mm - protège-lame extractible - bouton de réglage de la lame avec échelle graduée - affûteur fixe avec une paire de meuleuses pour affûter la lame.

DE Schneidemaschine für Wurst, Käse, Fleisch, usw. Leichtes Gehäuse aus eloxierter Aluminiumlegierung - **Schlittenhalterung** - fester Ring für den Klingenschutz - Langschub - Schnittdicke von 0 bis 15 mm - abnehmbarer Klingenschutz - Klingeneinstellknopf mit abgestufter Skala - feste Schleifvorrichtung mit einem Paar Schleifer zum Schärfen der Klinge.

ES Máquina para cortar en lonchas embutidos, quesos, carnes, etc. Estructura ligera de aleación de aluminio anodizado - **bloque plano** - protección vertical - carrera larga - espesor del corte de 0÷15 mm - anillo fijo para proteger la cuchilla y protección de la cuchilla extraíble - pomo de regulación protección vertical con escala graduada - afilador fijo piedras de amolar para afilar la cuchilla.

RU Режущая машина для колбас, сыра, мяса и т.д. Легкий корпус из анодированного алюминиевого сплава - **Держатель ползунков** - длиной хода - Фиксированное кольцо для защиты полотна - Толщина резания от 0 до 15 мм - Съёмная защита полотна - Регулятор регулировки полотна с градуированной шкалой - Фиксированное шлифовальное устройство с парой шлифмашин для заточки полотна.

	<b>HL300</b>
	0,37 kW (0,5 HP)
	230-400V/3/50Hz
	230V/1N/50Hz
	300 mm
	260 x 220(h) mm
	550 x 410 mm
	770 x 540 x 460(h) mm
	
	31 Kg
	42 Kg
	700 x 650 x 640(h) mm
	0,291 m³

# HR250 HR300N



HR300N

Affettatrici  
compatte

COMPACT SLICERS  
TRANCHEUSES COMPACTES  
KOMPACTE AUFSCHNITTMASCHINEN  
CORTADORAS COMPACTAS  
КОМПАКТНЫЙ ЛОМТИК

IT Macchina per affettare salumi, formaggi, carni ecc. Struttura in lega leggera di alluminio anodizzato - **blocco piatto vela** - modelli compatti - spessore taglio da 0÷15 mm - anello fisso protezione lama - paralama estraibile - pomello regolazione vela con scala graduata - affilatoio fisso con coppia di smerigli per l'affilatura della lama.

EN Slicing machine for cold cuts, cheeses, meats, etc. Light anodized aluminum alloy casing - **tray block** - compact models - blade protection fixed ring - cutting thickness from 0 to 15 mm - extractable blade guard - blade adjustment knob with graduated scale - fixed sharpener with a pair of grinders to sharpen the blade.

FR Machine à trancher pour charcuterie, fromages, viandes, etc. Corps en alliage d'aluminium anodisé léger - **bloc plateau** - longue course - anneau fixe pour la protection de la lame - épaisseur de coupe de 0 à 15 mm - protège-lame extractible - bouton de réglage de la lame avec échelle graduée - affûteur fixe avec une paire de meuleuses pour affûter la lame.

DE Schneidemaschine für Wurst, Käse, Fleisch, usw. Leichtes Gehäuse aus eloxierter Aluminiumlegierung - **Schlittenhalterung** - fester Ring für den Klingenschutz - Kompaktmodelle - Schnittdicke von 0 bis 15 mm - abnehmbarer Klingenschutz - Klingeneinstellknopf mit abgestufter Skala - feste Schleifvorrichtung mit einem Paar Schleifer zum Schärfen der Klinge.

ES Máquina para cortar en lonchas embutidos, quesos, carnes, etc. Estructura ligera de aleación de aluminio anodizado - **bloque plano** - protección vertical - modelos compactos - espesor del corte de 0÷15 mm - anillo fijo para proteger la cuchilla y protección de la cuchilla extraíble - pomo de regulación protección vertical con escala graduada - afilador fijo piedras de amolar para afilar la cuchilla.

RU Режущая машина для колбас, сыра, мяса и т.д. Корпус из легкого анодированного алюминиевого сплава - **держатель скольжения** - фиксированное кольцо для защиты ножей - компактные модели - толщина реза от 0 до 15 мм - съемная защита ножей - ручка регулировки ножей с градуированной шкалой - фиксированное шлифовальное устройство с парой шлифмашин для заточки ножей.

	HR250	HR300N
	0,18 kW (0,25 HP)	0,23 kW (0,3 HP)
	230V/1N/50Hz	
	250 mm	300 mm
	190 x 190(h) mm	220 x 210(h) mm
	410 x 290 mm	450 x 300 mm
	620 x 425 x 370(h) mm	
		
	15 Kg	20 Kg
	17 Kg	24 Kg
	540 x 460 x 450(h) mm	640 x 520 x 490(h) mm
	0,112 m³	0,163 m³

V250  
VR300N  
VM300



VR300N

Affettatrici verticali  
con carrello removibile

VERTICAL SLICERS  
TRANCHEUSES VERTICALES  
VERTIKALE AUFSCHNITTMASCHINE  
CORTADORAS VERTICALES  
ВЕРТИКАЛЬНЫЕ СЛАЙСЕРЫ

IT Macchina per affettare salumi, carne, formaggi, ecc. Struttura in lega leggera di alluminio anodizzato - **blocco piatto vela** per rimozione carrello - disponibili con piatto carne (escluso mod. V250) - spessore taglio 0÷16 mm - anello fisso protezione lama - paralama estraibile - pomello regolazione vela con scala graduata - affilatoio fisso con coppia di smerigli per l'affilatura della lama.

EN Slicing machine for cold cuts, cheeses, meats, etc. Light anodized aluminum alloy casing - **tray block** for table removing - also available with sliding meat table (model V250 excluded) - blade protection fixed ring - cutting thickness from 0 to 16 mm - extractable blade guard - blade adjustment knob with graduated scale - fixed sharpener with a pair of grinders to sharpen the blade.

FR Machine à trancher pour charcuterie, fromages, viandes, etc. Corps en alliage d'aluminium anodisé léger - **bloc plateau** pour l'enlèvement du plateau - également disponible avec plateau à viande coulissant (modèle V250 exclu) - anneau fixe pour la protection de la lame - épaisseur de coupe de 0 à 16 mm - protège-lame extractible - bouton de réglage de la lame avec échelle graduée - affûteur fixe avec une paire de meuleuses pour affûter la lame.

DE Schneidemaschine für Wurst, Käse, Fleisch, usw...Leichtes Gehäuse aus eloxierter Aluminiumlegierung - **Schlittenhalterung** für sichere Entnahmefester Ring für den Klingenschutz - auch mit Fleischschlitten erhältlich (außer Modell V250) - Schnittdicke von 0 bis 16 mm - abnehmbarer Klingenschutz - Klingeneinstellknopf mit abgestufter Skala - feste Schleifvorrichtung mit einem Paar Schleifer zum Schärfen der Klinge.

ES Máquina para cortar en lonchas embutidos, quesos, carnes, etc. Estructura ligera de aleación de aluminio anodizado - **bloque plano** - protección vertical para quitar el carro - disponibles con plato carne (excluido modelo V250) - espesor del corte de 0÷16 mm - anillo fijo para proteger la cuchilla y protección de la cuchilla extraíble - pomo de regulación protección vertical con escala graduada - afilador fijo piedras de amolar para afilar la cuchilla.

RU Режущая машина для колбас, сыра, мяса и т.д...Корпус из легкого анодированного алюминиевого сплава - **держатель скольжения** - фиксированное кольцо для защиты ножей - также предлагается с раздвижным мясным столом (исключая модель V250) - толщина реза от 0 до 16 мм - съемная защита ножей - ручка регулировки ножей с градуированной шкалой - фиксированное шлифовальное устройство с парой шлифмашин для заточки ножей.



	V250	VR300N	VM300
	0,26 kW (0,35 HP)		
	-	230-400V/3/50Hz	
	230V/1N/50Hz		
	250 mm	300 mm	
	240 x 170(h) mm	240 x 195(h) mm	260 x 190(h) mm
	470 x 370 mm		495 x 360 mm
	530 x 430 x 500(h) mm	610 x 520 x 520(h) mm	650 x 500 x 460(h) mm
			
	24 Kg	27,6 Kg	35 Kg
	34 Kg	40 Kg	43 Kg
	700 x 630 x 630(h) mm	700 x 630 x 700(h) mm	550 x 670 x 550(h) mm
	0,278 m³	0,309 m³	0,203 m³

#### ESCLUSO MOD. V250 / MODEL V250 EXCLUDED / ИСКЛЮЧАЯ МОДЕЛЬ V250

\* Disponibili con piatto carne allo stesso prezzo.  
Available with meat table at the same price.  
Disponibile avec plateau à viande au même prix.  
Erhältlich mit Fleischschlitten zum gleichen Preis.  
Disponibles con plato para carne al mismo precio.  
Доступны с лотком для мяса по той же цене.

V330  
V350  
V370



V350



V370

# Affettatrici verticali con carrello removibile

VERTICAL SLICERS  
TRANCHEUSES VERTICALES  
VERTIKALE AUFSCHNITTMASCHINE  
CORTADORAS VERTICALES  
ВЕРТИКАЛЬНЫЕ СЛАЙСЕРЫ



IT Macchina per affettare salumi, carne, formaggi, ecc. Struttura in lega leggera di alluminio anodizzato - **blocco piatto vela** per rimozione carrello - disponibili con piatto carne - spessore taglio 0÷16 mm - anello fisso protezione lama - paralama estraibile - pomello regolazione vela con scala graduata - affilatoio fisso con coppia di smerigli per l'affilatura della lama.

EN Slicing machine for cold cuts, cheeses, meats, etc. Light anodized aluminum alloy casing - **tray block** for table removing - also available with sliding meat table - blade protection fixed ring - cutting thickness from 0 to 16 mm - extractable blade guard - blade adjustment knob with graduated scale - fixed sharpener with a pair of grinders to sharpen the blade.

FR Machine à trancher pour charcuterie, fromages, viandes, etc. Corps en alliage d'aluminium anodisé léger - **bloc plateau** pour l'enlèvement du plateau - également disponible avec plateau à viande coulissant - anneau fixe pour la protection de la lame - épaisseur de coupe de 0 à 16 mm - protège-lame extractible - bouton de réglage de la lame avec échelle graduée - affûteur fixe avec une paire de meuleuses pour affûter la lame.

DE Schneidemaschine für Wurst, Käse, Fleisch, usw.. Leichtes Gehäuse aus eloxierter Aluminiumlegierung - **Schlittenhalterung** für sichere Entnahme- fester Ring für den Klingenschutz - auch mit Fleischschlitten erhältlich - Schnittstärke von 0 bis 16 mm - abnehmbarer Klingenschutz - Klingeneinstellknopf mit abgestufter Skala - feste Schleifvorrichtung mit einem Paar Schleifer zum Schärfen der Klinge.

ES Máquina para cortar en lonchas embutidos, quesos, carnes, etc. Estructura ligera de aleación de aluminio anodizado - **bloque plano** - protección vertical para quitar el carro - disponibles con plato carne - espesor del corte de 0÷16 mm - anillo fijo para proteger la cuchilla y protección de la cuchilla extraíble - pomo de regulación protección vertical con escala graduada - afilador fijo piedras de amolar para afilar la cuchilla.

RU Режущая машина для колбас, сыра, мяса и т.д.. Корпус из легкого анодированного алюминиевого сплава - **держатель скольжения** - фиксированное кольцо для защиты ножей - также предлагается с раздвижным мясным столом - толщина реза от 0 до 16 мм - съемная защита ножей - ручка регулировки ножей с градуированной шкалой - фиксированное шлифовальное устройство с парой шлифмашин для заточки ножей.

	V330	V350	V370
	0,37 kW (0,5 HP)		
	230-400V/3/50Hz		
	230V/1N/50Hz		
	330 mm	350 mm	370 mm
	300 x 230(h) mm	310 x 240(h) mm	330 x 260(h) mm
	575 x 435 mm		
	790 x 650 x 560(h) mm	790 x 650 x 570(h) mm	790 x 650 x 580(h) mm
			
	43 Kg	44 Kg	45 Kg
	53 Kg	54 Kg	55 Kg
	650 x 800 x 610(h) mm		
	0,317 m³		



\* Disponibili con piatto carne allo stesso prezzo.  
Available with meat table at the same price.  
Disponible avec plateau à viande au même prix.  
Erhältlich mit Fleischschlitten zum gleichen Preis.  
Disponibles con plato para carne al mismo precio.  
Доступны с лотком для мяса по той же цене.

K300  
K330  
K350  
K370



K330



K350

# Affettatrici verticali con carrello fisso

VERTICAL SLICERS  
TRANCHEUSES VERTICALES  
VERTIKALE AUFSCHNITTMASCHINE  
CORTADORAS VERTICALES  
ВЕРТИКАЛЬНЫЕ СЛАЙСЕРЫ

IT Macchina per affettare salumi, carne, formaggi ecc. Struttura in lega leggera di alluminio anodizzato - carrello fisso - disponibili con piatto carne - anello fisso protezione lama - spessore taglio 0÷15 mm - paralama estraibile - pomello regolazione vela con scala graduata - affilatoio fisso con coppia di smerigli per l'affilatura della lama.

EN Slicing machine for cold cuts, cheeses, meats, etc. Light anodized aluminum alloy casing - also available with sliding meat table - blade protection fixed ring - cutting thickness from 0 to 15 mm - extractable blade guard - blade adjustment knob with graduated scale - fixed sharpener with a pair of grinders to sharpen the blade.

FR Machine à trancher pour charcuterie, fromages, viandes, etc. Corps en alliage d'aluminium anodisé léger - également disponible avec plateau à viande coulissant - anneau fixe pour la protection de la lame - épaisseur de coupe de 0 à 15 mm - protège-lame extractible - bouton de réglage de la lame avec échelle graduée - affûteur fixe avec une paire de meuleuses pour affûter la lame.

DE Käse, Fleisch, usw. Leichtes Gehäuse aus eloxierter Aluminiumlegierung - Schlittenhalterung für sichere Entnahmefester Ring für den Klingenschutz - auch mit Fleischschlitten erhältlich - Schnittdicke von 0 bis 15 mm - abnehmbarer Klingenschutz - Klingeneinstellknopf mit abgestufter Skala - feste Schleifvorrichtung mit einem Paar Schleifer zum Schärfen der Klinge.

ES Máquina para cortar en lonchas embutidos, quesos, carnes, etc. Estructura ligera de aleación de aluminio anodizado - protección vertical - plato fijo - disponibles con plato carne - espesor del corte de 0÷15 mm - anillo fijo para proteger la cuchilla y protección de la cuchilla extraíble - pomo de regulación protección vertical con escala graduada - afilador fijo piedras de amolar para afilar la cuchilla.

RU Режущая машина для колбас, сыра, мяса и т.д.. Корпус из легкого анодированного алюминиевого сплава - фиксированное кольцо для защиты ножей - также предлагается с раздвижным мясным столом - толщина реза от 0 до 15 мм - съемная защита ножей - ручка регулировки ножей с градуированной шкалой - фиксированное шлифовальное устройство с парой шлифмашин для заточки ножей.

	K300	K330	K350	K370
	0,37 kW (0,5 HP)			
	230-400V/3/50Hz			
	230V/1N/50Hz			
	300 mm	330 mm	350 mm	370 mm
	260 x 200(h) mm	250 x 210(h) mm	300 x 265(h) mm	290 x 275(h) mm
	570 x 470 mm		660 x 540 mm	
	710 x 550 x 610(h) mm		820 x 650 x 640(h) mm	
				
	35 Kg	36 Kg	43 Kg	46 Kg
	47 Kg	48 Kg	55 Kg	58 Kg
	700 x 620 x 700(h) mm		820 x 720 x 760(h) mm	
	0,304 m³		0,449 m³	



\* Disponibili con piatto carne allo stesso prezzo.  
Available with meat table at the same price.  
Disponibles avec plateau à viande au même prix.  
Erhältlich mit Fleischschlitten zum gleichen Preis.  
Disponibles con plato para carne al mismo precio.  
Доступны с лотком для мяса по той же цене.

CAM300T  
CAM400T  
CAM500T



CAM500T

# Macchine sottovuoto a campana serie top

CHAMBER VACUUM PACKERS  
MACHINES SOUS VIDE À CLOCHE  
KAMMER-VAKUUMVERPACKER  
ENVASADORAS AL VACÍO  
КОЛПАКОВЫЕ ВАКУУМНЫЕ  
УПАКОВОЧНЫЕ МАШИНЫ

244



GUARDA IL VIDEO  
WATCH THE VIDEO

 **fimar**

IT Macchina per prolungare i tempi di conservazione degli alimenti mantenendone intatte le caratteristiche organolettiche e impedendone la proliferazione batterica a basse temperature. Carcassa e vasca interna in acciaio inox AISI 304 - vasca con angoli arrotondati - coperchio in plexiglass - apertura automatica del coperchio a fine ciclo - pannello comandi LCD con 20 programmi memorizzabili - funzione di pulizia olio in pompa e soft air inseriti di serie - sistema di saldatura a pistoni con barra saldante estraibile senza cavi - predisposizione per immissione gas inerte - pompa BUSH (made in Germany) - funzioni step vac ed extra vacuum incluse.

**Modelli da banco.**

EN Machine aimed at prolonging food preservation times, keeping intact the organoleptic characteristics and preventing the proliferation of bacteria at low temperatures. Stainless steel AISI 304 casing and internal bowl - bowl with rounded corners - plexiglass lid - automatic lid opening at the end of the cycle - LCD control panel with 20 storable programs - oil cleaning function in the pump and soft air function standard included. - piston sealing system with removable sealing bar without cables - provision for inert gas injection - BUSH pump (made in Germany) - "step vac" and "extra vacuum" functions included. **Countertop models.**











FR Machine pour prolonger les temps de conservation des aliments, maintenir intactes les caractéristiques organoleptiques et empêcher la prolifération des bactéries à basse température. Corps et cuve intérieure en acier Inox AISI 304 - cuve avec coins arrondis - couvercle en plexiglas - ouverture automatique du couvercle en fin de cycle - panneau de commande LCD avec 20 programmes mémorisables - fonction de nettoyage de l'huile dans la pompe et fonction soft air standard incluse. - Système d'étanchéité de piston avec barre de soudure amovible sans câble - prédisposition d'injection de gaz inerte - pompe BUSH (fabriquée en Allemagne) - fonctions "step vac" et "extra vacuum" incluses. **Modèles de table.**

DE Maschine zur Verlängerung der Haltbarkeit von Lebensmitteln, die die organoleptischen Eigenschaften intakt hält und die Vermehrung von Bakterien bei niedrigen Temperaturen verhindert. Gehäuse und Innenschüssel aus Edelstahl AISI 304 - Schüssel mit abgerundeten Ecken - Plexiglasdeckel - automatische Deckelöffnung am Zyklusende - LCD-Bedienfeld mit 20 speicherbaren Programmen - Ölreinigungsfunktion in der Pumpe und Softair-Funktion serienmäßig eingebaut. - Kabelloses Kolbendichtungssystem mit abnehmbarer Schweißleiste - Schutzgaseinspritzung vorgesehen - BUSH-Pumpe (made in Germany) - Funktionen "Step Vac" und "Extra Vakuum" inklusive. **Tischmodelle.**

ES Máquina para prolongar el tiempo de conservación de los alimentos manteniendo intactas sus características organolépticas y evitando la proliferación bacteriana a bajas temperaturas. Carcasa y bol interior de acero inoxidable AISI 304 - bol interior con esquinas redondeadas - tapa en plexiglas - apertura automática de la tapa al final del ciclo - panel de control LCD con 20 programas que se pueden memorizar - función de limpieza del aceite en la bomba y "soft air" de serie - soldadura con pistones con barra de sellado extraíble y sin cables - equipada para la inyección del gas inerte - bomba BUSH (hecha en Alemania) - funciones de "step vac" y "extra vac" incluidas. **Modelos de mostrador.**

RU Машина предназначена для продления сроков хранения продуктов питания, сохранения organoleptических свойств и предотвращения размножения бактерий при низких температурах. Корпус из нержавеющей стали AISI 304 и внутренняя чаша - чаша с закругленными углами - крышка из оргстекла - автоматическое открытие крышки в конце цикла - LCD панель управления с 20 сохраняемыми программами - функция очистки масла в насосе и функция мягкого воздуха входит в стандартный комплект поставки. - система поршневого уплотнения со съемной уплотнительной планкой без кабеля - возможность впрыска инертного газа - насос BUSH (немецкого производства) - функция "ступенчатого отпуска" и "дополнительной вакцины" включены.

**Модели столешниц.**

	CAM300T	CAM400T	CAM500T
	0,75 kW (1 HP)	1,1 kW (1,5 HP)	
 1 Ph	230V/1N/50-60Hz		
BARRA SALDANTE/ HOT-WELD SEALER	300 mm	400 mm	500 mm
POMPA VUOTO/ VACUUM PUMP	8 m <sup>3</sup> /h	18 m <sup>3</sup> /h	20 m <sup>3</sup> /h
VUOTO MAX OTTENIBILE/ MAX ACHIEVABLE VACUUM	98%		
 mm	310 x 350 x 190(h) mm	410 x 450 x 220(h) mm	520 x 520 x 220(h) mm
 mm	410 x 460 x 430(h) mm	510 x 560 x 450(h) mm	610 x 630 x 500(h) mm
			
 NET Kg	38 Kg	60 Kg	72 Kg
 GROSS Kg	44 Kg	67 Kg	79 Kg
 mm	470 x 550 x 680(h) mm	600 x 650 x 680(h) mm	700 x 700 x 720(h) mm
 m <sup>3</sup>	0,176 m <sup>3</sup>	0,265 m <sup>3</sup>	0,353 m <sup>3</sup>

\* Utilizzare solo buste per sottovuoto lisce.

Use only smooth vacuum bags.

N'utilisez que des sachets sous vide lisses.

Nur glatte Vakuum-Beutel benutzen.

Use sólo bolsas de vacío lisas.

Использовать только гладкие пакеты для вакуума.

CAM500TC  
CAM700TC  
CAM900TC



CAM700TC

# Macchine sottovuoto a campana serie top

CHAMBER VACUUM PACKERS  
MACHINES SOUS VIDE À CLOCHE  
KAMMER-VAKUUMVERPACKER  
ENVASADORAS AL VACÍO  
КОЛПАКОВЫЕ ВАКУУМНЫЕ  
УПАКОВОЧНЫЕ МАШИНЫ

IT Macchina per prolungare i tempi di conservazione degli alimenti mantenendone intatte le caratteristiche organolettiche e impedendone la proliferazione batterica a basse temperature. Carcassa e vasca interna in acciaio inox AISI 304 - vasca con angoli arrotondati - coperchio in plexiglass - apertura automatica del coperchio a fine ciclo - pannello comandi LCD con 20 programmi memorizzabili - funzione di pulizia olio in pompa e soft air inseriti di serie - sistema di saldatura a pistoni con barra saldante estraibile senza cavi - predisposizione per immissione gas inerte - pompa BUSH (made in Germany) - funzioni step vac ed extra vacuum incluse.

**Modelli carrellati.**















EN Machine aimed at prolonging food preservation times, keeping intact the organoleptic characteristics and preventing the proliferation of bacteria at low temperatures. Stainless steel AISI 304 casing and internal bowl - bowl with rounded corners - plexiglass lid - automatic lid opening at the end of the cycle - LCD control panel with 20 storable programs - oil cleaning function in the pump and soft air function standard included. - piston sealing system with removable sealing bar without cables - provision for inert gas injection - BUSH pump (made in Germany) - "step vac" and "extra vacuum" functions included. **Wheeled models.**

FR Machine pour prolonger les temps de conservation des aliments, maintenir intactes les caractéristiques organoleptiques et empêcher la prolifération des bactéries à basse température. Corps et cuve intérieure en acier Inox AISI 304 - cuve avec coins arrondis - couvercle en plexiglas - ouverture automatique du couvercle en fin de cycle - panneau de commande LCD avec 20 programmes mémorisables - fonction de nettoyage de l'huile dans la pompe et fonction soft air standard incluse. - Système d'étanchéité de piston avec barre de soudure amovible sans câble - prédisposition d'injection de gaz inerte - pompe BUSH (fabriquée en Allemagne) - fonctions "step vac" et "extra vacuum" incluses. **Modèles à roues.**

DE Maschine zur Verlängerung der Haltbarkeit von Lebensmitteln, die die organoleptischen Eigenschaften intakt hält und die Vermehrung von Bakterien bei niedrigen Temperaturen verhindert. Gehäuse und Innenschüssel aus Edelstahl AISI 304 - Schüssel mit abgerundeten Ecken - Plexiglasdeckel - automatische Deckelöffnung am Zyklusende - LCD-Bedienfeld mit 20 speicherbaren Programmen - Ölreinigungsfunktion in der Pumpe und Softair-Funktion serienmäßig eingebaut. - Kabelloses Kolbendichtungssystem mit abnehmbarer Schweißleiste - Schutzgaseinspritzung vorgesehen - BUSH-Pumpe (made in Germany) - Funktionen "Step Vac" und "Extra Vakuum" inklusive. **Modelle auf Rädern.**

ES Máquina para prolongar el tiempo de conservación de los alimentos manteniendo intactas sus características organolépticas y evitando la proliferación bacteriana a bajas temperaturas. Carcasa y bol interior de acero inoxidable AISI 304 - bol interior con esquinas redondeadas - tapa en plexiglas - apertura automática de la tapa al final del ciclo - panel de control LCD con 20 programas que se pueden memorizar - función de limpieza del aceite en la bomba y "soft air" de serie - soldadura con pistones con barra de sellado extraíble y sin cables - equipada para la inyección del gas inerte - bomba BUSH (hecha en Alemania) - funciones de "step vac" y "extra vac" incluidas. **Modelos con carro.**

RU Машина предназначена для продления сроков хранения продуктов питания, сохранения organoleptических свойств и предотвращения размножения бактерий при низких температурах. Корпус из нержавеющей стали AISI 304 и внутренняя чаша - чаша с закругленными углами - крышка из оргстекла - автоматическое открытие крышки в конце цикла - LCD панель управления с 20 сохраняемыми программами - функция очистки масла в насосе и функция мягкого воздуха входит в стандартный комплект поставки. - система поршневого уплотнения со съёмной уплотнительной планкой без кабеля - возможность впрыска инертного газа - насос BUSH (немецкого производства) - функция "ступенчатого отпуска" и "дополнительной вакцины" включены. **Модели на колесах.**

	CAM500TC	CAM700TC	CAM900TC
	1,1 kW (1,5 HP)	1,5 kW (2 HP)	2 kW (2 HP)
	-	230-400V/3N/50-60Hz	
	230V/1N/50-60Hz	-	
	500 mm	2 x 700 mm	1 x 500mm 1 x 900mm
	20 m³/h	40 m³/h	63 m³/h
	98%		
	520 x 520 x 220(h) mm	720 x 570 x 220(h) mm	920 x 570 x 220(h) mm
	610 x 630 x 1050(h) mm	840 x 680 x 1050(h) mm	1040 x 680 x 1050(h) mm
			
	92 Kg	145 Kg	180 Kg
	107 Kg	160 Kg	205 Kg
	750 x 650 x 1150(h) mm	800 x 870 x 1150(h) mm	1100 x 800 x 1150(h) mm
	0,561 m³	0,800 m³	1,012 m³

\* Utilizzare solo buste per sottovuoto lisce.

Use only smooth vacuum bags.

N'utilisez que des sachets sous vide lisses.

Nur glatte Vakuum-Beutel benutzen.

Use sólo bolsas de vacío lisas.

Использовать только гладкие пакеты для вакуума.

# CAM300E CAM350E



CAM350E



CAM300E

## Macchine sottovuoto a campana - serie eco

CHAMBER VACUUM PACKERS  
MACHINES SOUS VIDE À CLOCHE  
KAMMER-VAKUUMVERPACKER  
ENVASADORAS AL VACÍO  
КОЛПАКОВЫЕ ВАКУУМНЫЕ  
УПАКОВОЧНЫЕ МАШИНЫ



IT Macchina per prolungare i tempi di conservazione degli alimenti mantenendone intatte le caratteristiche organolettiche e impedendone la proliferazione batterica a basse temperature. Carcassa e vasca interna in acciaio inox AISI 304 - vasca con angoli arrotondati - coperchio in plexiglass - apertura automatica del coperchio a fine ciclo - pannello comandi mono programma con possibilità di regolazione del vuoto e della saldatura - barra saldante a membrana - pompa a bagno d'olio DVP.











EN Machine aimed at prolonging food preservation times, keeping intact the organoleptic characteristics and preventing the proliferation of bacteria at low temperatures. Stainless steel AISI 304 casing and internal bowl - bowl with rounded corners - plexiglass lid - automatic lid opening at the end of the cycle - single program control panel with vacuum and sealing adjustment - membrane sealing bar - DVP oil bath pump.

FR Machine pour prolonger les temps de conservation des aliments, maintenir intactes les caractéristiques organoleptiques et empêcher la prolifération des bactéries à basse température. Corps et cuve intérieure en acier Inox AISI 304 - cuve avec coins arrondis - couvercle en plexiglas - ouverture automatique du couvercle en fin de cycle - panneau de commande à programme unique avec possibilité de réglage du vide et de la soudure - barre de soudure à membrane - pompe à bain d'huile DVP.

DE Maschine zur Verlängerung der Haltbarkeit von Lebensmitteln, die die organoleptischen Eigenschaften intakt hält und die Vermehrung von Bakterien bei niedrigen Temperaturen verhindert. Gehäuse und Innenschüssel aus Edelstahl AISI 304 - Schüssel mit abgerundeten Ecken - Plexiglasdeckel - automatische Deckelöffnung am Zyklusende - Einzelprogramm-Bedienfeld mit Vakuum- und Schweißanpassungsmöglichkeit - Membranschweißleiste - Ölbadpumpe DVP.

ES Máquina para prolongar el tiempo de conservación de los alimentos manteniendo intactas sus características organolépticas y evitando la proliferación bacteriana a bajas temperaturas. Carcasa y bol interior de acero inoxidable AISI 304 - bol interior con esquinas redondeadas - tapa en plexiglás - apertura automática de la tapa al final del ciclo - panel de control monoprograma con posibilidad de regular el vacío y la soldadura - barra de sellado de membrana - bomba de baño de aceite DVP.

RU Машина предназначена для продления сроков хранения продуктов питания, сохранения органолептических свойств и предотвращения размножения бактерий при низких температурах. Корпус из нержавеющей стали AISI 304 и внутренняя чаша - чаша с закругленными углами - крышка из оргстекла - автоматическое открытие крышки в конце цикла - однопрограммная панель управления с возможностью регулировки вакуума и сварки - Мембранная штанга - Насос с масляной ванной DVP.

	CAM300E	CAM350E
	0,75 kW (1 HP)	0,85 kW (1,2 HP)
	230V/1N/50-60Hz	
BARRA SALDANTE/ HOT-WELD SEALER	300 mm	350 mm
POMPA VUOTO/ VACUUM PUMP	8 m <sup>3</sup> /h	12 m <sup>3</sup> /h
VUOTO MAX OTTENIBILE/ MAX ACHIEVABLE VACUUM	98%	
	310 x 350 x 190(h) mm	360 x 400 x 190(h) mm
	410 x 460 x 430(h) mm	460 x 500 x 430(h) mm
		
	38 Kg	42 Kg
	44 Kg	48 Kg
	470 x 550 x 680(h) mm	600 x 650 x 680(h) mm
	0,176 m <sup>3</sup>	0,265 m <sup>3</sup>

\* Utilizzare solo buste per sottovuoto lisce.  
Use only smooth vacuum bags.  
N'utilisez que des sachets sous vide lisses.  
Nur glatte Vakuum-Beutel benutzen.  
Use sólo bolsas de vacío lisas.  
Использовать только гладкие пакеты для вакуума.

# CAM400E CAM450E



CAM400E

## Macchine sottovuoto a campana - serie eco

CHAMBER VACUUM PACKERS  
MACHINES SOUS VIDE À CLOCHE  
KAMMER-VAKUUMVERPACKER  
ENVASADORAS AL VACÍO  
КОЛПАКОВЫЕ ВАКУУМНЫЕ  
УПАКОВОЧНЫЕ МАШИНЫ

IT Macchina per prolungare i tempi di conservazione degli alimenti mantenendone intatte le caratteristiche organolettiche e impedendone la proliferazione batterica a basse temperature. Carcassa e vasca interna in acciaio inox AISI 304 - vasca con angoli arrotondati - coperchio in plexiglass - apertura automatica del coperchio a fine ciclo - pannello comandi mono programma con possibilità di regolazione del vuoto e della saldatura - barra saldante a membrana - pompa a bagno d'olio DVP.

EN Machine aimed at prolonging food preservation times, keeping intact the organoleptic characteristics and preventing the proliferation of bacteria at low temperatures. Stainless steel AISI 304 casing and internal bowl - bowl with rounded corners - plexiglass lid - automatic lid opening at the end of the cycle - single program control panel with vacuum and sealing adjustment - membrane sealing bar - DVP oil bath pump.

FR Machine pour prolonger les temps de conservation des aliments, maintenir intactes les caractéristiques organoleptiques et empêcher la prolifération des bactéries à basse température. Corps et cuve intérieure en acier Inox AISI 304 - cuve avec coins arrondis - couvercle en plexiglas - ouverture automatique du couvercle en fin de cycle - panneau de commande à programme unique avec possibilité de réglage du vide et de la soudure - barre de soudure à membrane - pompe à bain d'huile DVP.

DE Maschine zur Verlängerung der Haltbarkeit von Lebensmitteln, die die organoleptischen Eigenschaften intakt hält und die Vermehrung von Bakterien bei niedrigen Temperaturen verhindert. Gehäuse und Innenschüssel aus Edelstahl AISI 304 - Schüssel mit abgerundeten Ecken - Plexiglasdeckel - automatische Deckelöffnung am Zyklusende - Einzelprogramm-Bedienfeld mit Vakuum- und Schweißanpassungsmöglichkeit - Membranschweißleiste - Ölbadpumpe DVP

ES Máquina para prolongar el tiempo de conservación de los alimentos manteniendo intactas sus características organolépticas y evitando la proliferación bacteriana a bajas temperaturas. Carcasa y bol interior de acero inoxidable AISI 304 - bol interior con esquinas redondeadas - tapa en plexiglás - apertura automática de la tapa al final del ciclo - panel de control monoprograma con posibilidad de regular el vacío y la soldadura - barra de sellado de membrana - bomba de baño de aceite DVP.

RU Машина предназначена для продления сроков хранения продуктов питания, сохранения органолептических свойств и предотвращения размножения бактерий при низких температурах. Корпус из нержавеющей стали AISI 304 и внутренняя чаша - чаша с закругленными углами - крышка из оргстекла - автоматическое открытие крышки в конце цикла - однопрограммная панель управления с возможностью регулировки вакуума и сварки - Мембранная штанга - Насос с масляной ванной DVP.

	CAM400E	CAM450E
	1,1 kW (1,5 HP)	
	230V/1N/50-60Hz	
BARRA SALDANTE/ HOT-WELD SEALER	400 mm	450 mm
POMPA VUOTO/ VACUUM PUMP	20 m <sup>3</sup> /h	
VUOTO MAX OTTENIBILE/ MAX ACHIEVABLE VACUUM	98%	
	410 x 450 x 220(h) mm	460 x 500 x 220(h) mm
	510 x 560 x 450(h) mm	560 x 610 x 460(h) mm
		
	60 Kg	65 Kg
	67 Kg	72 Kg
	600 x 650 x 680(h) mm	700 x 700 x 720(h) mm
	0,265 m <sup>3</sup>	0,353 m <sup>3</sup>

\* Utilizzare solo buste per sottovuoto lisce.  
Use only smooth vacuum bags.  
N'utilisez que des sachets sous vide lisses.  
Nur glatte Vakuum-Beutel benutzen.  
Use sólo bolsas de vacío lisas.  
Использовать только гладкие пакеты для вакуума.

# MSD300P



## Macchine sottovuoto a barra saldante

BAR VACUUM PACKERS  
MACHINES SOUS VIDE À BARRE  
VAKUUMVERPACKER MIT SCHWEISSLEISTE  
ENVASADORAS AL VACÍO CON BARRA  
ВАКУУМНЫЕ УПАКОВОЧНЫЕ МАШИНЫ СО  
СВАРОЧНОЙ ПЛАНКОЙ

IT Macchina per prolungare i tempi di conservazione degli alimenti mantenendone intatte le caratteristiche organolettiche. Tramite l'utilizzo di apposite buste goffrate o contenitori si crea un livello di vuoto tale da impedire la proliferazione batterica a bassa temperatura. Carcassa in plastica - elettrovalvola apertura rapida barra - pompa a secco - automatica - digitale - provvista di sensore di regolazione altimetrica. Tutte le macchine sottovuoto supportano il vuoto in sacchetti o contenitori completi di coperchi specifici per l'utilizzo.







EN Machine aimed at prolonging food preservation times, keeping intact the organoleptic characteristics. The use of specific embossed bags or containers creates a vacuum level that keeps intact the organoleptic characteristics and prevents the proliferation of bacteria at low temperatures. Plastic casing - solenoid valve quick bar opening - dry pump - automatic - digital - equipped with height adjustment sensor. All vacuum machines can be used for vacuum in bags or containers with lids specifically designed for this purpose.

FR Machine pour prolonger les temps de conservation des aliments et maintenir intactes les caractéristiques organoleptiques. Grâce à l'usage de spéciales sachets ou conteneurs, il est possible créer un niveau de vide, tel de empêcher la prolifération bactérien à basse température. Corps en plastic - électrovanne d'ouverture rapide de la barre - pompe à sec - automatiques - numériques - munis de capteur de réglage altimétrique. Toutes les machines soutiennent le vide en sachets ou bien en conteneurs complets de couvercles spécifiques ce type d'usage.

DE Maschine zur Verlängerung der Haltbarkeit von Lebensmitteln, die die organoleptischen Eigenschaften intakt hält. Die Verwendung von speziellen geprägten Beuteln oder Behältern erzeugt ein Vakuumniveau, das die Vermehrung von Bakterien bei niedrigen Temperaturen verhindert. Kunststoffgehäuse - Magnetventil mit Schnellverschluss - Trockenpumpe - automatisch - digital - ausgestattet mit Höheneinstellsensor. Alle Vakuummaschinen können für das Vakuum in Beuteln oder Behältern mit speziellen Deckeln eingesetzt werden.

ES Máquina para prolongar el tiempo de conservación de los alimentos manteniendo sus características organolépticas. A través del uso de bolsas o contenedores especiales se produce un nivel de vacío que impide la proliferación bacteriana a baja temperatura. Carcasa de plástico - electroválvula abertura rápida de la barra - bomba a seco - automática - digital - dotado de sensor de regulación altimétrica. Todas las envasadoras al vacío pueden hacer vacío en bolsas o contenedores con tapas específicas para el uso.

RU Машина предназначена для продления сроков хранения продуктов питания, сохранения органолептических свойств. Использование специальных тисненных пакетов или контейнеров создает уровень вакуума, который сохраняет органолептические свойства и предотвращает размножение бактерий при низких температурах. Пластиковый корпус - электромагнитный клапан быстрого открытия барной стойки - сухой насос - автоматический - цифровой - оснащен датчиком регулировки высоты. Все вакуумные машины могут быть использованы для вакуума в мешках или контейнерах с соответствующими крышками.

	<b>MSD300P</b>
	0,49 kW (0,7 HP)
 1 Ph	230V/1N/50-60Hz
BARRA SALDANTE/ HOT-WELD SEALER	320 mm
POMPA VUOTO/ VACUUM PUMP	0,9 m <sup>3</sup> /h
VUOTO MAX OTTENIBILE/ MAX.ACHIEVABLE VACUUM	80%
	390 x 310 x 140(h) mm
	
 NET Kg	4,5 Kg
 GROSS Kg	5,5 Kg
 mm	420 x 350 x 190(h) mm
 m <sup>3</sup>	0,028 m <sup>3</sup>

\* Utilizzare solo buste per sottovuoto goffrate.  
Use only embossed bags.  
Utiliser seulement les sachets gaufrés.  
Nur gaufrierte Beutel fuer vakuum benutzen.  
Usar solo bolsas para envasado al vacío gofradas.  
Использовать только пакеты для вакуума с тиснением.

# BAR300P BAR350



BAR300P



BAR350

Macchine sottovuoto  
a barra saldante

BAR VACUUM PACKERS  
MACHINES SOUS VIDE À BARRE  
VAKUUMVERPACKER MIT SCHWEISSLEISTE  
ENVASADORAS AL VACÍO CON BARRA  
ВАКУУМНЫЕ УПАКОВОЧНЫЕ МАШИНЫ СО  
СВАРОЧНОЙ ПЛАНКОЙ



IT Macchina per prolungare i tempi di conservazione degli alimenti mantenendone intatte le caratteristiche organolettiche. Tramite l'utilizzo di apposite buste goffrate o contenitori si crea un livello di vuoto tale da impedire la proliferazione batterica a bassa temperatura. **BAR300P:** Robusta carcassa in ABS e acciaio inox - pompa a secco - pannello comandi digitale.

**BAR350:** Carcassa in acciaio inox - pompa a secco - pannello comandi digitale per saldatura manuale oppure tramite due programmi di lavoro pre-impostati. Tutte le macchine sottovuoto supportano il vuoto in sacchetti o contenitori completi di coperchi specifici per l'utilizzo.

EN Machine aimed at prolonging food preservation times, keeping intact the organoleptic characteristics. The use of specific embossed bags or containers creates a vacuum level that keeps intact the organoleptic characteristics and prevents the proliferation of bacteria at low temperatures. **BAR300P:** Robust ABS and stainless steel casing - dry pump - digital control panel.

**BAR350:** Stainless steel casing - dry pump - digital control panel for manual sealing or by using two pre-set programs. All vacuum machines can be used for vacuum in bags or containers with lids specifically designed for this purpose.

FR Machine pour prolonger les temps de conservation des aliments et maintenir intactes les caractéristiques organoleptiques. Grâce à l'usage de spéciales sachets ou conteneurs, il est possible créer un niveau de vide, tel de empêcher la prolifération bactérien à baisse température. **BAR300P:** corps robuste en ABS et acier inox - pompe à sec - panneau des commandes digital.

**BAR350:** corps en acier inox - pompe à sec - panneau des commandes digital pour soudure manuelle, ou bien à travers deux programmes de travail pré-réglés. Toutes les machines soutiennent le vide en sachets ou bien en conteneurs complets de couvercles spécifiques ce type d'usage.

DE Maschine zur Verlängerung der Haltbarkeit von Lebensmitteln, die die organoleptischen Eigenschaften intakt hält. Die Verwendung von speziellen geprägten Beuteln oder Behältern erzeugt ein Vakuumniveau, das die Vermehrung von Bakterien bei niedrigen Temperaturen verhindert.

**BAR300P:** Robustes ABS- und Edelstahlgehäuse - Trockene Pumpe - Digitales Bedienfeld **BAR350:** Edelstahlgehäuse - Trockene Pumpe - Digitales Bedienfeld für manuelle Versiegelung oder mit zwei voreingestellten Programmen. Alle Vakuummaschinen können für das Vakuum in Beuteln oder Behältern mit speziellen Deckeln eingesetzt werden.

ES Máquina para prolongar el tiempo de conservación de los alimentos manteniendo sus características organolépticas. A través del uso de bolsas o contenedores especiales se produce un nivel de vacío que impide la proliferación bacteriana a baja temperatura. **BAR300P:** Carcasa fuerte en ABS y acero inoxidable - bomba en seco - panel de control digital.

**BAR350:** Carcasa de acero inoxidable - bomba en seco - panel de control digital para la soldadura manual o por medio de dos programas de trabajo preestablecidos. Todas las envasadoras al vacío pueden hacer vacío en bolsas o contenedores con tapas específicas para el uso.

RU Машина предназначена для продления сроков хранения продуктов питания, сохранения органолептических свойств. Использование специальных тисненных пакетов или контейнеров создает уровень вакуума, который сохраняет органолептические свойства и предотвращает размножение бактерий при низких температурах.

**BAR300P:** Прочный корпус из ABS и нержавеющей стали - сухой насос - цифровая панель управления. **BAR350:** Корпус из нержавеющей стали - сухой насос - цифровая панель управления для ручного уплотнения или с помощью двух предустановленных программ. Все вакуумные машины могут быть использованы для вакуума в мешках или контейнерах с соответствующими крышками.

	BAR300P	BAR350
	0,45 kW (0,6 HP)	
 1 Ph	230V/1N/50Hz	
BARRA SALDANTE/ HOT-WELD SEALER	300 mm	350 mm
POMPA VUOTO/ VACUUM PUMP	1,2 m <sup>3</sup> /h	
VUOTO MAX OTTENIBILE/ MAX.ACHIEVABLE VACUUM	85%	
	320 x 260 x 140(h) mm	370 x 280 x 170(h) mm
		
 NET Kg	6 Kg	8 Kg
 GROSS Kg	7 Kg	9 Kg
 mm	420 x 290 x 210(h) mm	510 x 330 x 245(h) mm
 m <sup>3</sup>	0,025 m <sup>3</sup>	0,040 m <sup>3</sup>

\* Utilizzare solo buste per sottovuoto goffrate.

Use only embossed bags.

Utiliser seulement les sachets gaufrés.

Nur gaufrierte Beutel fuer vakuum benutzen.

Usar solo bolsas para envasado al vacío gofradas.

Использовать только пакеты для вакуума с тиснением.

# BAR400 BAR500



BAR400



BAR500

## Macchine sottovuoto a barra saldante

BAR VACUUM PACKERS  
MACHINES SOUS VIDE À BARRE  
VAKUUMVERPACKER MIT SCHWEISSLEISTE  
ENVASADORAS AL VACÍO CON BARRA  
ВАКУУМНЫЕ УПАКОВОЧНЫЕ МАШИНЫ СО  
СВАРОЧНОЙ ПЛАНКОЙ



IT Macchina per prolungare i tempi di conservazione degli alimenti mantenendone intatte le caratteristiche organolettiche. Tramite l'utilizzo di apposite buste goffrate o contenitori si crea un livello di vuoto tale da impedire la proliferazione batterica a bassa temperatura. Carcasa in acciaio inox AISI 304 - **pompa a secco per il modello BAR400, pompa a bagno d'olio per il modello BAR500** - pannello comandi digitale per programmare tempo di saldatura e di vuoto - start automatico nell'abbassamento della barra superiore - apertura automatica della barra a fine ciclo. Tutte le macchine sottovuoto supportano il vuoto in sacchetti o contenitori completi di coperchi specifici per l'utilizzo.







EN Machine aimed at prolonging food preservation times, keeping intact the organoleptic characteristics. The use of specific embossed bags or containers creates a vacuum level that keeps intact the organoleptic characteristics and prevents the proliferation of bacteria at low temperatures. Stainless steel AISI 304 casing - **dry pump for BAR400 model, oil bath pump for BAR500 model** - digital control panel to set sealing and vacuum time - automatic start when lowering the upper bar - automatic bar opening at the end of the cycle. All vacuum machines can be used for vacuum in bags or containers with lids specifically designed for this purpose.

FR Machine pour prolonger les temps de conservation des aliments et maintenir intactes les caractéristiques organoleptiques. Grâce à l'usage de spéciales sachets ou conteneurs, il est possible créer un niveau de vide, tel de empêcher la prolifération bactérien à baisse température. Corps en acier Inox AISI 304 - **pompe sèche pour le modèle BAR400, pompe à bain d'huile pour le modèle BAR500** - panneau de commande numérique pour programmer le temps de soudage et de vide - démarrage automatique lors de la descente de la barre supérieure - ouverture automatique de la barre à la fin du cycle. Toutes les machines soutiennent le vide en sachets ou bien en conteneurs complets de couvercles spécifiques ce type d'usage.

DE Maschine zur Verlängerung der Haltbarkeit von Lebensmitteln, die die organoleptischen Eigenschaften intakt hält. Die Verwendung von speziellen geprägten Beuteln oder Behältern erzeugt ein Vakuumniveau, das die Vermehrung von Bakterien bei niedrigen Temperaturen verhindert. Gehäuse aus Edelstahl AISI 304 - **Trockenpumpe für das Modell BAR400, Ölbadpumpe für das Modell BAR500** - digitales Bedienfeld zur Programmierung von Schweiß- und Vakuumzeit - automatischer Start beim Absenken des oberen Stabes - automatische Öffnung des Stabes am Ende des Zyklus. Alle Vakuummaschinen können für das Vakuum in Beuteln oder Behältern mit speziellen Deckeln eingesetzt werden.

ES Máquina para prolongar el tiempo de conservación de los alimentos manteniendo sus características organolépticas. A través del uso de bolsas o contenedores especiales se produce un nivel de vacío que impide la proliferación bacteriana a baja temperatura. Carcasa de acero inoxidable AISI 304 - **bomba a seco en el modelo BAR400, de baño de aceite en el modelo BAR500** - panel de control digital para regular el tiempo de soldadura y de vacío - start automático al bajar la barra superior - apertura automática de la barra al final del ciclo. Todas las envasadoras al vacío pueden hacer vacío en bolsas o contenedores con tapas específicas para el uso.

RU Машина предназначена для продления сроков хранения продуктов питания, сохранения органолептических свойств. Использование специальных тисненных пакетов или контейнеров создает уровень вакуума, который сохраняет органолептические свойства и предотвращает размножение бактерий при низких температурах. Корпус из нержавеющей стали AISI 304 - **сухой насос для модели BAR400, масляный насос для модели BAR500** - цифровая панель управления для программирования времени сварки и вакуума - автоматический запуск при опускании верхней штанги - автоматическое открытие штанги в конце цикла. Все вакуумные машины могут быть использованы для вакуума в мешках или контейнерах с соответствующими крышками.

	BAR400	BAR500
	0,55 kW (0,7 HP)	0,75 kW (1 HP)
 1 Ph	230V/1N/50Hz	230V/1N/50-60Hz
BARRA SALDANTE/ HOT-WELD SEALER	400 mm	500 mm
POMPA VUOTO/ VACUUM PUMP	2,4 m <sup>3</sup> /h	4 m <sup>3</sup> /h
VUOTO MAX OTTENIBILE/ MAX ACHIEVABLE VACUUM	85%	98%
 mm	420 x 280 x 180(h) mm	520 x 380 x 210(h) mm
		
 Kg	13 Kg	23 Kg
 Kg	14 Kg	24 Kg
 mm	550 x 365 x 250(h) mm	610 x 420 x 300(h) mm
 m <sup>3</sup>	0,050 m <sup>3</sup>	0,076 m <sup>3</sup>

\* Utilizzare solo buste per sottovuoto goffrate.  
Use only embossed bags.  
Utiliser seulement les sachets gauffrés.  
Nur gaufrierte Beutel fuer vakuum benutzen.  
Usar solo bolsas para envasado al vacío gofradas.  
Использовать только пакеты для вакуума с тиснением.



CAM700TC



CAM500T



MSD300P



BAR300P



CAM300E



BAR350



BAR500



BAR400

Optional  
macchine per sottovuoto

ACCESSORIES  
ACCESSOIRES  
ZUBEHÖR  
ACCESORIOS  
AKCECCYAPЫ

Mod.	Temp. max / h	 mm	Confezione 100 pz Pack 100 pcs 100 pièces par paquet 100 Stk. Packung 100 uds. por caja 100 шт. в упаковке
<b>µm 90</b> Buste Goffrate - Conservazione e cottura Embossed bags - Preservation and cooking Sacs gaufrés - Conservation et cuisson Geprägte Beutel - Konservieren und kochen Bolsas gofrados - Conservación y cocina Конверты с тиснением – хранение и приготовление	100°C - 2 h	150 x 300 mm	SAC03
		200 x 300 mm	SAC01
		250 x 350 mm	SAC05
		300 x 400 mm	SAC02
<b>µm 90</b> Buste Goffrate per cottura extra performance Embossed bags for extra performance cooking Sacs gaufrés pour une cuisson encore plus performante Geprägte Beutel für besonders leistungsstarkes Kochen Bolsas gofradas para una cocción de mayor rendimiento Рельефные пакеты для более эффективного приготовления	120°C - 4 h	200 x 300 mm	SAC01C
		300 x 400 mm	SAC02C
<b>µm 90</b> Buste lisce - Conservazione e cottura Smooth bags - Preservation and cooking Sacs lisses - Conservation et cuisson Glatte Beutel - Konservieren und kochen Bolsas lisas - Conservación y cocina Гладкие пакеты – Хранение и приготовление пищи	100°C - 2 h	200 x 300 mm	SAC11
		250 x 350 mm	SAC12
		300 x 400 mm	SAC14

Mod.	 mm	
2 rotoli - 2 rolls - 2 rouleaux 2 Rollen - 2 rollos - 2 рулонов	200 x 6000 mm	ROT01
	300 x 6000 mm	ROT02

ROT01

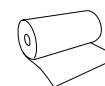

ROT02

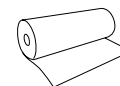

	<p>Stampante e tastiera Printer and keyboard Imprimante et clavier Drucker und Tastatur Impresora y teclado Печатающее устройство с кнопчным пультом</p>	<p>Rotolo di carta adesiva per stampante Adhesive printer paper roll Rouleau de papier adhésif pour imprimante Klebepapierrolle für Drucker Rollo de papel adhesivo para impresora Рулон клейкой бумаги для печатающего устройства</p>
Mod.	CAM TOP	

	<p>Barra saldante aggiuntiva Additional sealing bar Barre de soudure supplémentaire Zusätzliche Schweißstange Barra selladora añadida Дополнительная сварочная планка для моделей</p>	<p>Configurazione barre fuori standard Non-standard bar configuration Configuration des barres hors standards Nicht standardmäßige Stangenkonfiguration Configuración de las barras fuera estándar Конфигурация нестандартных планок</p>
Mod.	CAM500TC - CAM700TC - CAM900TC	

### CAM500TC

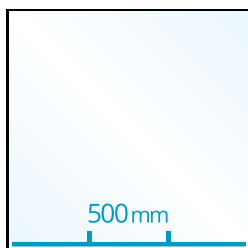

STANDARD

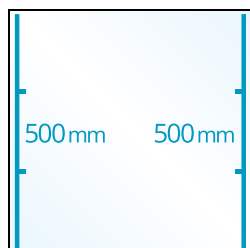

OPTIONAL

### CAM700TC

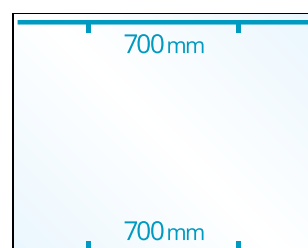

STANDARD



OPTIONAL



### CAM900TC

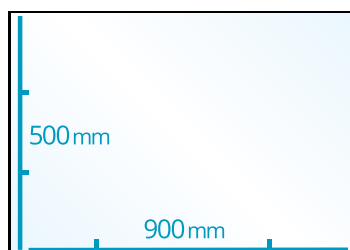

STANDARD

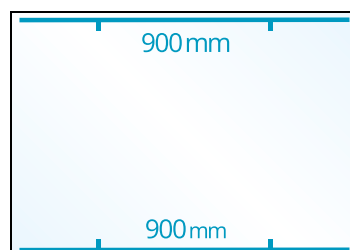

OPTIONAL

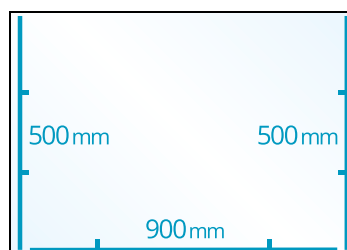



TS300  
TS400



TS300



TS400

# Termosigillatrici semi-automatiche

SEMI-AUTOMATIC  
THERMOSEALING MACHINE  
THERMOSCELLEUSE SEMI-AUTOMATIQUE  
HALBAUTOMATISCHE  
THERMOVERSIEGELUNGSMASCHINE  
TERMOSELLADORA SEMIAUTOMÁTICA  
ПОЛУАВТОМАТИЧЕСКАЯ  
ТЕРМОУПАКОВОЧНАЯ МАШИНА

IT Termosigillatrice semi-automatica per il confezionamento di prodotti in vaschetta. Possibilità di sigillare in maniera igienica i prodotti in vaschetta al fine di migliorarne la conservazione - ciclo di lavoro manuale - comandi digitali - **stampi non inclusi**.

EN Semi-automatic thermosealing machine for the packaging of products in trays. Allows to hygienically seal products in trays in order to improve their preservation - manual working cycle - digital controls - **moulds not included**.

FR Thermoscelleuse semi-automatique pour l'emballage de produits en bacs. Permet de sceller hygiéniquement les produits en bacs afin d'améliorer leur conservation - cycle de travail manuel - commandes numériques - **moules non inclus**.

DE Halbautomatische Thermoversiegelungsmaschine zum Verpacken von Produkten in Schalen. Kann Produkte in Schalen hygienisch versiegeln, um ihre Haltbarkeit zu verbessern - manueller Arbeitszyklus - digitale Steuerung - **Formen nicht inbegriffen**.

ES Termoselladora semiautomática para el envasado de productos en bandejas. Posibilidad de sellar higiénicamente los productos en bandejas para mejorar su conservación - ciclo de trabajo manual - controles digitales - **moldes no incluidos**.

RU Полуавтоматическая термоупаковочная машина для упаковки продуктов в лотки. Возможность гигиенической герметизации продуктов в лотках для улучшения их сохранности - ручной рабочий цикл - цифровое управление - **формы в комплект не входят**.

	TS300	TS400
	0,6 kW	1,2 kW
 1 Ph	230V/1N/50-60Hz	
	200 mm	370 mm
 mm	280 x 500 x 600(h) mm aperto / open	400 x 500 x 600(h) mm aperto / open
		
 NET Kg	16 Kg	26 Kg
 GROSS Kg	18 Kg	32 Kg
 mm	600 x 400 x 300(h) mm	610 x 520 x 490(h) mm
 m <sup>3</sup>	0,10 m <sup>3</sup>	0,29 m <sup>3</sup>

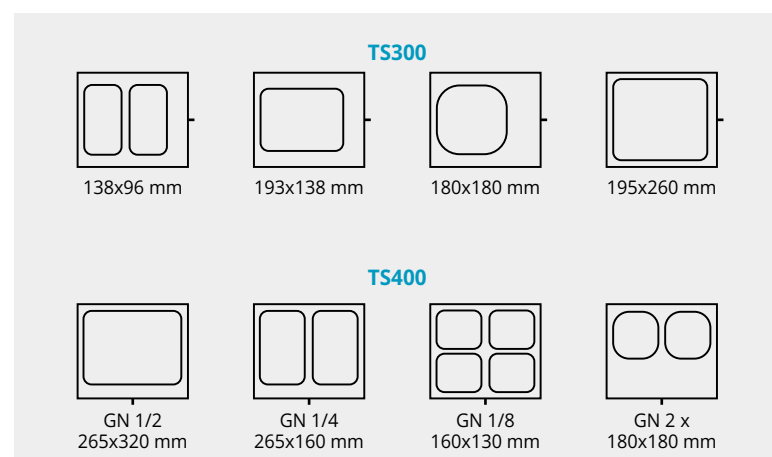

TS1A  
TS2A



TS1A

# Termosigillatrici automatiche

HEAT SEALERS  
THERMOSCELLEUSES  
THERMOVERSIEGELUNGSGERÄTE  
SELLADORAS TÉRMICAS  
ТЕРМОЗАПЕЧАТЫВАЮЩАЯ МАШИНА



IT Macchina per termo sigillare gli alimenti dentro le vaschette permettendo di mantenere fragranza e gusto. Costruite in acciaio inox AISI 304, con piastra saldante interna per evitare scottature, trascinamento automatico del film senza alcun ausilio manuale, controllo elettronico della temperatura di saldatura per sigillare perfettamente le vaschette - **sigillatura automatica** - fino a 9 programmi pre-impostati - dai 6 agli 8 cicli al minuto di lavoro - **dotate di stampo multiform**. Vaschette disponibili su richiesta.

EN Machine for thermo sealing of foods inside the containers allowing to maintain fragrance and taste. Made of stainless steel AISI 304, with internal sealing plate to avoid burns, automatic film dragging with no manual aid, electronic sealing temperature control to perfectly seal the containers - **automatic sealing** - up to 9 pre-set programs - from 6 to 8 operating cycles per minute. **Equipped with Multiform mould**. Containers available on request.

FR Machine de thermoscellage des aliments à l'intérieur des bacs permettant de maintenir la fragrance et le goût. En acier Inox AISI 304, avec plaque de scellage interne pour éviter les brûlures, entraînement automatique du film sans aide manuelle, contrôle électronique de la température de scellage pour sceller parfaitement les récipients - **scellage automatique** - jusqu'à 9 programmes prédéfinis - de 6 à 8 cycles par minute de travail - **équipée de moule Multiform**. Bacs disponibles sur demande.

DE Maschine zum thermischen Verschließen von Lebensmitteln in den Behältern, die es ermöglicht, Duft und Geschmack zu erhalten. Aus Edelstahl AISI 304, mit innenliegender Siegelplatte zur Vermeidung von Verbrennungen, automatisches Nachziehen der Folie ohne manuelle Hilfe, elektronischer Siegeltemperaturregler zum perfekten Verschließen der Behälter - **automatisches Verschließen** - bis zu 9 voreingestellte Programme - von 6 bis 8 Betriebszyklen pro Minute - **ausgestattet mit Multiform-Form**. Behältern auf Anfrage erhältlich.

ES Máquina para termosellar los alimentos en bandejas, para que mantengan su fragancia y sabor. Máquinas de acero inoxidable AISI 304, con placa de sellado interior para evitar quemaduras, arrastre automático del film sin ninguna ayuda manual, control electrónico de la temperatura de soldadura para sellar perfectamente las bandejas - **sellado automático**. Hasta 9 programas preestablecidos - de 6 a 8 ciclos de trabajo al minuto - **equipado con molde multiform**. Bandejas disponibles a petición.

RU Машина для термозапечатывания пищевых продуктов внутри емкостей, позволяющая поддерживать аромат и вкус. Изготовлен из нержавеющей стали AISI 304, с внутренней плитой для предотвращения ожогов, автоматическое перетаскивание пленки без помощи оператора, электронный контроль температуры пломбы для идеальной герметизации контейнеров - автоматическое пломбирование для модели TS1A/TS2A/TS3A - до 9 предустановленных программ - от 6 до 8 рабочих циклов в минуту - **оснащены пресс-формами Multiform**. Лотки доступны по запросу.

	TS1A	TS2A
	0,55 kW (0,7 HP)	0,75 kW (1 HP)
	230V/1N/50Hz	
	150 mm - ø 160 mm 150 mt	220 mm - ø 200 mm 150 mt
	240 x 300 x 500(h) mm	315 x 450 x 550(h) mm
		
	20 Kg	25 Kg
	23 Kg	28 Kg
	260 x 420 x 520(h) mm	320 x 460 x 570(h) mm
	0,057 m³	0,084 m³

## INCLUSO/INCLUDED

Combinazione vaschette - Container combination  
Комбинированные лотки

TS1A

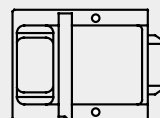

137x190 mm  
137x125 mm  
137x95 mm

TS2A

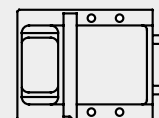

190x260 mm  
190x230 mm  
190x137 mm  
95x137 mm

OPTIONAL



# TS3A



## Termosigillatrice automatica

HEAT SEALERS  
THERMOSCELLEUSES  
THERMOVERSIEGELUNGSGERÄTE  
SELLADORAS TÉRMICAS  
ТЕРМОЗАПЕЧАТЫВАЮЩАЯ МАШИНА

IT Macchina per termo sigillare gli alimenti dentro le vaschette, permettendo così di mantenere fragranza e gusto. Costruita in acciaio inox AISI 304 - piastra saldante interna per evitare scottature - trascinamento automatico del film senza alcun ausilio manuale - controllo elettronico della temperatura di saldatura per sigillare perfettamente le vaschette - dai 6 agli 8 cicli al minuto di lavoro - **non è dotata di stampo di serie**, è possibile sceglierne uno tra gli optional. Vaschette disponibili su richiesta.

EN Machine for thermo sealing of foods inside the containers allowing to maintain fragrance and taste. Made of stainless steel AISI 304 - internal sealing plate to avoid burns - automatic film dragging with no manual aid - electronic sealing temperature control to perfectly seal the containers - from 6 to 8 operating cycles per minute. **Not equipped with moulds**, you can choose one among our options. Containers available on request.

FR Machine de thermoscellage des aliments à l'intérieur des bacs permettant de maintenir la fragrance et le goût. En acier Inox AISI 304 - plaque de scellage interne pour éviter les brûlures - entraînement automatique du film sans aide manuelle - contrôle électronique de la température de scellage pour sceller parfaitement les récipients - de 6 à 8 cycles par minute de travail - **pas de moule en standard**, vous pouvez en choisir un en option. Bacs disponibles sur demande.

DE Maschine zum thermischen Verschließen von Lebensmitteln in den Behältern, die es ermöglicht, Duft und Geschmack zu erhalten. Aus Edelstahl AISI 304 - mit innenliegender Siegelplatte zur Vermeidung von Verbrennungen - automatisches Nachziehen der Folie ohne manuelle Hilfe - elektronischer Siegeltemperaturregler zum perfekten Verschließen der Behälter - von 6 bis 8 Betriebszyklen pro Minute - **standardmäßig ohne Form**, optional kann eine Form gewählt werden. Behältern auf Anfrage erhältlich.

ES Máquina para termosellar los alimentos en bandejas, para que mantengan su fragancia y sabor. Máquinas de acero inoxidable AISI 304, con placa de sellado interior para evitar quemaduras, arrastre automático del film sin ninguna ayuda manual, control electrónico de la temperatura de soldadura para sellar perfectamente las bandejas - de 6 a 8 ciclos de trabajo al minuto - **no tiene bandejas de serie**, puede elegir una como opción. Bandejas disponibles bajo pedido.

RU Машина для термозапечатывания пищевых продуктов внутри емкостей, позволяющая поддерживать аромат и вкус. Изготовлен из нержавеющей стали AISI 304, с внутренней плитой для предотвращения ожогов, автоматическое перетаскивание пленки без помощи оператора, электронный контроль температуры пломбы для идеальной герметизации контейнеров - до 9 предустановленных программ - от 6 до 8 рабочих циклов в минуту - **не оснащены стандартной пресс-формой**, вы можете выбрать одну. Лотки доступны по запросу.

	<b>TS3A</b>
	1,5 kW (2 HP)
	230V/1N/50Hz
	380 mm - ø 200 mm - 150 mt
	460 x 510 x 555(h) mm
	
	35 Kg
	40 Kg
	470 x 510 x 570(h) mm
	0,137 m³

## NON INCLUSO / NOT INCLUDED

Combinazione vaschette - Container combination  
Комбинированные лотки

TS3A

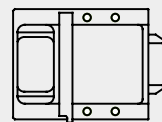

190x260 mm  
190x230 mm  
190x137 mm  
95x137 mm

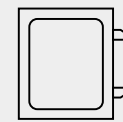

370x280 mm

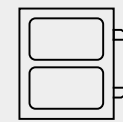

180x280 mm  
(2x)

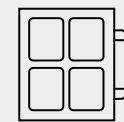

180x135 mm  
(4x)

OPTIONAL



TS1  
TS2



# Termosigillatrici manuali

HEAT SEALERS  
THERMOSCELLEUSES  
THERMOVERSIEGELUNGSGERÄTE  
SELLADORAS TÉRMICAS  
ТЕРМОЗАПЕЧАТЫВАЮЩАЯ МАШИНА

IT Macchina per termo sigillare gli alimenti dentro le vaschette permettendo di mantenere fragranza e gusto. Costruite in acciaio inox AISI 304, con piastra saldante interna per evitare scottature, trascinamento automatico del film senza alcun ausilio manuale, controllo elettronico della temperatura di saldatura per sigillare perfettamente le vaschette - **sigillatura manuale tramite pressione leva** - fino a 9 programmi pre-impostati - dai 6 agli 8 cicli al minuto di lavoro - **dotate di stampo multiform**. Vaschette disponibili su richiesta.

EN Machine for thermo sealing of foods inside the containers allowing to maintain fragrance and taste. Made of stainless steel AISI 304, with internal sealing plate to avoid burns, automatic film dragging with no manual aid, electronic sealing temperature control to perfectly seal the containers - **manual sealing by lever pressure** - up to 9 pre-set programs - from 6 to 8 operating cycles per minute. **Equipped with Multiform mould**. Containers available on request.

FR Machine de thermoscellage des aliments à l'intérieur des bacs permettant de maintenir la fragrance et le goût. En acier Inox AISI 304, avec plaque de scellage interne pour éviter les brûlures, entraînement automatique du film sans aide manuelle, contrôle électronique de la température de scellage pour sceller parfaitement les récipients - **scellage manuel par pression du levier** - jusqu'à 9 programmes prédéfinis - de 6 à 8 cycles par minute de travail - **équipée de moule Multiform**. Bacs disponibles sur demande.

DE Maschine zum thermischen Verschließen von Lebensmitteln in den Behältern, die es ermöglicht, Duft und Geschmack zu erhalten. Aus Edelstahl AISI 304, mit innenliegender Siegelplatte zur Vermeidung von Verbrennungen, automatisches Nachziehen der Folie ohne manuelle Hilfe, elektronischer Siegeltemperaturregler zum perfekten Verschließen der Behälter - **manuelles Verschließen** - bis zu 9 voreingestellte Programme - von 6 bis 8 Betriebszyklen pro Minute - **ausgestattet mit Multiform-Form**. Behältern auf Anfrage erhältlich.

ES Máquina para termosellar los alimentos en bandejas, para que mantengan su fragancia y sabor. Máquinas de acero inoxidable AISI 304, con placa de sellado interior para evitar quemaduras, arrastre automático del film sin ninguna ayuda manual, control electrónico de la temperatura de soldadura para sellar perfectamente las bandejas - **el sellado es manual**. Hasta 9 programas preestablecidos - de 6 a 8 ciclos de trabajo al minuto - **equipado con molde multiform**. Bandejas disponibles a petición.

RU Машина для термозапечатывания пищевых продуктов внутри емкостей, позволяющая поддерживать аромат и вкус. Изготовлен из нержавеющей стали AISI 304, с внутренней плитой для предотвращения ожогов, автоматическое перетаскивание пленки без помощи оператора, электронный контроль температуры пломбы для идеальной герметизации контейнеров - **ручное пломбирование с помощью рычага давления** - до 9 предустановленных программ - от 6 до 8 рабочих циклов в минуту - оснащены **пресс-формами Multiform**. Лотки доступны по запросу.

	TS1	TS2
	0,5 kW (0,6 HP)	0,7 kW (1 HP)
	230V/1N/50Hz	
	150 mm - ø 160 mm - 150 mt	220 mm - ø 200 mm - 150 mt
	260 x 300 x 500(h) mm	315 x 450 x 550(h) mm
		
	20 Kg	25 Kg
	23 Kg	28 Kg
	260 x 420 x 520(h) mm	320 x 460 x 570(h) mm
	0,057 m³	0,084 m³

## INCLUSO/INCLUDED

Combinazione vaschette - Container combination  
Комбинированные лотки

TS1

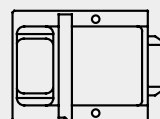

137x190 mm  
137x125 mm  
137x95 mm

TS2

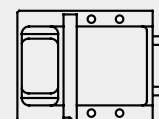

190x260 mm  
190x230 mm  
190x137 mm  
95x137 mm

OPTIONAL





TS300



TS400



TS3A

Optional  
termosigillatrici

ACCESSORIES  
ACCESSOIRES  
ZUBEHÖR  
ACCESORIOS  
AKCECCYAPЫ

Vaschette personalizzabili - specificare misura al momento dell'ordine Customisable containers - specify size when ordering Bacs personnalisables - spécifier la taille lors de la commande Maßgeschneiderte Behälter - Größe bei der Bestellung angeben Bandejas personalizables: especifique el tamaño al realizar el pedido Лотки могут быть изготовлены по индивидуальному заказу - укажите размер при заказе			
	Mod.		Impronte - Impression - Empreinte Vertiefung - Sellado - Оттиск
ACSTTSA01	TS3A	Dim. Max. 370 x 280 mm	n. 1
ACSTTSA02		Dim. Max. 180 x 280 mm	n. 2
ACSTTSA03		Dim. Max. 180 x 135 mm	n. 4
ACSTTSA06		190 x 260 mm - 190 x 230 mm 190 x 137 mm - 95 x 137 mm	multiform

Stampi - Moulds - Moules - Formen - Moldes - Штампы			
	Mod.		Impronte - Impression - Empreinte Vertiefung - Sellado - Оттиск
ACSTTSA04	TS1-TS1A	137 x 190 mm - 137 x 125 mm - 137 x 95 mm	multiform
ACSTTSA07	TS2-T2SA	190 x 260 mm - 190 x 230 mm 190 x 137 mm - 95 x 137 mm	multiform
ACSTTS3001	TS300	138 x 96 mm	n. 2
ACSTTS3002		193 x 138 mm	n. 1
ACSTTS3003		180 x 180 mm	n. 1
ACSTTS3004		195 x 260 mm	n. 1
ACSTTS4001	TS400	265 x 320 mm - GN1/2	n. 1
ACSTTS4002		265 x 160 mm - GN1/4	n. 2
ACSTTS4003		160 x 130 mm - GN1/8	n. 4
ACSTTS4004		180 x 180 mm - GN2	n. 2

A richiesta vaschette di diverse dimensioni - On request different container combination

Bobine film / Film reels / Bobines de film Folienrolle / Bobina de película / бобины с пленкой		
Mod.		Mod.
BOB01	150 mm - 150 m	TS1 - TS1A - TS300
BOB02	200 mm - 150 m	TS2 - TS2A - TS300
BOB05	370 mm - 150 m	TS400

**BOB-01**  
TS1 / TS1A /  
TS300



150 mm  
ø 160 mm  
150 m

**BOB-02**  
TS2 / TS2A /  
TS300

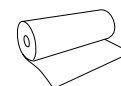

200 mm  
ø 200 mm  
150 m

**BOB-05**  
TS400

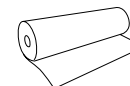

370 mm  
ø 200 mm  
150 m

# ALP3000



Asciuga lucida posate

CUTLERY DRYER-POLISHER  
MACHINES À ESSUYER  
ET POLIR LES COUVERTS  
BESTECKTROCKNER-/POLIERER  
SECADORAS ABRILLANTADORAS DE CUBIERTOS  
СУШИЛЬНО-ПОЛИРОВОЧНАЯ МАШИНА ДЛЯ  
СТОЛОВЫХ ПРИБОРОВ



IT Macchina per asciugare e lucidare le posate appena uscite dalla lavastoviglie rendendole asciutte e brillanti senza macchie di calcare grazie alla sinergia della vibrazione della vasca interna e allo sfregamento della polvere di tutolo di mais (prodotto completamente vegetale, atossico, trattato con particolari agenti antibatterici). Realizzata in acciaio inox AISI 304 - dotata di una lampada UV che diminuisce la carica batterica presente nelle posate anche dopo il lavaggio - vasca interna rivestita con resina resistente agli urti e certificata ad uso alimentare - capacità di 50 posate al minuto.

EN Cutlery dryer-polisher is created to quickly dry and polish wet cutlery straight out of the dishwasher. Thanks to the synergy of the internal bowl vibrations and to the friction of the corncob powder (completely vegetable product, non-toxic, treated with special antibacterial agents), the cutlery comes out perfectly dry and shiny, with no limescale spots, thus avoiding lengthy polishing by hand. Made of stainless steel AISI 304 - equipped with a UV lamp that reduces the bacterial load in the cutlery even after washing - internal bowl coated with impact-resistant resin certified for food use - capacity of 50 pieces per minute.

FR La machine à essuyer et polir les couverts est conçu pour sécher et polir rapidement les couverts mouillés qui sortent directement du lave-vaisselle. Grâce à la synergie des vibrations internes de la cuve et au frottement de la poudre de rafles de maïs (produit entièrement végétal, non toxique, traité avec des agents antibactériens spéciaux), les couverts ressortent parfaitement secs et brillants, sans trace de calcaire, ce qui évite un long polissage à la main. Fabriqué en acier Inox AISI 304 - équipé d'une lampe UV qui réduit la charge bactérienne dans la coutellerie même après le lavage - cuve interne recouverte d'une résine résistante aux chocs et certifiée pour un usage alimentaire - capacité de 50 pièces par minute.

DE Der Besteckrockner-Polierer dient zum schnellen Trocknen und Polieren von nassem Besteck direkt aus der Geschirrspülmaschine. Dank der Synergie der inneren Schüsselschwingungen und der Reibung des Maiskolbenpulvers (rein pflanzliches Produkt, ungiftig, mit speziellen antibakteriellen Mitteln behandelt) entsteht ein perfekt trockenes und glänzendes Besteck ohne Kalkflecken, wodurch langes Polieren von Hand vermieden wird. Aus Edelstahl AISI 304 - ausgestattet mit einer UV-Lampe, die die Bakterienbelastung im Besteck auch nach dem Waschen reduziert - Innenschüssel mit schlagfestem, lebensmitteltauglichem Harz beschichtet - Leistung 50 Stück pro Minute.

ES Máquina realizada para secar y abrillantar rápidamente cubiertos mojados, recién salidos de la lavavajillas. Gracias a la sinergia de la vibración del bol interior y al roce del granulado de mazorca maíz (producto enteramente vegetal, anti-tóxico, tratado con agentes antibacterianos), los cubiertos salen en menos de un minuto perfectamente secos y brillantes, sin manchas de cal, evitando el largo abrillantado manual. De acero inoxidable AISI 304 - dotada de lámpara UV que disminuye drásticamente la carga bacteriana presente en los cubiertos incluso después del lavado - el bol interior está revestido con una resina especial, resistente a los golpes y certificada para uso alimentario. Capacidad 50 cubiertos al minuto.

RU Столовая сушилка-полировальная машина предназначена для быстрого высыхания и полирования столовых приборов прямо из посудомоечной машины. Благодаря синергии внутренних колебаний чаши и трения порошка коронки (полностью нетоксичный, нетоксичный, обработанный специальными антибактериальными средствами продукт) столовые приборы получаются совершенно сухими и блестящими, без пятен накипи, что позволяет избежать длительного полирования вручную. Изготовлен из нержавеющей стали AISI 304 - оснащен УФ лампой, снижающей бактериальную нагрузку на столовые приборы даже после мойки - внутренняя чаша покрыта ударопрочной смолой, сертифицированной для пищевого использования - производительность 50 штук в минуту.

	<b>ALP3000</b>
	0,5 kW (0,7 HP)
 1 Ph	230V/1N/50Hz
	2,5 Kg (Tutolo di mais - Corn cob - Кукурузный гранулят)
 h/N.	3000 h/N.
	620 x 550 x 520(h) mm
	
 NET Kg	53,5 Kg
 GROSS Kg	70 Kg
	800 x 650 x 720(h) mm
	0,375 m³



# Cottura

COOKING  
CUISSON  
KOCHEŃ  
COCCIÓN  
ПРИГОТОВЛЕНИЕ

## IT

La linea cottura risponde alle esigenze di ogni tipo di richiesta, dalla più moderna cottura Sous-Vide, ai tradizionali Forni Elettrici per Pizza, Forni a Convezione o Forni a Gas, con i relativi accessori come Armadi Lievitori, Celle per la Lievitazione e Cappe a condensazione. Ma non solo, anche Cucine, Griglie a Pietra Lavica, Brasiere, Fry Top, Gyros Elettrici e a Gas, Friggitrici, Cuocipasta e Salamandre.

## FR

La ligne de cuisson répond aux besoins de chaque type de demande, de la plus moderne cuisson Sous-Vide, aux traditionnels fours à pizza électriques, fours à convection ou fours à gaz, avec les accessoires correspondants tels que les armoires de levure, cellules de levure et hottes à condensation. Non seulement cela, mais aussi des cuisinières, des grilles à pierre lavique, des sauteuses, des Fry-Tops, des gyros électriques et à gaz, des friteuses, des cuiseurs à pâtes et des salamandres.

## ES

La línea de cocción responde a diferentes necesidades, de la más moderna cocción sous-vide, a los tradicionales hornos eléctricos para pizza, hornos de convección o hornos de gas, con los relativos accesorios como armarios de fermentación, cámaras para la fermentación, campana de condensación. Además en nuestro catálogo se encuentran cocinas, parrillas, piedras lavicas, ollas de cocción lenta, Fry Top, gyros eléctricos y de gas, freidoras, cocedor de pasta y salamandras.

## EN

The cooking line meets the needs of every type of request, from the most modern Sous-Vide cooking, to the traditional Electric Pizza Ovens, Convection Ovens or Gas Ovens, with their accessories such as Proving Cabinets, Proving Cells and Condensing Hoods. Moreover, there are also ranges, lava stone grills, brat pans, fry tops, electric and gas gyros, fryers, pasta cookers and salamanders.

## DE

Die Kochlinie erfüllt die Bedürfnisse aller Arten von Anforderungen, von der modernsten Sous-Vide-Küche bis zu den traditionellen elektrischen Pizzaöfen, Konvektions- oder Gasöfen, mit dem entsprechenden Zubehör wie Gärschränke, Gärzellen und Kondensationshauben. Nicht nur das, sondern auch Herde, Lavasteingrill, Fry Tops, Elektrik- und Gasgyros, Friteusen, Pastakoher und Salamander.

## RU

Линия готовки отвечает всем требованиям, от самых современных духовых шкафов до традиционных электрических пиццерий, конвекционных и газовых печей, с соответствующими принадлежностями, такими как дрожжевые шкафы, дрожжевые камеры и конденсационные вытяжки. И не только это, но и кухни, каменные грили Lava, жаровни, жаровни, электрические и газовые гироскопы, фритюрницы, макаронные плиты и саламандры.

# SV25 RH50



RH50



SV25

Cottura sous-vide

SOUS-VIDE COOKING  
CUISSON SOUS-VIDE  
VAKUUM GAREN  
COCCIÓN SOUS-VIDE  
ВАКУУМНАЯ ВАПКА



GUARDA IL VIDEO  
WATCH THE VIDEO

 **fimar**

**IT** Macchine per la cottura sottovuoto a bassa temperatura (sous-vide). Scheda di controllo con 5 programmi di cottura - display per la visualizzazione delle temperature di acqua, sonda al cuore e timer - blocco macchina in mancanza di acqua - sensore temperatura con delta 0,1°C - precisione di lavorazione +/- 0,3°C. SV25 è dotato di vasca in acciaio inox e rubinetti di scarico con valvola di sicurezza. Il modello SV25 raggiunge i 70°C in circa 50', il modello RH50 in circa 25'.

Optional: sonda al cuore.

**EN** Low temperature vacuum cooking machine (sous-vide). Control board with 5 cooking programs - screen to display the temperature of water, core probe and timer - machine stop with no water - temperature probe with delta 0.1°C - working accuracy +/- 0.3°C. The SV25 model is equipped with casing and bowl in stainless steel and drain with safety valve. The SV25 model reaches 70°C in about 50', the RH50 model in about 25'.

Accessories: Core probe.

**FR** Machine de cuisson sous vide à basse température (sous-vide). Panneau de commande avec 5 programmes de cuisson - Écran pour visualiser la température de l'eau, de la sonde à cœur et de la minuterie - arrêt de la machine en l'absence d'eau - sonde de température avec delta 0,1°C - précision d'usinage +/- 0,3°C. Le modèle SV25 a corps et cuve en acier Inox et vidange avec soupape de sécurité. Le modèle SV25 atteint 70°C en 50' environ, le modèle RH50 en 25' environ.

Accessoires: sonde à cœur.

**DE** Niedertemperaturgargerät für das Vakuumkochen (sous-vide). Bedienfeld mit 5 Garprogrammen - Display zur Anzeige von Wassertemperaturen, Kerntemperaturfühler und Schaltuhr - Maschinenstopp bei Wasserausfall - Temperaturfühler mit Delta 0,1°C - Bearbeitungsgenauigkeit +/- 0,3°C. Gehäuse und Wanne des Modells SV25 sind aus Edelstahl, Ablaufhahn mit Sicherheitsventil. Das Modell SV25 erreicht 70°C in etwa 50', das Modell RH50 in etwa 25'.

Zubehör: Kerntemperaturfühler.

**ES** Máquina de cocción al vacío de baja temperatura (sous-vide). Cuadro de mandos con 5 programas de cocción - display para la visualización de la temperatura del agua, sonda y temporizador - bloqueo de la máquina en caso de ausencia de agua - sensor de temperatura con delta de 0,1 °C - precisión de tratamiento +/- 0,3 °C. El modelo SV25 está equipado con cuerpo y cuba en acero inoxidable y válvula de descarga con válvula de seguridad. El modelo SV25 alcanza los 70°C en unos 50', el modelo RH50 en unos 25'.

Accesorios: Sonda al corazón.

**RU** Низкотемпературная варочная панель для приготовления в вакууме (су-вид). 5 программ приготовления - Панель управления - Дисплей температуры воды, датчик температуры сердечника и таймер - Остановка прибора в случае отказа подачи воды - Датчик температуры с дельта 0,1°C - Точность обработки +/- 0,3°C. Модель SV25 оснащена корпусом и чашей из нержавеющей стали и сливным отверстием с предохранительным клапаном. Модель SV25 достигает 70°C примерно за 50 минут, модель RH50 примерно за 25 минут.

Аксессуары: Щуп продукта.

	SV25	RH50
	2 kW	
 1 Ph	230V/1N/50-60Hz	
	25 L	50 L
	640 x 350 x 330(h) mm	240 x 150 x 390(h) mm
		
 NET Kg	13 Kg	4,5 Kg
 GROSS Kg	14 Kg	6 Kg
	700 x 470 x 380(h) mm	325 x 260 x 475(h) mm
	0,125 m <sup>3</sup>	0,040 m <sup>3</sup>

# FMD - FMDW



FMD4+4



FMD4+4

Forni pizza elettrici  
digitali

DIGITAL ELECTRIC PIZZA OVENS  
FOURS À PIZZA ÉLECTRIQUES NUMÉRIQUES  
DIGITALE ELEKTRISCHE PIZZAÖFEN  
HORNOS ELÉCTRICOS DIGITALES PARA PIZZA  
ЦИФРОВЫЕ ЭЛЕКТРИЧЕСКИЕ ПЕЧИ ДЛЯ ПИЦЦЫ

IT Forni elettrici professionali per la cottura di pizza, focacce, ecc. Rivestimento frontale inox - camera di cottura interamente refrattaria - pannello comandi digitale - isolamento termico mediante rivestimento in lana di roccia - porte con vetro di ispezione in pirex - illuminazione interna. Versione forni "W" con dimensioni della camera cottura invertite (più larghi e meno profondi).

EN Professional electric ovens for baking pizza, focaccia, etc. Stainless steel front panel - fully refractory cooking chamber - digital control panel - heat insulation by means of rock wool coating - doors with pyrex inspection glass - internal lighting. "W" oven version with inverted cooking chamber dimensions (wider and narrower).

FR Fours électriques professionnels pour la cuisson de pizzas, focaccia, etc. Revêtement frontal en acier Inox - chambre de cuisson entièrement réfractaire - tableau de commande numérique - isolation thermique par revêtement en laine de roche - portes avec vitred'inspection en pyrex - éclairage intérieur. Version "W" avec chambre de cuisson inversée (plus large et moins profonde).

DE Professionelle Elektrobacköfen zum Backen von Pizza, Focaccia, usw. Edelstahl-Frontblende - voll feuerfester Garraum - digitales Bedienfeld - Wärmedämmung durch Steinwolleverkleidung - Türen mit Pyrex-Schauglas - Innenbeleuchtung. Ofenvariante "W" mit umgekehrten Garraummaßen (breiter und geringer).

ES Hornos eléctricos profesionales para hornear pizza, focaccia, etc. Revestimiento frontal de acero inoxidable - cámara de cocción totalmente refractaria - panel de control digital - aislamiento térmico mediante revestimiento de lana de roca - puertas con cristal de inspección pyrex - iluminación interior. Versión de horno "W" con cámara de cocción invertida (más ancha y menos profunda).













RU Профессиональные электрические печи для выпечки пиццы, фокаччи и т.д. Передняя облицовка из нержавеющей стали - полностью огнеупорная варочная камера - цифровая панель управления - теплоизоляция благодаря облицовке минеральной ватой - двери с закаленным смотровым стеклом - внутреннее освещение. Вариант печи "W" с инвертированными размерами варочной камеры (шире и меньше).















FMDW6+6



FMDW6+6

	FMD4	FMD4+4	FMD6	FMDW6	FMD6+6	FMDW6+6
	6 kW (1 Ph - 27A) (3 Ph - 9A)	12 kW (1 Ph - 54A) (3 Ph - 18A)	9 kW (1 Ph - 36A) (3 Ph - 12A)		18 kW (1 Ph - 72A) (3 Ph - 24A)	
	230-400V/3-3N/50-60Hz					
	230V/1N/50-60Hz					
	50+500°C					
	Digitale - Digital - Цифровой					
	720 x 720 x 140(h) mm	720 x 720 x 140(h) mm x2	720 x 1080 x 140(h) mm	1080 x 720 x 140(h) mm	720 x 1080 x 140(h) mm x2	1080 x 720 x 140(h) mm x2
	1150 x 850 x 420(h) mm	1150 x 850 x 750(h) mm	1150 x 1210 x 420(h) mm	1520 x 850 x 420(h) mm	1150 x 1210 x 750(h) mm	1520 x 850 x 750(h) mm
						
	135 Kg	235 Kg	195 Kg	200 Kg	350 Kg	365 Kg
	157 Kg	262 Kg	222 Kg	225 Kg	377 Kg	390 Kg
	1250 x 1040 x 570(h) mm	1250 x 1040 x 920(h) mm	1250 x 1400 x 570(h) mm	1650 x 1040 x 570(h) mm	1250 x 1400 x 920(h) mm	1650 x 1040 x 920(h) mm
	0,741 m³	1,196 m³	0,998 m³	0,978 m³	1,610 m³	1,579 m³



	FMD9	FMD9+9
	13,2 kW (1 Ph - 60A) (3 Ph - 20A)	26,4 kW (3 Ph - 40A)
 3 Ph	230-400V/3-3N/50-60Hz	400V/3N/50-60Hz
 1 Ph	230V/1N/50-60Hz	-
	50÷500°C	
	Digitale - Digital - Цифровой	
	1080 x 1080 x 140(h) mm	1080 x 1080 x 140(h) mm x2
 mm	1520 x 1210 x 420(h) mm	1520 x 1210 x 750(h) mm
		
 NET Kg	225 Kg	465 Kg
 GROSS Kg	275 Kg	485 Kg
 mm	1650 x 1400 x 570(h) mm	1650 x 1400 x 920(h) mm
 m <sup>3</sup>	1,317 m <sup>3</sup>	2,123 m <sup>3</sup>



# FML - FME



FME4



FML6













Forni pizza  
elettrici













ELECTRIC PIZZA OVENS  
FOURS À PIZZA ÉLECTRIQUES  
ELEKTRISCHE PIZZAÖFEN  
HORNOS ELÉCTRICOS PARA PIZZA  
ЭЛЕКТРИЧЕСКИЕ ПЕЧИ ДЛЯ ПИЦЦЫ

- IT Forni elettrici professionali per la cottura di pizza, focacce, ecc. Rivestimento frontale inox - piano di cottura refrattario - isolamento termico mediante rivestimento in lana di roccia - porte con vetro di ispezione in pirex - pirometri - illuminazione interna - 2 termostati per ogni camera. Versione forni "W" con dimensioni della camera cottura invertite (più larghi e meno profondi).
- EN Professional electric ovens for baking pizza, focaccia, etc. Stainless steel on the front - refractory cooking surface - thermal insulation by means of rock wool coating - doors with pyrex inspection glass - pyrometers - internal lighting - 2 thermostats for each chamber. "W" oven version with inverted cooking chamber dimensions (wider and narrower).
- FR Fours électriques professionnels pour la cuisson de pizzas, focaccia, etc. - Revêtement frontal en acier Inox - plaque de cuisson réfractaire - isolation thermique par laine de roche - portes avec vitre d'inspection en pyrex - pyromètres - éclairage intérieur - 2 thermostats pour chaque chambre. Version "W" avec chambre de cuisson inversée (plus large et moins profonde).
- DE Professionelle Elektrobacköfen zum Backen von Pizza, Focaccia, usw. Edelstahl-Frontblende - hitzebeständige Kochfläche - digitales Bedienfeld - Wärmedämmung durch Steinwolleverkleidung - Türen mit Pyrex-Schauglas - Pyrometer - Innenbeleuchtung - 2 Thermostate pro Garraum. Ofenvariante "W" mit umgekehrten Garraummaßen (breiter und geringer).
- ES Hornos eléctricos profesionales para hornear pizza, focaccia, etc. Revestimiento frontal de acero inoxidable - encimera refractaria - aislamiento térmico mediante revestimiento de lana de roca - puertas con cristal de inspección pyrex - pirómetros - iluminación interna - 2 termostatos para cada cámara. Versión de horno "W" con cámara de cocción invertida (más ancha y menos profunda).
- RU Профессиональные электрические печи для выпечки пиццы, фокаччи и т.д. нержавеющей сталь - огнеупорная варочная поверхность - теплоизоляция с помощью покрытия из минеральной ваты - двери с закаленным смотровым стеклом - пирометры - внутреннее освещение - по 2 термостата для каждой камеры. Вариант печи "W" с инвертированными размерами варочной камеры (шире и меньше).



FML4+4

	FML4	FML4+4	FML6	FMLW6	FML6+6	FMLW6+6	FML9	FML9+9
	6 kW (1 Ph - 27A) (3 Ph - 9A)	12 kW (1 Ph - 54A) (3 Ph - 18A)	9 kW (1 Ph - 36A) (3 Ph - 12A)		18 kW (1 Ph - 72A) (3 Ph - 24A)		13,2 kW (1 Ph - 60A) (3 Ph - 20A)	26,4 kW (3 Ph - 40A)
	230-400V/3-3N/50-60Hz							
	230V/1N/50-60Hz							-
	50+500°C							
	720 x 720 x 140(h) mm	720 x 720 x 140(h) mm x2	720 x 1080 x 140(h) mm	1080 x 720 x 140(h) mm	720 x 1080 x 140(h) mm x2	1080 x 720 x 140(h) mm x2	1080 x 1080 x 140(h) mm	1080 x 1080 x 140(h) mm x2
	1010 x 850 x 420(h) mm	1010 x 850 x 750(h) mm	1010 x 1210 x 420(h) mm	1370 x 850 x 420(h) mm	1010 x 1210 x 750(h) mm	1370 x 850 x 750(h) mm	1370 x 1210 x 420(h) mm	1370 x 1210 x 750(h) mm
								
	86 Kg	146 Kg	116 Kg	130 Kg	200 Kg	215 Kg	170 Kg	350 Kg
	108 Kg	173 Kg	143 Kg	155 Kg	231 Kg	240 Kg	190 Kg	370 Kg
	1090 x 1040 x 570(h) mm	1090 x 1040 x 920(h) mm	1090 x 1400 x 570(h) mm	1450 x 1040 x 570(h) mm	1090 x 1400 x 920(h) mm	1450 x 1040 x 920(h) mm	1450 x 1400 x 570(h) mm	1450 x 1400 x 920(h) mm
	0,657 m³	1,032 m³	0,885 m³	0,860 m³	1,389 m³	1,387 m³	1,198 m³	1,827 m³

	FME4	FME4+4	FME6	FMEW6	FME6+6	FMEW6+6	FME9	FME9+9
	4,2 kW (1 Ph - 20A) (3 Ph - 7A)	8,4 kW (1 Ph - 40A) (3 Ph - 15A)	7,2 kW (1 Ph - 30A) (3 Ph - 10A)	6,4 kW (1 Ph - 28A) (3 Ph - 10A)	14,4 kW (1 Ph - 63A) (3 Ph - 21A)	12,8 kW (1 Ph - 55A) (3 Ph - 19A)	9,6 kW (1 Ph - 42A) (3 Ph - 16A)	19,2 kW (3 Ph - 33A)
	230-400V/3-3N/50-60Hz							
	230V/1N/50-60Hz							-
	50+500°C							
	610 x 610 x 140(h) mm	610 x 610 x 140(h) mm x2	610 x 915 x 140(h) mm	915 x 610 x 140(h) mm	610 x 915 x 140(h) mm x2	915 x 610 x 140(h) mm x2	910 x 910 x 140(h) mm	910 x 910 x 140(h) mm x2
	900 x 735 x 420(h) mm	900 x 735 x 750(h) mm	900 x 1020 x 420(h) mm	1150 x 735 x 420(h) mm	900 x 1020 x 750(h) mm	1150 x 735 x 750(h) mm	1150 x 1020 x 420(h) mm	1150 x 1020 x 750(h) mm
								
	66 Kg	114 Kg	85 Kg	100 Kg	150 Kg	187 Kg	115 Kg	252 Kg
	86 Kg	139 Kg	110 Kg	125 Kg	179 Kg	212 Kg	145 Kg	275 Kg
	1000 x 960 x 570(h) mm	1000 x 960 x 920(h) mm	1210 x 960 x 570(h) mm	1250 x 960 x 570(h) mm	1210 x 960 x 920(h) mm	1250 x 960 x 920(h) mm	1210 x 1210 x 570(h) mm	1210 x 1210 x 920(h) mm
	0,547 m³	0,883 m³	0,669 m³	0,684 m³	1,068 m³	1,104 m³	0,835 m³	1,347 m³

# FYL - FES



FYL4+4



FES4













Forni pizza  
elettrici

ELECTRIC PIZZA OVENS  
FOURS À PIZZA ÉLECTRIQUES  
ELEKTRISCHE PIZZAÖFEN  
HORNOS ELÉCTRICOS PARA PIZZA  
ЭЛЕКТРИЧЕСКИЕ ПЕЧИ ДЛЯ ПИЦЦЫ

- IT Forni elettrici professionali per la cottura di pizza, focacce, ecc. Rivestimento frontale inox - piano di cottura refrattario - isolamento termico mediante rivestimento in lana di roccia - porte con vetro di ispezione in pirex - illuminazione interna - 2 termostati per ogni camera.
- EN Professional electric ovens for baking pizza, focaccia, etc. Stainless steel covering on the front - refractory cooking surface - thermal insulation by means of rock wool coating - doors with pyrex inspection glass - internal lighting - 2 thermostats for each chamber.
- FR Fours électriques professionnels pour la cuisson de pizzas, focaccia, etc. Revêtement frontal en acier Inox - plaque de cuisson réfractaire - isolation thermique par laine de roche - portes avec vitre d'inspection en pyrex - éclairage intérieur - 2 thermostats pour chaque chambre.
- DE Professionelle Elektrobacköfen zum Backen von Pizza, Focaccia, usw. Edelstahl Frontblende - hitzebeständige Kochfläche - digitales Bedienfeld - Wärmedämmung durch Steinwolleverkleidung - Türen mit Pyrex-Schauglas - Innenbeleuchtung - 2 Thermostate pro Garraum.
- ES Hornos eléctricos profesionales para hornear pizza, focaccia, etc. Revestimiento frontal de acero inoxidable - encimera refractaria - aislamiento térmico mediante revestimiento de lana de roca - puertas con cristal de inspección pyrex - iluminación interna - 2 termostatos para cada cámara.
- RU Профессиональные электрические печи для выпечки пиццы, фокачки и т.д. Нержавеющая сталь или покрытие спереди - огнеупорная варочная поверхность - теплоизоляция с помощью покрытия из минеральной ваты - двери с закаленным смотровым стеклом - внутреннее освещение - по 2 термостата для каждой камеры.



FES4+4

	FYL4	FYL4+4	FYL6	FYL6+6	FES4	FES4+4
	6 kW (1 Ph - 27A) (3 Ph - 9A)	12 kW (1 Ph - 54A) (3 Ph - 18A)	9 kW (1 Ph - 36A) (3 Ph - 12A)	18 kW (1 Ph - 72A) (3 Ph - 24A)	4,2 kW (1 Ph - 20A) (3 Ph - 7A)	8,4 kW (1 Ph - 40A) (3 Ph - 15A)
	230-400V/3-3N/50-60Hz					
	230V/1N/50-60Hz					
	50+500°C					
	720 x 720 x 140(h) mm	720 x 720 x 140(h) mm x2	720 x 1080 x 140(h) mm	720 x 1080 x 140(h) mm x2	660 x 660 x 140(h) mm	660 x 660 x 140(h) mm x2
	1010 x 850 x 420(h) mm	1010 x 850 x 750(h) mm	1010 x 1210 x 420(h) mm	1010 x 1210 x 750(h) mm	900 x 785 x 420(h) mm	900 x 785 x 750(h) mm
						
	86 Kg	146 Kg	116 Kg	200 Kg	73 Kg	123 Kg
	108 Kg	173 Kg	143 Kg	231 Kg	85 Kg	136 Kg
	1090 x 1040 x 570(h) mm	1090 x 1040 x 920(h) mm	1090 x 1400 x 570(h) mm	1090 x 1400 x 920(h) mm	990 x 960 x 580(h) mm	990 x 960 x 930(h) mm
	0,657 m³	1,032 m³	0,885 m³	1,389 m³	0,551 m³	0,883 m³



	FES6	FES6+6
	7,2 kW (1 Ph - 30A) (3 Ph - 10A)	14,4 kW (1 Ph - 63A) (3 Ph - 21A)
	230-400V/3-3N/50-60Hz	
	230V/1N/50-60Hz	
	50÷500°C	
	660 x 995 x 140(h) mm	660 x 995 x 140(h) mm x2
	900 x 1080 x 420(h) mm	900 x 1080 x 750(h) mm
		
	93 Kg	159 Kg
	106 Kg	174 Kg
	1200 x 960 x 580(h) mm	1200 x 960 x 930(h) mm
	0,668 m³	1,071 m³



# MICROV1C MICRO1C MICROV2C MICRO2C MINI



MICROV1C



MICRO1C



MICROV2C



MICRO2C

Forni pizza  
elettrici

ELECTRIC PIZZA OVENS  
FOURS À PIZZA ÉLECTRIQUES  
ELEKTRISCHE PIZZAÖFEN  
HORNOS ELÉCTRICOS PARA PIZZA  
ЭЛЕКТРИЧЕСКИЕ ПЕЧИ ДЛЯ ПИЦЦЫ

IT Forno elettrico professionale per la cottura di pizza, focacce, ecc. Rivestimento frontale inox - piano di cottura refrattario - isolamento termico mediante rivestimento in lana di roccia - 3 termostati per modello MINI - 2 termostati per modello MICROV1C - MICRO1C - 4 termostati per modello MICROV2C - MICRO2C. **MICROV1C - MICROV2C:** porte con vetro di ispezione in pirex. **MICRO1C - MICRO2C - MINI:** porta cieca.



EN Professional electric ovens for baking pizza, focaccia, etc. Stainless steel front covering - refractory cooking surface - thermal insulation by means of rock wool coating - 3 thermostats on mod. MINI - 2 thermostats on mod. MICROV1C - MICRO1C - 4 thermostats for mod. MICROV2C - MICRO2C. **MICROV1C - MICROV2C:** doors with pyrex inspection glass. **MICRO1C - MICRO2C - MINI:** blind door.

FR Fours électriques professionnels pour la cuisson de pizzas, focaccia, etc. revêtement frontal en acier Inox - plaque de cuisson réfractaire - isolation thermique par laine de roche - 3 thermostats pour le mod. MINI, 2 thermostats pour le mod. MICROV1C - MICRO1C - 4 thermostats pour le mod. MICROV2C - MICRO2C. **MICROV1C - MICROV2C:** portes avec vitre d'inspection en pyrex. **MICRO1C - MICRO2C - MINI:** porte non vitrée.

DE Professionelle Elektrobacköfen zum Backen von Pizza, Focaccia, usw. Edelstahl-Frontblende - hitzebeständige Kochfläche - Wärmedämmung durch Steinwollebeschichtung - 3 Thermostate im Mod. MINI - 2 Thermostate bei Mod. MICROV1C - MICRO1C - 4 Thermostate für Mod. MICROV2C - MICRO2C. **MICROV1C - MICROV2C:** Türen mit Pyrex-Schauglas. **MICRO1C - MICRO2C - MINI:** Blindtür

ES Hornos eléctricos profesionales para hornear pizza, focaccia, etc. Revestimiento frontal de acero inoxidable - superficie de cocción refractaria - aislamiento térmico mediante revestimiento de lana de roca - 3 termostatos en el mod. MINI - 2 termostatos en el mod. MICROV1C - MICRO1C - 4 termostatos para mod. MICROV2C - MICRO2C. **MICROV1C - MICROV2C:** puertas con cristal de inspección pyrex. **MICRO1C - MICRO2C - MINI:** puerta ciega.

RU Профессиональные электрические печи для выпечки пиццы, focaccia и др. Облицовка из нержавеющей стали - огнеупорная варочная поверхность - теплоизоляция с помощью покрытия из минеральной ваты - 3 термостата на мод. MINI - 2 термостата на мод. MICROV1C - MICRO1C - 4 термостата для мод. MICROV2C - MICRO2C. **MICROV1C - MICROV2C:** двери с закаленным смотровым стеклом. **MICRO1C - MICRO2C - MINI:** слепая дверь.

	MICROV1C MICRO1C	MICROV2C MICRO2C	MINI
			
	2,2 kW (1 Ph - 9,5A)	4,4 kW (1 Ph - 19A) (3 Ph - 9,6A)	6 kW (1 Ph - 27A) (3 Ph - 9A)
	-	230-400V/3-3N/50-60Hz	
	230V/1N/50-60Hz		
	50+500°C		
	405 x 405 x 110(h) mm	405 x 405 x 110(h) mm x2	500 x 500 x 110(h) mm
	555 x 460 x 290(h) mm	555 x 460 x 530(h) mm	780 x 600 x 530(h) mm
			
	27 Kg	54 Kg	66 Kg
	35 Kg	63 Kg	79 Kg
	620 x 620 x 450(h) mm	620 x 620 x 690(h) mm	850 x 820 x 690(h) mm
	0,173 m³	0,265 m³	0,481 m³



MINI

# MICROV18C MICROV22C



MICROV22C



MICROV18C

Forni pizza  
elettrici

ELECTRIC PIZZA OVENS  
FOURS À PIZZA ÉLECTRIQUES  
ELEKTRISCHE PIZZAÖFEN  
HORNOS ELÉCTRICOS PARA PIZZA  
ЭЛЕКТРИЧЕСКИЕ ПЕЧИ ДЛЯ ПИЦЦЫ

**IT** Forni elettrici professionali per la cottura di pizza, focacce, ecc.  
Rivestimento frontale inox - piano di cottura refrattario - isolamento termico mediante rivestimento in lana di roccia - 2 termostati - porte con vetro di ispezione in pirex. Camera di altezza 18 cm per il modello MICROV18C e 22 cm per il modello MICROV22C che è dotato di luce e pirometro.

**EN** Professional electric ovens for baking pizza, focaccia, etc.  
Stainless steel front covering - refractory cooking surface - thermal insulation by means of rock wool coating - 2 thermostats - doors with pyrex inspection glass. Chamber height 18 cm on MICROV18C and height 22 cm on mod. MICROV22C also equipped with light and pyrometer.

**FR** Fours électriques professionnels pour la cuisson de pizzas, focaccia, etc.  
Revêtement frontal en acier Inox - surface de cuisson réfractaire - isolation thermique par revêtement en laine de roche - 2 thermostats - portes avec vitre en pyrex. Hauteur de la chambre 18 cm sur le modèle MICROV18C et hauteur 22 cm sur le modèle MICROV22C équipé aussi de lumière et pyromètre.

**DE** Professionelle Elektrobacköfen zum Backen von Pizza, Focaccia, usw.  
Edelstahl-Frontblende - feuerfeste Kochfläche - Wärmedämmung durch Steinwollebeschichtung - 2 Thermostate - Türen mit Pyrex-Schauglas. Kammerhöhe 18 cm bei Modell MICROV18C und Höhe 22 cm bei Modell MICROV22C auch mit Licht und Pyrometer.

**ES** Hornos eléctricos profesionales para hornear pizza, focaccia, etc.  
Revestimiento frontal de acero inoxidable - superficie de cocción refractaria - aislamiento térmico mediante revestimiento de lana de roca - 2 termostatos - puertas con cristal de inspección pyrex. Altura de cámara 18 cm en el modelo MICROV18C y 22 cm en el modelo MICROV22C equipado con luz y pirómetro.

**RU** Профессиональные электрические печи для выпечки пиццы, фокачки и т.д. Облицовка из нержавеющей стали - огнеупорная варочная поверхность - теплоизоляция с помощью покрытия из минеральной ваты - 2 термостата - двери с закаленным смотровым стеклом. Высота камеры 18 см у модели MICROV18C и 22 см у модели MICROV22C, оснащенной подсветкой и пирометром.

	MICROV18C	MICROV22C
	2,2 kW (1 Ph - 9,5A)	
 1 Ph	230V/1N/50-60Hz	
	50÷500°C	
	405 x 405 x 180(h) mm	405 x 405 x 220(h) mm
 mm	555 x 460 x 360(h) mm	600 x 560 x 400(h) mm
		
 NET Kg	29 Kg	33 Kg
 GROSS Kg	34 Kg	40 Kg
 mm	610 x 610 x 500(h) mm	630 x 610 x 540(h) mm
 m <sup>3</sup>	0,186 m <sup>3</sup>	0,208 m <sup>3</sup>



FP



Fornetto  
per pizza

PIZZA OVEN  
FOUR À PIZZA  
PIZZAOFEN  
HORNO PARA PIZZA  
ПЕЧКА ДЛЯ ПИЦЦЫ

- IT** Fornetto per riscaldare pizze, panini, cibi precotti, toast farciti, piadine, ecc. Struttura in acciaio inox - griglia estraibile con manico pieghevole - termostato 50÷300 °C - timer 0÷15 minuti - cassetto raccolta residui di cottura.
- EN** Small oven for heating pizzas, sandwiches, pre-cooked food, stuffed toast, piadinas, etc.. Stainless steel casing - extractable grill with folding handle - thermostat 50÷300 °C - timer 0÷15 minutes - drawer for collecting cooking waste.
- FR** Petit four pour réchauffer pizzas, sandwiches, aliments pré-cuits, toasts farcis, piadinas, etc. Corps en acier Inox - grille extractible avec poignée escamotable - thermostat 50÷300 °C - minuterie 0÷15 minutes - tiroir de récolte des résidus de cuisson.
- DE** Tishofen zum Erwärmen von Pizza, Sandwiches, vorgekochten Speisen, gefülltem Toast, Piadinas, usw. Edelstahlgehäuse - herausnehmbarer Gitterrost mit Faltgriff - Thermostat 50÷300 °C - Timer 0÷15 Minuten - Kochrückständen Sammelfach.
- ES** Hornillo para calentar pizzas, bocadillos, comida precocinada, tostadas rellenas, piadinas, etc. Estructura de acero inoxidable - parrilla extraíble con mango plegable - termostato 50÷300 °C - temporizador 0÷15 minutos - cajón para recoger los residuos de la cocción.
- RU** Печь для разогревания пиццы, бутербродов, пищевых полуфабрикатов, сэндвичей, лепешек и т.п. Корпус из нержавеющей стали, выдвижная решетка со складной рукояткой, термостат 50÷300 °C - таймер 0÷15 минут, поддон для сбора отходов.

	<b>FP</b>
	1,75 kW
 1 Ph	230V/1N/50-60Hz
	50÷300°C
	Meccanico - Mechanical - Механический 0÷15'
	300 x 330 x 50(h) mm
 mm	500 x 400 x 210(h) mm
	
 NET Kg	14 Kg
 GROSS Kg	16 Kg
 mm	580 x 500 x 290(h) mm
 m <sup>3</sup>	0,084 m <sup>3</sup>

FGI4  
FGI6  
FGI9



FGI6

# Forni pizza a gas

GAS PIZZA OVENS  
FOURS À PIZZA À GAZ  
GAS PIZZAÖFEN  
HORNOS A GAS PARA PIZZA  
ПЕЧИ ДЛЯ ПИЦЦЫ



**IT** Forni a gas professionali per la cottura di pizza, focacce, ecc.  
 Rivestimento frontale inox - piano di cottura refrattario - isolamento termico mediante rivestimento in lana di roccia - porte con vetro di ispezione in pirex - accensione con piezoelettrico - alimentazione a metano, in dotazione kit G.P.L - illuminazione interna - termostato digitale - allacciamento gas 3/4"G.  
 Accessori: Raccordo antivento per migliorare la combustione - raccordo sovrapposizione 2 forni.













**EN** Professional gas ovens for baking pizza, focaccia, etc.  
 Stainless steel front covering - refractory cooking surface - thermal insulation by means of rock wool coating - doors with pyrex inspection glass - piezoelectric ignition - natural gas supply, supplied with LPG set - internal lighting - digital thermostat - 3/4 "G gas connection.  
 Accessories: windproof connection to improve combustion - overlap connection for 2 ovens.

**FR** Fours à gaz professionnels pour la cuisson de pizzas, focaccia, etc.  
 Revêtement frontal en acier Inox - surface de cuisson réfractaire - isolation thermique par revêtement en laine de roche - portes avec vitre d'inspection en pyrex - allumage piézoélectrique - alimentation gaz naturel, fournie avec kit GPL - éclairage intérieur - thermostat numérique - raccordement gaz 3/4" G.  
 Accessoires: raccord coupe-vent pour améliorer la combustion - raccord à superposition pour 2 fours.

**DE** Professionelle Gasbacköfen zum Backen von Pizza, Focaccia, usw.  
 Edelstahl-Frontblende - hitzebeständige Kochfläche - Wärmedämmung durch Steinwollebeschichtung - Türen mit Pyrex-Schauglas - piezoelektrische Zündung - Erdgasversorgung, geliefert mit LPG-Set - Innenbeleuchtung - digitaler Thermostat - 3/4 "G-Gasanschluss.  
 Zubehör: winddichte Verbindung zur Verbesserung der Verbrennung - Stapelverbindung für 2 Öfen.

**ES** Hornos profesionales a gas para hornear pizza, focaccia, etc.  
 Revestimiento frontal de acero inoxidable - superficie de cocción refractaria - aislamiento térmico mediante revestimiento de lana de roca - puertas con cristal de inspección pyrex - encendido piezoeléctrico - aprovisionamiento de gas natural, provisto con juego de GLP - iluminación interior - termostato digital - conexión de gas 3/4 "G".  
 Accesorios: conexión cortaviento para mejorar la combustión - superposición para 2 hornos.

**RU** Профессиональные газовые печи для выпечки пиццы, лепешек и т.п..  
 Фронтальная облицовка из нержавеющей стали, огнеупорная жарочная поверхность, теплоизоляционное покрытие из минеральной ваты, дверки со смотровыми окошками из стекла пирекс, пьезоэлектрическое зажигание, работа на метане, в комплекте с оснасткой для работы на сжиженном природном газе, внутренняя подсветка, цифровой термостат.  
 Комплектующие: Соединение с защитой против ветра для улучшения сгорания - соединение для вертикального размещения 2 печей.

	<b>FGI4</b>	<b>FGI6</b>	<b>FGI9</b>
	13,9 kW	18 kW	24,5 kW
 1 Ph	230V/1N/50-60Hz		
	50÷450°C		
	Digitale - Digital - Цифровой		
<b>kcal/h</b> <b>BTU/h</b>	11.954 kcal/h 47.437 BTU/h	15.480 kcal/h 61.429 BTU/h	21.070 kcal/h 83.611 BTU/h
<b>METANO</b> <b>METHANE</b> <b>METAHA</b>	G20 = 1,470 m³/h G25 = 1,710 m³/h	G20 = 1,904 m³/h G25 = 2,215 m³/h	G20 = 2,592 m³/h G25 = 3,015 m³/h
<b>GPL</b> <b>LPG</b>	G30/G31 = 1,087 Kg/h	G30/G31 = 1,408 Kg/h	G30/G31 = 1,917 Kg/h
	N° 4 (Bruciatori - Burners - Горелки)		N° 6 (Bruciatori - Burners - Горелки)
	620 x 620 x 155(h) mm	620 x 920 x 155(h) mm	920 x 920 x 155(h) mm
	1000 x 840 x 470(h) mm	1000 x 1140 x 470(h) mm	1300 x 1140 x 470(h) mm
			
 <b>NET</b> <b>Kg</b>	115 Kg	146 Kg	181 Kg
 <b>GROSS</b> <b>Kg</b>	131 Kg	163 Kg	201 Kg
 <b>mm</b>	1090 x 1040 x 640(h) mm	1070 x 1340 x 640(h) mm	1370 x 1340 x 640(h) mm
 <b>m³</b>	0,73 m³	0,92m³	1,17 m³



RSP01-02



RAV01-02



CAVALLETTO - STAND  
ПЕЧЬ ДЛЯ ПИЦЦЫ МОЛЬБЕРТ

Optional  
forni pizza

ACCESSORIES  
ACCESSOIRES  
ZUBEHÖR  
ACCESORIOS  
AKCECCYAPY

Raccordo antivento per forni a gas  
 Windproof connection for gas ovens  
 Raccord coupe-vent pour fours à gaz  
 Winddichte Verbindung für Gasöfen  
 Conexión cortaviento para hornos a gas  
 Муфта для защиты от ветра для газовых плит

	RAV01	RAV02
Mod.	FGI4 - FGI4+4 FGI6 - FGI9	FGI6+6 - FGI9+9







Raccordo per sovrapposizione forni a gas  
 Overlap connection gas ovens  
 Raccord à superposition pour fours à gaz  
 Anschluss für die Übereinanderstellung von Gasöfen  
 Superposición para hornos a gas  
 Наложение для газовых плит

	RSP01	RSP02
Mod.	FGI4+4	FGI6+6 - FGI9+9



Cavalletti per forni pizza - Stand for pizza ovens - Support pour four à pizza  
 Pizzaofen-Gestell - Caballete para hornos para pizza - Печь для пиццы мольберт

Mod.	 mm	 Kg	 Kg	 mm	 m <sup>3</sup>
CAVFOFMD4	1010 x 850 x 980(h) mm	39 Kg	40 Kg	1020 x 860 x 130(h) mm	0,114 m <sup>3</sup>
CAVFOFMD4+4	1010 x 850 x 850(h) mm				
CAVFOFMD6	1010 x 1210 x 980(h) mm	48 Kg	49 Kg	1020 x 1220 x 130(h) mm	0,162 m <sup>3</sup>
CAVFOFMD6+6	1010 x 1210 x 850(h) mm				
CAVFOFMDW6	1370 x 850 x 980(h) mm	45 Kg	46 Kg	1380 x 860 x 130(h) mm	0,154 m <sup>3</sup>
CAVFOFMDW6+6	1370 x 850 x 850(h) mm				
CAVFOFMD9	1370 x 1210 x 980(h) mm	63 Kg	64 Kg	1380 x 1220 x 130(h) mm	0,219 m <sup>3</sup>
CAVFOFMD9+9	1370 x 1210 x 850(h) mm				
CAVFOFML4	1010 x 850 x 980(h) mm	39 Kg	40 Kg	1020 x 860 x 130(h) mm	0,114 m <sup>3</sup>
CAVFOFML4+4	1010 x 850 x 850(h) mm				
CAVFOFML6	1010 x 1210 x 980(h) mm	48 Kg	49 Kg	1020 x 1220 x 130(h) mm	0,162 m <sup>3</sup>
CAVFOFML6+6	1010 x 1210 x 850(h) mm				
CAVFOFMLW6	1370 x 850 x 980(h) mm	45 Kg	46 Kg	1380 x 860 x 130(h) mm	0,154 m <sup>3</sup>
CAVFOFMLW6+6	1370 x 850 x 850(h) mm				
CAVFOFML9	1370 x 1210 x 980(h) mm	63 Kg	64 Kg	1380 x 1220 x 130(h) mm	0,219 m <sup>3</sup>
CAVFOFML9+9	1370 x 1210 x 850(h) mm				
CAVFOFME4	900 x 735 x 980(h) mm	30 Kg	31 Kg	910 x 750 x 130(h) mm	0,088 m <sup>3</sup>
CAVFOFME4+4	900 x 735 x 850(h) mm				
CAVFOFME6	900 x 1020 x 980(h) mm	38 Kg	39 Kg	910 x 1030 x 130(h) mm	0,122 m <sup>3</sup>
CAVFOFME6+6	900 x 1020 x 850(h) mm				
CAVFOFMEW6	1150 x 735 x 980(h) mm	39 Kg	40 Kg	1160 x 750 x 130(h) mm	0,113 m <sup>3</sup>
CAVFOFMEW6+6	1150 x 735 x 850(h) mm				
CAVFOFME9	1150 x 1020 x 980(h) mm	47Kg	48 Kg	1160 x 1030 x 130(h) mm	0,155 m <sup>3</sup>
CAVFOFME9+9	1150 x 1020 x 850(h) mm				

Cavalletti per forni pizza - Stand for pizza ovens - Support pour four à pizza  
 Pizaofen-Gestell - Caballete para hornos para pizza - Печь для пиццы мольберт



Mod.	 mm	 Kg	 Kg	 mm	 m <sup>3</sup>
CAVFOFYL4	1010 x 850 x 980(h) mm	39 Kg	40 Kg	1020 x 860 x 130(h) mm	0,114 m <sup>3</sup>
CAVFOFYL4+4	1010 x 850 x 850(h) mm				
CAVFOFYL6	1010 x 1210 x 980(h) mm	48 Kg	49 Kg	1020 x 1220 x 130(h) mm	0,162 m <sup>3</sup>
CAVFOFYL6+6	1010 x 1210 x 850(h) mm				
CAVFES4	900 x 785 x 980(h) mm	33 Kg	34 Kg	740 x 890 x 130(h) mm	0,085 m <sup>3</sup>
CAVFES4+4	900 x 785 x 850(h) mm	31 Kg	32 Kg		
CAVFOFES6	900 x 1080 x 980(h) mm	41 Kg	42 Kg	1020 x 890 x 130(h) mm	0,118 m <sup>3</sup>
CAVFOFES6+6	900 x 1080 x 850(h) mm	39 Kg	40 Kg		
CAVFOMINI	780 x 600 x 980(h) mm	26 Kg	27 Kg	790 x 610 x 130(h) mm	0,063 m <sup>3</sup>
CAVFGI4 CAVFGI4+4	1000 x 840 x 1000(h) mm	34 Kg	35 Kg	1020 x 770 x 130(h) mm	0,102 m <sup>3</sup>
CAVFGI6 CAVFGI6+6	1000 x 1140 x 1000(h) mm	42 Kg	43 Kg	1020 x 1070 x 130(h) mm	0,142 m <sup>3</sup>
CAVFGI9 CAVFGI9+9	1300 x 1140 x 1000(h) mm	52 Kg	53 Kg	1310 x 1070 x 130(h) mm	0,182 m <sup>3</sup>



## AV4938/67

- IT Contenitore per impasti pizza
- EN Pizza dough container
- FR Conteneur pour pâte à pizza
- DE Pizzateigbehälter



	AV4938	AV4967	AV4939 Coperchio/Cover
 cm	600 x 400 x 75(h) mm	600 x 400 x 90(h) mm	600 x 400 mm

Scopri tutti gli optional su Forcar Multiservice!  
 Discover Forcar Multiservice!











CL  
FML-FYL  
FMD-FMLW  
FME-FES  
MINI-FGI4  
FGI6-FGI9













Celle di lievitazione  
per forni pizza

PROVING CELLS FOR PIZZA OVENS  
CELLULES DE FERMENTATION  
CONTROLÉE POUR FOURS À PIZZA  
GÄRZELLEN FÜR PIZZAÖFEN  
CÉLULAS DE FERMENTACIÓN PARA HORNOS DE PIZZA  
ЯЧЕЙКИ РАССТРОЕЧНЫЕ ПЕЧЕЙ ДЛЯ ПИЦЦЫ

- IT** Celle di lievitazione per forni pizza in lamiera verniciata di nero complete di riscaldatore. Le celle sono utilizzabili come supporti per i forni in alternativa ai cavalletti.  
Accessori: porta teglie e kit ruote.
- EN** Proving cells for pizza ovens in black coated metal plate including heating unit. The cells can be used as oven supports in alternative to stands.  
Accessories: tray rack and wheel set.
- FR** Cellules de levage pour fours à pizza en tôle peinte en noir, avec chauffage. Les cellules peuvent être utilisées comme supports de four en alternative aux supports.  
Accessoires: porte plaques et jeu de roues.
- DE** Gärzellen für Pizzaöfen aus schwarz beschichteter Metallplatte inklusive Heizeinheit. Die Zellen können als Backofenstützen alternativ zum Gestell verwendet werden.  
Zubehör: Blechträger und Rädersatz.
- ES** Células de fermentación para hornos de pizza en chapa negra con unidad de calentamiento incluida. Las celdas se pueden utilizar como soportes de horno en lugar de los caballetes.  
Accesorios: porta bandejas y juego de ruedas.
- RU** Ячейки расстоечные для печей для пиццы из нержавеющей стали, окрашенной в черный цвет. Используются как опоры для печей в качестве альтернативных подставок.  
Комплектующие: держатель противней - комплект колес.

	CL FML-FYL-FMD 4	CL FML-FYL-FMD 4+4
	1,1 kW	
 1 Ph	230V/1N/50-60Hz	
	0÷90°C	
 N.	9* 11**	7* 9**
 mm	1010 x 855 x 980(h) mm	1010 x 855 x 850(h) mm
		
 NET Kg	69 Kg* 72 Kg**	64 Kg* 65 Kg**
 GROSS Kg	85 Kg* 88 Kg**	80 Kg* 81 Kg**
 mm	1090 x 1040 x 1130(h) mm	1090 x 1040 x 980(h) mm
 m <sup>3</sup>	1,280 m <sup>3</sup>	1,140 m <sup>3</sup>













	CL FML-FYL-FMD 6	CL FMLW-FMDW 6	CL FML-FYL-FMD 6+6	CL FMLW-FMDW 6+6	CL FML-FMD 9	CL FML-FMD 9+9
	1,1 kW					
	230V/1N/50-60Hz					
	0+90°C					
	9* 11**		7* 9**		9* 11**	7* 9**
	1010 x 1215 x 980(h) mm	1370 x 855 x 980(h) mm	1010 x 1215 x 850(h) mm	1370 x 855 x 850(h) mm	1370 x 1215 x 980(h) mm	1370 x 1215 x 850(h) mm
						
	85 Kg* 90 Kg**	84 Kg* 89 Kg**	78 Kg* 81 Kg**	77 Kg* 80 Kg**	104 Kg* 110 Kg**	96 Kg* 100 Kg**
	103 Kg* 108 Kg**	102 Kg* 107 Kg**	96 Kg* 99 Kg**	95 Kg* 98 Kg**	127 Kg* 133 Kg**	119 Kg* 123 Kg**
	1400 x 1090 x 1130(h) mm		1400 x 1090 x 980(h) mm		1400 x 1400 x 1130(h) mm	1400 x 1400 x 980(h) mm
	1,720 m³		1,500 m³		2,210 m³	1,920 m³











\* Con ruote.  
With wheels.  
Avec roues.  
Mit Rädern.  
Con ruedas.  
С колесами.

\*\* Senza ruote.  
Without wheels.  
Sans roues.  
Ohne Räder.  
Sin ruedas.  
Без колес.



	CL FME 4	CL FME 4+4	CL FME 6	CL FMEW 6	CL FME 6+6	CL FMEW 6+6
	1,1 kW					
	230V/1N/50-60Hz					
	0+90°C					
	9* 11**	7* 9**	9* 11**		7* 9**	
	900 x 740 x 980(h) mm	900 x 740 x 850(h) mm	900 x 1025 x 980(h) mm	1150 x 740 x 980(h) mm	900 x 1025 x 850(h) mm	1150 x 740 x 850(h) mm
						
	60 Kg* 62 Kg**	55 Kg* 56 Kg**	71 Kg* 75 Kg**	69 Kg* 73 Kg**	63 Kg* 67 Kg**	62 Kg* 65 Kg**
	74 Kg* 76 Kg**	69 Kg* 70 Kg**	87 Kg* 91 Kg**	85 Kg* 89 Kg**	79 Kg* 83 Kg**	78 Kg* 81 Kg**
	990 x 960 x 1130(h) mm	990 x 960 x 980(h) mm	1200 x 960 x 1130(h) mm		1200 x 960 x 980(h) mm	
	1,070 m³	0,930 m³	1,300 m³		1,130 m³	













	CL FME 9	CL FME 9+9	CL FES 4	CL FES 4+4	CL FES 6	CL FES 6+6	CL MINI
	1,1 kW						
	230V/1N/50-60Hz						
	0+90°C						
	9* 11**	7* 9**	9* 11**	7* 9**	9* 11**	7* 9**	9* 11**
	1150 x 1025 x 980(h) mm	1150 x 1025 x 850(h) mm	900 x 790 x 980(h) mm	900 x 790 x 850(h) mm	900 x 1085 x 980(h) mm	900 x 1085 x 850(h) mm	780 x 605 x 980(h) mm
							
	82 Kg* 88 Kg**	74 Kg* 78 Kg**	62 Kg* 64 Kg**	57 Kg* 58 Kg**	73 Kg* 77 Kg**	65 Kg* 69 Kg**	50 Kg* 52 Kg**
	105 Kg* 111 Kg**	97 Kg* 101 Kg**	76 Kg* 78 Kg**	71 Kg* 72 Kg**	89 Kg* 93 Kg**	81 Kg* 85 Kg**	60 Kg* 62 Kg**
	1200 x 1200 x 1130(h) mm	1200 x 1200 x 980(h) mm	990 x 960 x 1130(h) mm	990 x 960 x 980(h) mm	1200 x 960 x 1130(h) mm	1200 x 960 x 980(h) mm	850 x 810 x 980(h) mm
	1,630 m³	1,410 m³	1,073 m³	0,931 m³	1,301 m³	1,128 m³	0,670 m³

\* Con ruote.  
With wheels.  
Avec roues.  
Mit Rädern.  
Con ruedas.  
С колесами.

\*\* Senza ruote.  
Without wheels.  
Sans roues.  
Ohne Räder.  
Sin ruedas.  
Без колес.

- IT** Celle di lievitazione per forni pizza a gas in lamiera verniciata di nero complete di riscaldatore. Le celle sono utilizzabili come supporti per i forni in alternativa ai cavalletti.  
Accessori: porta teglie e kit ruote.
- EN** Proving cells for pizza gas ovens in black coated metal plate including heating unit. The cells can be used as oven supports in alternative to stands.  
Accessories: tray rack and wheel set.
- FR** Cellules de levage pour fours à pizza à gaz en tôle peinte en noir, avec chauffage. Les cellules peuvent être utilisées comme supports de four en alternative aux supports.  
Accessoires: porte plaques et jeu de roues.
- DE** Gärzellen für Gaspizzaöfen aus schwarz beschichteter Metallplatte inklusive Heizeinheit. Die Zellen können als Backofenstützen alternativ zum Gestell verwendet werden.  
Zubehör: Blechträger und Rädersatz.
- ES** Células de fermentación para hornos de pizza a gas en chapa negra con unidad de calentamiento incluida. Las celdas se pueden utilizar como soportes de horno en lugar de los caballetes.  
Accesorios: porta bandejas y juego de ruedas.
- RU** Ячейки расстоечные для газовых печей для пиццы из нержавеющей стали, окрашенной в черный цвет. Используются как опоры для печей в качестве альтернативных подставок.  
Комплектующие: держатель противней - комплект колес.

	CL FGI 4	CL FGI 6	CL FGI 9
	1,1 kW		
 1 Ph	230V/1N/50-60Hz		
	0÷90°C		
 N.	9* 11**		
 mm	1000 x 845 x 1000(h) mm	1000 x 1145 x 1000(h) mm	1300 x 1145 x 1000(h) mm
			
 NET Kg	67 Kg* 70 Kg**	79 Kg* 83 Kg**	91 Kg* 96 Kg**
 GROSS Kg	83 Kg* 86 Kg**	96 Kg* 100 Kg**	111 Kg* 116 Kg**
 mm	1090 x 1040 x 1130(h) mm	1340 x 1070 x 1130(h) mm	1370 x 1340 x 1130(h) mm
 m <sup>3</sup>	1,280 m <sup>3</sup>	1,620 m <sup>3</sup>	2,070 m <sup>3</sup>

\* Con ruote.  
With wheels.  
Avec roues.  
Mit Rädern.  
Con ruedas.  
С колесами.

\*\* Senza ruote.  
Without wheels.  
Sans roues.  
Ohne Räder.  
Sin ruedas.  
Без колес.

# CAPPE



FORNO CON CAPPASPIRANTE CON FILTRO A CARBONI ATTIVI  
OVEN WITH ACTIVE CARBON FILTER COOKER HOOD



FORNO CON CAPPASPIRANTE  
OVEN WITH COOKER HOOD











FILTRO A CARBONI ATTIVI  
ACTIVE CARBON FILTER

Cappe aspiranti  
forni pizza

HOODS FOR PIZZA OVENS  
HOTTES POUR FOURS À PIZZA  
DUNSTABZUGSHAUBEN FÜR PIZZAÖFEN  
CAMPANAS EXTRACTORAS PARA HORNOS DE PIZZA  
ВЫТЯЖНЫЕ КОЛПАКИ ДЛЯ ПЕЧЕЙ ДЛЯ ПИЦЦЫ

- IT** Le cappe aspiranti sono disponibili per tutti i modelli di forni elettrici (esclusi modelli MICRO, MINI e FES). Di facile installazione, prevedono una motorizzazione con tre velocità di aspirazione. Grazie all'accessorio filtro con carbone attivo è possibile utilizzarla anche senza collegarla alla canna fumaria.
- EN** Oven cooker hoods are available for all models of electric ovens (except for the series MICRO, MINI and FES). Easy to install, they are provided with a three speeds suction motor. Thanks to the active carbon filter, it is possible to use them without being connected to the chimney flue.
- FR** Les hottes aspirantes sont disponibles pour tous les modèles de fours électriques (à l'exception des séries MICRO, MINI et FES). Faciles à installer, elles sont dotées d'une motorisation à trois vitesses d'aspiration. Grâce au filtre accessoire à charbon actif, il est possible de l'utiliser sans la raccorder au conduit de la cheminée.
- DE** Die Dunstabzugshauben sind für alle Elektrobacköfen (ausgenommen Serie MICRO, MINI und FES) verfügbar. Sie sind einfach zu installieren und bieten einen Motor mit drei Absaugstärken. Dank des eingebauten Aktivkohle-Filters können sie auch ohne Anschluss an den Kamin verwendet werden.
- ES** Las campanas aspiradoras son disponibles para todos los modelos de hornos eléctricos (excepto serie MICRO, MINI y FES). De fácil instalación, tienen una motorización de tres velocidades de aspiración. Gracias al complemento filtro con carbón activo es posible utilizarlas también sin conectarlas al tubo de la chimenea.
- RU** Вытяжные колпаки имеются в наличии для всех моделей электрических печей (кроме серий MICRO, MINI и FES), Легко устанавливаются, возможны 3 скорости всасывания. Благодаря дополнительному фильтру из активированного угля, наши вытяжные колпаки не нуждаются в соединении с дымоходом.

	<b>CAPPA FML-FYL-FMD 4/4+4</b>	<b>CAPPA FML-FYL-FMD 6/6+6</b>	<b>CAPPA FML-FMD 9/9+9</b>	<b>CAPPA FMLW-FMDW 6/6+6</b>	<b>CAPPA FME 4/4+4</b>	<b>CAPPA FME 6/6+6</b>	<b>CAPPA FME 9/9+9</b>	<b>CAPPA FMEW 6/6+6</b>
	0,31 kW							
 1 Ph	230V/1N/50Hz							
	1010 x 1085 x 240(h) mm	1010 x 1445 x 240(h) mm	1370 x 1445 x 240(h) mm	1370 x 1085 x 240(h) mm	900 x 970 x 240(h) mm	900 x 1255 x 240(h) mm	1150 x 1255 x 240(h) mm	1150 x 970 x 240(h) mm
								
 NET Kg	24 Kg	30 Kg	39 Kg	30 Kg	22 Kg	24 Kg	30 Kg	23 Kg
 GROSS Kg	26 Kg	32 Kg	41 Kg	32 Kg	24 Kg	26 Kg	32 Kg	25 Kg
 mm	1030 x 1100 x 250(h) mm	1390 x 1100 x 250(h) mm	1390 x 1460 x 250(h) mm	1390 x 1100 x 250(h) mm	920 x 980 x 250(h) mm	920 x 1060 x 250(h) mm	1170 x 1060 x 250(h) mm	1170 x 980 x 250(h) mm
 m <sup>3</sup>	0,283 m <sup>3</sup>	0,382 m <sup>3</sup>	0,507 m <sup>3</sup>	0,382 m <sup>3</sup>	0,225 m <sup>3</sup>	0,244 m <sup>3</sup>	0,310 m <sup>3</sup>	0,287 m <sup>3</sup>

# SLIM6D SLIM623D

New

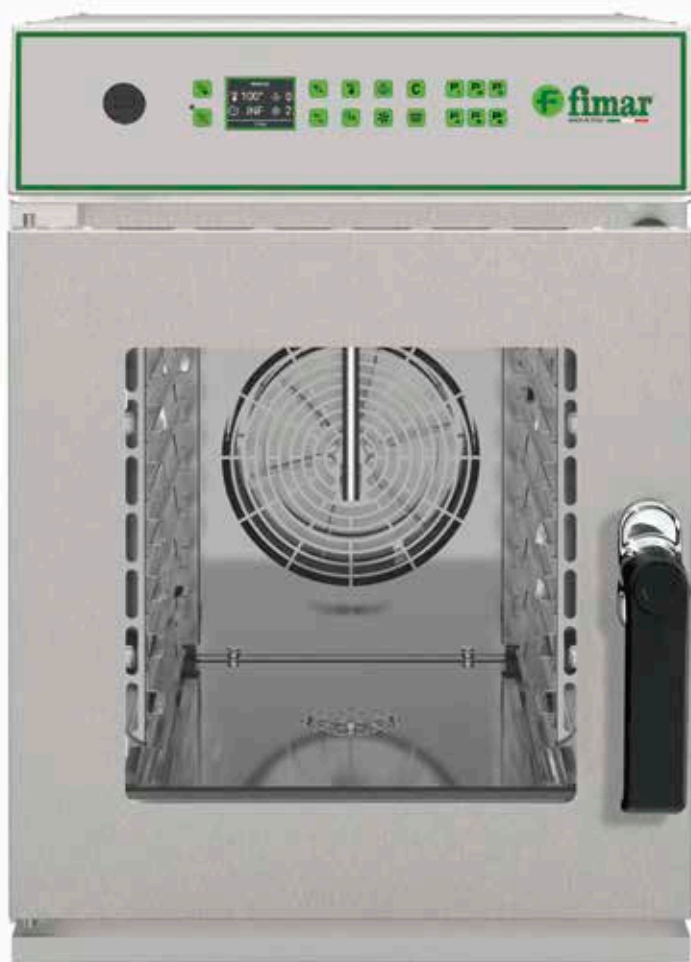

SLIM6D

Forni per gastronomia  
a convezione/vapore diretto  
digitali

GASTRONOMY OVENS DIGITAL  
FOURS GASTRONOMIE NUMÉRIQUE  
GASTRONOMIE-ÖFEN DIGITAL  
HORNOS PARA GASTRONOMÍA DIGITALES  
ГАСТРОНОМИЧЕСКИЕ ПЕЧИ ЦИФРОВЫЕ

**IT** Forni per gastronomia a convezione/vapore diretto. Struttura in acciaio inox - illuminazione interna a led - ventilatore centrifugo con autoreverse - porta con doppio vetro (vetro interno apribile) - scarico acqua - kit lavaggio interno incluso. Controllo digitale con 99 programmi - fino a 4 cicli di cottura in sequenza automatica per programma - preriscaldamento automatico - regolazione iniezione acqua digitale - sonda al cuore - regolazione ventole a 5 velocità - LCD da 2.4 pollici a colori - multi timer - connettività wifi e usb 2.0 per caricamento delle ricette.











**EN** Mixed convection/direct steam gastronomy ovens. Stainless steel casing - internal LED lamp - centrifugal fan with automatic reverse - double-glazed door (removable internal glass) - water drain - washing kit. Digital control with 99 programs - up to 4 cooking cycles in automatic sequence per program - automatic preheating - digital water injection regulation - core probe - 5-speed fan regulation - 2.4 inch colour LED - multi timer - Wi-Fi and usb 2.0 connection for uploading recipes.

**FR** Fours à convection et à vapeur directe pour la gastronomie. Corps en acier Inox - éclairage interne à LED - ventilateur centrifuge avec inverseur automatique - porte avec double vitrage (possibilité d'ouvrir le verre interne) - évacuation de l'eau - kit de lavage inclus. Commande numérique avec 99 programmes - jusqu'à 4 cycles de cuisson en séquence automatique par programme - préchauffage automatique - régulation numérique de l'injection d'eau - sonde à cœur - régulation à 5 vitesses du ventilateur - LED couleur de 2,4 pouces - minuterie multiple - connectivité wifi et USB 2.0 pour télécharger des recettes.

**DE** Heißluft-/Direktdampfbacköfen für die Gastronomie. Edelstahlgehäuse - interne Ledbeleuchtung - Zentrifugalegebläse mit automatischer Wendefunktion - Tür mit Doppelverglasung (Innenglas kann geöffnet werden) - Wasserablauf - Wasch-Set. Digitale Steuerung mit 99 Programmen - bis zu 4 Kochzyklen in automatischer Abfolge pro Programm - automatische Vorwärmung - digitale Wassereinspritzeneinstellung - Kerntemperaturfühler - Lüftereinstellung mit 5 Stufen - 2,4-Zoll-LED-Farbdisplay - Multitimer - WiFi- und USB-2.0-Anschluss zum Hochladen von Rezepten.

**ES** Hornos para gastronomía a convección/Vapor directo. Estructura de acero inoxidable - iluminación interior por LED - ventilador centrífugo con autorreversaciones - puerta con doble acristalamiento (se puede abrir el cristal interior) - drenaje de agua - kit de lavado incluido. Control digital con 99 programas - hasta 4 ciclos de cocción en secuencia automática por programa - precalentamiento automático - regulación de descarga de vapor - regulación digital de inyección de agua - sonda de corazón - regulación de ventilador de 5 velocidade - pantalla LCD en color de 2,4 pulgadas - multitemporizador - conectividad wifi y usb 2.0 para cargar recetas.

**RU** Конструкция из нержавеющей стали - светодиодное внутреннее освещение - центробежный вентилятор с автореверсированием - дверь с двойным остеклением (внутреннее стекло может быть открыто) - слив воды - комплект для внутренней промывки прилагается. Цифровое управление с 99 программами - до 4 циклов приготовления в автоматической последовательности в каждой программе - автоматический предварительный нагрев - регулирование выпуска пара - цифровое регулирование впрыска воды - датчик температуры сердечника - двухскоростное управление вентилятора - 2,4-дюймовый цветной ЖК-дисплей - мультитаймер - возможность подключения к Wi-Fi и usb 2.0 для загрузки рецептов.

	<b>SLIM6D</b>	<b>SLIM623D</b>
	6,3 kw	5,3 KW
	400V/3N/50-60Hz	
	230V/1N/50-60Hz	
	50±260°C	
	6 x GN1/1**	6 x GN2/3**
	380 x 563 x 376(h) mm	380 x 388 x 376(h) mm
	532 x 860/913 x 748(h) mm senza / con maniglia without / with handle	532 x 690/738 x 748(h) mm senza / con maniglia without / with handle
		
	72 Kg	63 Kg
	86 Kg	77 Kg
	600 x 1000 x 927(h) mm	600 x 1000 x 927 (h) mm
	0,056 m³	

\*\* Teglie non incluse.  
Trays not included.  
Plaques pas incluses.  
Bleche nicht inbegriffen.  
Bandejas no incluidas.  
Противни не входят в комплект.

# SLIM6M SLIM623M

New

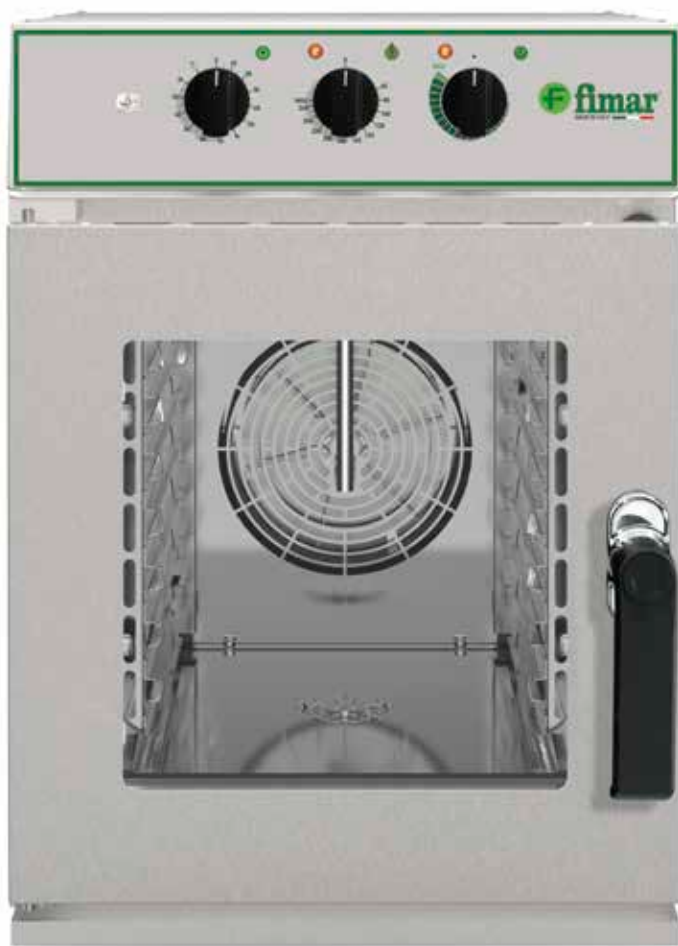

SLIM6M

Forni per gastronomia  
a convezione/vapore diretto  
meccanici

GASTRONOMY OVENS MECHANICAL  
FOURS GASTRONOMIE MÉCANIQUES  
GASTRONOMIE-ÖFEN MECHANISCH  
HORNOS PARA GASTRONOMÍA MECÁNICO  
ГASTРОНОМИЧЕСКИЕ ПЕЧИ МЕХАНИЧЕСКИЕ



- IT** Forni per gastronomia a convezione/vapore diretto. Struttura in acciaio inox - illuminazione interna a LED - ventilatore centrifugo con autoreverse - porta con doppio vetro (vetro interno apribile) - scarico acqua - umidificatore con regolatore di energia (iniezione diretta).
- EN** Mixed convection/direct steam gastronomy ovens. Stainless steel casing - internal LED lamp - centrifugal fan with automatic reverse - double-glazed door (removable internal glass) - water drain - humidifier with energy regulator (direct injection).
- FR** Fours à convection et à vapeur directe pour la gastronomie. Corps en acier Inox - éclairage interne à LED - ventilateur centrifuge avec inverseur automatique - porte avec double vitrage (possibilité d'ouvrir le verre interne) - évacuation de l'eau - humidificateur avec régulateur d'énergie (injection directe).
- DE** Heißluft-/Direktdampfbacköfen für die Gastronomie. Edelstahlgehäuse - interne Ledbeleuchtung - Zentrifugale Gebläse mit automatischer Wendefunktion - Tür mit Doppelverglasung (Innenglas kann geöffnet werden) - Wasserablauf - Befeuchter mit Energieregler (Direkteinspritzung).
- ES** Hornos para gastronomía a convección/vapor directo. Estructura de acero inoxidable - iluminación interior por LED - ventilador centrífugo con autorreversaciones - puerta con doble acristalamiento (se puede abrir el cristal interior) - drenaje de agua - humidificador con regulador de energía (inyección directa).
- RU** Конструкция из нержавеющей стали - светодиодное внутреннее освещение - центробежный вентилятор с автореверсированием - дверь с двойным остеклением (внутреннее стекло может быть открыто) - слив воды - увлажнитель с регулятором энергии (прямой впрыск).

	<b>SLIM6M</b>	<b>SLIM623M</b>
	6,3 kw	5,3 KW
	400V/3N/50-60Hz	
	230V/1N/50-60Hz	
	50±260°C	
	6 x GN1/1**	6 x GN2/3**
	380 x 563 x 376(h) mm	380 x 388 x 376(h) mm
	532 x 860/913 x 748(h) mm senza / con maniglia without / with handle	532 x 690/738 x 748(h) mm senza / con maniglia without / with handle
		
	72 Kg	63 Kg
	86 Kg	77 Kg
	600 x 1000 x 927(h) mm	600 x 1000 x 927 (h) mm
	0,056 m <sup>3</sup>	



\*\* Teglie non incluse.  
Trays not included.  
Plaques pas incluses.  
Bleche nicht inbegriffen.  
Bandejas no incluidas.  
Противни не входят в комплект.

# TOP4TN TOP6TN TOP10TN



TOP4TN



TOP6TN



TOP10TN

Forni misti touch  
convezione/vapore diretto GN1/1 60x40

MIXED OVENS WITH TOUCH CONTROLS  
FOURS MIXTES À COMMANDES TACTILES  
KOMBINIERTE "TOUCH" BACKÖFEN  
HORNOS MIXTOS CONTROLES TÁCTILES  
ПЕЧИ СМЕШАННОГО ПРИГОТОВЛЕНИЯ С  
СЕНСОРНЫМ УПРАВЛЕНИЕМ

IT Forni misti touch a convezione/vapore diretto. Struttura in acciaio inox - illuminazione interna a led - ventilatore centrifugo con autoreverse (2 ventole per il TOP4TN e per il TOP6TN, 3 ventole per il TOP10TN) - porta con doppio vetro (vetro interno apribile) - scarico acqua - kit lavaggio di serie - supporto universale per teglie GN1/1 o pasticceria 60x40 cm (teglie non incluse). Controllo touch con 120 programmi (20 ricette già registrate) - fino a 6 cicli di cottura in sequenza automatica per programma - preriscaldamento automatico - ventilatore fino a 2 velocità - regolatore del vapore - regolazione iniezione acqua digitale - sonda al cuore - gestione valvola di sfianto aperta / chiusa integrata - touch screen capacitivo da 5 pollici - connettività tramite USB 2.0.



EN Mixed convection/direct steam ovens with touch controls. Stainless steel casing - internal LED lamp - centrifugal fan with automatic reverse (2 on mod. TOP4TN and TOP6TN, 3 on mod TOP10TN) - double-glazed door (removable internal glass) - water drain - standard washing kit - universal holder for GN1/1 trays or 60x40 cm pastry trays (trays not included). Touch control with 120 programs (20 preset recipes) - up to 6 cooking cycles in automatic sequence per program - automatic preheating - double speed regulator - steam regulator - digital water injection regulation - core probe integrated open/closed air valve management - 5-inch capacitive touch screen - connectivity via USB 2.0.

FR Fours mixtes à convection et à vapeur directe avec commandes tactiles. Corps en acier inox - éclairage interne à LED - ventilateur centrifuge avec inverseur automatique (2 pour TOP4TN et TOP6TN, 3 pour TOP10TN) - porte avec double vitrage (possibilité d'ouvrir le verre interne) - évacuation de l'eau - kit de lavage de série - support universel pour bacs GN1/1 ou bacs pâtisserie 60x40 cm (bacs non fournis). Commandes tactiles avec 120 programmes (20 recettes enregistrées) - jusqu'à 6 cycles de cuisson en séquence automatique par programme - préchauffage automatique - régulateur de double vitesse - régulateur de vapeur - régulation numérique de l'injection d'eau - sonde à cœur - gestion intégrée des vannes d'air ouvertes/fermées - écran tactile capacitif de 5 pouces - connectivité via USB 2.0.

DE Kombinierte Heißluft-/Direktdampfbacköfen mit Touch-Steuerung. Edelstahlgehäuse - interne Ledbeleuchtung - Zentrifugalgebläse mit automatischer Wendefunktion - (2 für TOP4TN und TOP6TN, 3 für TOP10TN) - Tür mit Doppelverglasung (Innenglas kann geöffnet werden) - Wasserablauf - Wasch-Set als Standard - Universalhalterung für GN1/1 Bleche oder 60x40 cm Konditoreibleche (Bleche nicht inbegriffen). Touch Steuerung mit 120 Programme (20 eingetragene Rezepte) - bis zu 6 Kochzyklen in automatischer Abfolge pro Programm - automatische Vorwärmung - Dampfaustrittseinstellung - digitale Wassereinspritzeneinstellung - Kerntemperaturfühler - integriertes Management des offenen/geschlossenen Luftventils - kapazitiver 5-Zoll-Touchscreen - USB 2.0-Schnittstelle.

ES Hornos mixtos de convección/vapor directo. Estructura de acero inoxidable - iluminación interior por LED - ventilador centrifugo con autorreversaciones (2 para TOP4TN y TOP6TN, 3 para TOP10TN) - puerta con doble acristalamiento (se puede abrir el cristal interior) - drenaje de agua - kit de lavado estándar - soporte universal para bandejas GN1/1 o pastelería de 60x40 cm (bandejas no incluidas). Control táctil con 120 programas (20 recetas ya registradas) - hasta 6 ciclos de cocción en secuencia automática por programa - precalentamiento automático - regulación de descarga de vapor - regulación digital de inyección de agua - sonda de corazón - gestión integrada de válvulas de aire abiertas/cerradas - pantalla táctil capacitiva de 5 pulgadas - conectividad mediante USB 2.0.

RU Смешанные конвекционные/прямые паровые печи с сенсорным управлением. Конструкция из нержавеющей стали - светодиодное внутреннее освещение - центробежный вентилятор с автореверсированием (2 для TOP4TN и TOP6TN, 3 для TOP10TN) - дверь с двойным остеклением (внутреннее стекло может быть открыто) - слив воды - стандартный комплект для мойки - универсальная опора для лотков GN1/1 или кондитерских изделий размером 60x40 см (лотки не входят в комплект поставки). Сенсорное управление с помощью 120 программ - до 6 циклов приготовления в автоматической последовательности в каждой программе - автоматический предварительный нагрев - регулирование выпуска пара - цифровое регулирование впрыска воды - датчик температуры сердечника - интегрированное управление воздушными клапанами открытого/закрытого типа - 5-дюймовый емкостной сенсорный экран - возможность подключения через USB 2.0.

	TOP4TN	TOP6TN	TOP10TN
	10,5 kW	12,7 kW	15,7 kW
	400V/3/50Hz		
	50±260°C		
	Digitale - Digital - Цифровой 0÷120'		
	4 x 600 x 400 mm** GN1/1 - P = 80 mm	6 x 600 x 400 mm** GN1/1 - P = 80 mm	10 x 600 x 400 mm** GN1/1 - P = 80 mm
	660 x 490 x 452(h) mm	660 x 490 x 612(h) mm	660 x 490 x 948(h) mm
	937 x 821/885 x 715(h) mm senza / con maniglia without / with handle	937 x 821/885 x 875(h) mm senza / con maniglia without / with handle	937 x 827/890 x 1211(h) mm senza / con maniglia without / with handle
			
	89 Kg	98 Kg	135 Kg
	105 Kg	115 Kg	153 Kg
	1020 x 970 x 868(h) mm	1020 x 970 x 1028(h) mm	1020 x 970 x 1363(h) mm
	0,859 m <sup>3</sup>	0,100 m <sup>3</sup>	0,135 m <sup>3</sup>

\*\* Teglie non incluse.  
Trays not included.  
Plaques pas incluses.  
Bleche nicht inbegriffen.  
Bandejas no incluidas.  
Противни не входят в комплект.

# TOP4DN TOP6DN TOP10DN



TOP4DN



TOP6DN



TOP10DN

**Forni misti digitali**  
convezione/vapore diretto GN1/1 60x40

MIXED CONVECTION/DIRECT STEAM OVENS  
FOURS MIXTES À CONVECTION ET À VAPEUR DIRECTE  
KOMBINIERTHE HEISLUFT-/DIREKTDAMPFBÄCKÖFEN  
HORNOS MIXTOS CONVECCIÓN/VAPOR DIRECTO  
СМЕШАННЫЕ КОНВЕКЦИОННЫЕ/ПРЯМЫЕ ПАРОВЫЕ ПЕЧИ

**IT** Forni misti convezione/vapore diretto. Struttura in acciaio inox - illuminazione interna a LED - ventilatore centrifugo con autoreverse (2 ventole per il TOP4DN e per il TOP6DN, 3 ventole per il TOP10DN) - porta con doppio vetro (vetro interno apribile) - scarico acqua - predisposizione kit lavaggio. Controllo digitale con 99 programmi - fino a 4 cicli di cottura in sequenza automatica per programma - preriscaldamento automatico - regolazione iniezione acqua digitale - sonda al cuore - regolazione ventole a 5 velocità - sistema che velocizza l'eliminazione di umidità in camera di cottura all'occorrenza - LED da 2,4 pollici a colori - multi timer - connettività wifi e USB 2.0 per caricamento delle ricette.

**EN** Mixed convection/direct steam ovens with touch controls. Stainless steel casing - internal LED lamp - centrifugal fan with automatic reverse (2 on mod. TOP4DN and TOP6DN, 3 on mod TOP10DN) - double-glazed door (removable internal glass) - water drain - set up for washing kit. Digital control with 99 programs - up to 4 cooking cycles in automatic sequence per program - automatic preheating - steam drain regulation - digital water injection regulation - core probe - 5-speed fan regulation - system that speeds up moisture removal in the cooking chamber when needed - 2.4 inch colour LED - multi timer - Wi-Fi and USB 2.0 connection for uploading recipes.

**FR** Fours mixtes à convection et à vapeur directe avec commandes tactiles. Corps en acier Inox - éclairage interne à LED - ventilateur centrifuge avec inverseur automatique (2 pour TOP4DN et TOP6DN, 3 pour TOP10DN) - porte avec double vitrage (possibilité d'ouvrir le verre interne) - évacuation de l'eau - kit de lavage prêt à poser. Commande numérique avec 99 programmes - jusqu'à 4 cycles de cuisson en séquence automatique par programme - préchauffage automatique - régulation de l'évacuation de la vapeur - régulation numérique de l'injection d'eau - sonde à cœur - régulation à 5 vitesses du ventilateur - système qui accélère l'élimination de l'humidité dans la chambre de cuisson lorsque c'est nécessaire - LED couleur de 2,4 pouces - minuterie multiple - connectivité wifi et USB 2.0 pour télécharger des recettes.

**DE** Kombinierte Heißluft-/Direktdampfbacköfen mit Touch-Steuerung. Edelstahlgehäuse - interne Ledbeleuchtung - Zentrifugalgebläse mit automatischer Wendefunktion - (2 für TOP4DN und TOP6DN, 3 für TOP10DN) - Tür mit Doppelverglasung (Innenglas kann geöffnet werden) - Wasserablauf - Wasch-Set bereit. Digitale Steuerung mit 99 Programmen - bis zu 4 Kochzyklen in automatischer Abfolge pro Programm - automatische Vorwärmung - Dampfaustrittseinstellung - digitale Wassereinspritzeneinstellung - Kerntemperaturfühler - Lüftereinstellung mit 5 Stufen - schnelles Entfeuchtungssystem für den Gärraum - 2,4-Zoll-LED-Farbdisplay - Multitimer - WiFi- und USB-2.0-Anschluss zum Hochladen von Rezepten.

**ES** Hornos mixtos de convección/vapor directo. Estructura de acero inoxidable - iluminación interna por leds - ventilador centrifugo con autorreversaciones (2 ventiladores para TOP4DN y TOP6DN, 3 ventiladores para TOP10DN) - puerta con doble acristalamiento (se puede abrir el cristal interior) - drenaje de agua - kit de lavado listo. Control digital con 99 programas - hasta 4 ciclos de cocción en secuencia automática por programa - precalentamiento automático - control digital de la inyección de agua - sonda de corazón - control del ventilador de 5 velocidades - sistema que acelera la eliminación de la humedad en la cámara de cocción si es necesario - LED en color de 2,4 pulgadas - multitemporizador - conectividad wifi y usb 2.0 para cargar recetas.

**RU** Смешанные конвекционные/прямоточные паровые печи. Конструкция из нержавеющей стали - внутреннее светодиодное освещение - центробежный вентилятор с автореверсом (2 вентилятора для TOP4DN и TOP6DN, 3 вентилятора для TOP10DN) - дверца с двойным стеклом (внутреннее стекло можно открыть) - слив воды - предрасположенность к мытью комплекта. Цифровое управление с 99 программами - до 4 циклов приготовления в автоматической последовательности для каждой программы - автоматический предварительный нагрев - цифровой контроль впрыска воды - термощуп - 5-скоростное управление вентилятором - система, ускоряющая устранение влажности в рабочей камере при необходимости - цветной светодиодный индикатор 2,4 дюйма - мультитаймер - возможность подключения к Wi-Fi и USB 2.0 для загрузки рецептов.

	TOP4DN	TOP6DN	TOP10DN
	10,8 kW		16,1 kW
	400V/3N/50-60Hz		400V/3N/50-60Hz
	230V/1N/50-60Hz		-
	50±260°C		
	Digitale - Digital - Цифровой 0÷120'		
	4 x 600 x 400 mm** GN1/1 - P = 80 mm	6 x 600 x 400 mm** GN1/1 - P = 80 mm	10 x 600 x 400 mm** GN1/1 - P = 80 mm
	660 x 490 x 452(h) mm	660 x 490 x 612(h) mm	660 x 490 x 948(h) mm
	937 x 821/885 x 715(h) mm senza / con maniglia without / with handle	937 x 821/885 x 875(h) mm senza / con maniglia without / with handle	937 x 827/890 x 1211(h) mm senza / con maniglia without / with handle
			
	87 Kg	98 Kg	135 Kg
	103 Kg	115 Kg	153 Kg
	1020 x 970 x 868(h) mm	1020 x 970 x 1028(h) mm	1020 x 970 x 1363(h) mm
	0,860 m³	0,101 m³	0,134 m³

\*\* Teglie non incluse.  
Trays not included.  
Plaques pas incluses.  
Bleche nicht inbegriffen.  
Bandejas no incluidas.  
Противни не входят в комплект.

# TOP4M TOP6M TOP10M



TOP4M



TOP6M

















TOP10M

**Forni misti meccanici**  
convezione/vapore diretto GN1/1 60x40

MIXED CONVECTION/DIRECT STEAM OVENS  
FOURS MIXTES À CONVECTION ET À VAPEUR DIRECTE  
KOMBINIERTHE HEISLUFT-/DIREKTDAMPFBÄCKÖFEN  
HORNOS MIXTOS CONVECCIÓN/VAPOR DIRECTO  
СМЕШАННЫЕ КОНВЕКЦИОННЫЕ/ПРЯМЫЕ ПАРОВЫЕ ПЕЧИ

- IT** Forni misti convezione/vapore diretto. Struttura in acciaio inox - illuminazione interna alogena - ventilatore centrifugo con autoreverse (3 per TOP10M, 2 per TOP4M - 6M) - porta con doppio vetro (vetro interno apribile) - scarico acqua - umidificatore con regolatore di energia (iniezione diretta).
- EN** Mixed convection/direct steam ovens. Stainless steel casing - internal halogen lamp - centrifugal fan with automatic reverse (3 for TOP10M - 2 for TOP4-6M) - double-glazed door (removable internal glass) - water drain - humidifier with energy regulator (direct injection).
- FR** Fours mixtes à convection et à vapeur directe. Corps en acier Inox - éclairage interne halogène - ventilateur centrifuge avec inverseur automatique (3 pour TOP10M - 2 pour TOP4-6M) - porte avec double vitrage (possibilité d'ouvrir le verre interne) - évacuation de l'eau - humidificateur avec régulateur d'énergie (injection directe).
- DE** Kombinierte Heissluft-/Direktdampfbacköfen. Edelstahlgehäuse - interne Halogenbeleuchtung - Zentrifugalgebläse mit automatischer Wendefunktion (3 für TOP10M - 2 für TOP4-6M) - Tür mit Doppelverglasung (Innenglas kann geöffnet werden) - Wasserablauf - Befeuchter mit Energieregler (Direkteinspritzung).
- ES** Hornos mixtos de convección/vapor directo. Estructura de acero inoxidable - iluminación interior halógena - ventilador centrífugo con autorreversaciones (3 para TOP10M - 2 para TOP4-6M) - puerta con doble acristalamiento (se puede abrir el cristal interior) - drenaje de agua - humidificador con regulador de energía (inyección directa).
- RU** Смешанные конвекционные печи/с прямым паром - структура из нержавеющей стали - внутреннее галогенное освещение - центробежный вентилятор с автоматической функцией реверса (3 для TOP10M, 2 для TOP4-6M) - дверца с двойным стеклом (внутреннее стекло открывается) - слив воды - увлажнитель с регулятором энергии (прямое впрыскивание).

	TOP4M	TOP6M	TOP10M
	10,8 kW		16,1 kW
	400V/3N/50-60Hz		400V/3/50-60Hz
	230V/1N/50-60Hz		-
	50±260°C		
	Meccanico - Mechanical - Механический 0÷120'		
	4 x 600 x 400 mm** GN1/1 - P = 80 mm	6 x 600 x 400 mm** GN1/1 - P = 80 mm	10 x 600 x 400 mm** GN1/1 - P = 80 mm
	660 x 480 x 455(h) mm	660 x 480 x 615(h) mm	660 x 480 x 950(h) mm
	940 x 890 x 715(h) mm	940 x 890 x 875(h) mm	940 x 890 x 1211(h) mm
			
	87 Kg	101 Kg	135 Kg
	105 Kg	116 Kg	149 Kg
	1020 x 970 x 900(h) mm	1020 x 970 x 1000(h) mm	1020 x 970 x 1350(h) mm
	0,851 m³	0,989 m³	1,316 m³

\*\* Teglie non incluse.  
Trays not included.  
Plaques pas incluses.  
Bleche nicht inbegriffen.  
Bandejas no incluidas.  
Противни не входят в комплект.

# STR6 STR10



STR10



STR6

## Forni a convezione meccanici GN1/1 60x40

MECHANICAL CONVECTION OVENS  
FOURS À CONVECTION MÉCANIQUE  
MECHANISCHE KOMBIÖFEN  
HORNOS DE CONVECCIÓN MECÁNICA  
МЕХАНИЧЕСКИЕ КОНВЕКЦИОННЫЕ ПЕЧИ



- IT** Forni a convezione meccanici. Struttura in acciaio inox con porta doppio vetro (vetro interno apribile) - illuminazione interna alogena - umidificatore con regolatore di energia (iniezione diretta) - ventilatori centrifughi con autoreverse (3 per STR10 e 2 per STR6).
- EN** Mechanical convection ovens. Stainless steel casing with doubleglazed door (removable internal glass) - internal halogen lamp - humidifier with energy regulator (direct injection) - centrifugal fan with automatic reverse (3 for STR10 - 2 for STR6).
- FR** Fours à convection mécanique. Corps en acier Inox avec porte avec double vitrage (possibilité d'ouvrir le verre interne) - éclairage interne halogène - humidificateur avec régulateur d'énergie (injection directe) - ventilateur centrifuge avec inverseur automatique (3 pour STR10 - 2 pour STR6).
- DE** Mechanische Kombiöfen. Edelstahlgehäuse und Tür mit Doppelverglasung (Innenglas kann geöffnet werden) - interne Halogenbeleuchtung - Befeuchter mit Energieregler (Direkteinspritzung) - Zentrifugalgebläse mit automatischer Wendefunktion (3 für STR10 - 2 für STR6).
- ES** Hornos de convección mecánica. Estructura de acero inoxidable y puerta con doble acristalamiento (se puede abrir el cristal interior) - iluminación interior halógena - humidificador con regulador de energía (inyección directa) - ventilador centrífugo con autorreversaciones (3 para STR10 - 2 para STR6).
- RU** механические конвекционные печи. Конструкция из нержавеющей стали и дверь с двойным остеклением (внутреннее стекло может быть открыто) - галогенное внутреннее освещение - увлажнитель с регулятором энергии (прямое впрыскивание) - центробежный вентилятор с автореверсированием (3 для STR10 - 2 для STR6).

	STR6	STR10
	10,4 kW	16,1 kW
	400V/3N/50Hz	400V/3/50Hz
	230V/1N/50Hz	-
	50÷300°C	
	Meccanico - Mechanical - Механический 0÷120'	
	6 x 600 x 400 mm** GN1/1 - P = 80 mm	10 x 600 x 400 mm** GN1/1 - P = 80 mm
	460 x 630 x 612(h) mm	460 x 630 x 948(h) mm
	792 x 954/1021 x 941(h) mm senza / con maniglia without / with handle	793 x 954/1021 x 1277(h) mm senza / con maniglia without / with handle
		
	100 Kg	134 Kg
	115 Kg	150 Kg
	880 x 1110 x 1118(h) mm	880 x 1110 x 1456(h) mm
	1,09 m³	1,42 m³

\*\* Teglie non incluse.  
Trays not included.  
Plaques pas incluses.  
Bleche nicht inbegriffen.  
Bandejas no incluidas.  
Противни не входят в комплект.

# CMP423D CMP4GPD



Teglie incluse  
Trays included  
4 x 460 x 340 mm

CMP423D

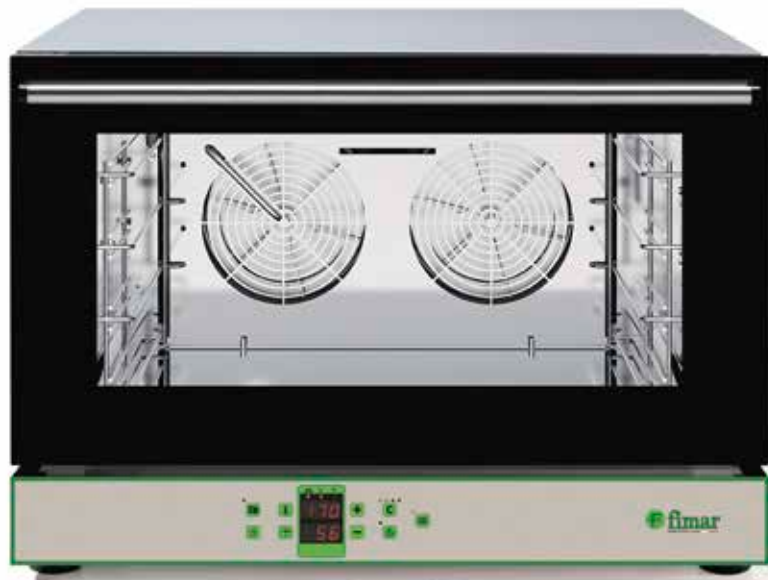

CMP4GPD

Forni a convezione  
compatti digitali

COMPACT CONVECTION OVENS  
FOURS À CONVECTION COMPACTS  
KOMPAKTE KOMBIÖFEN  
HORNOS DE CONVECCIÓN COMPACTOS  
КОМПАКТНЫЕ КОНВЕКЦИОННЫЕ ПЕЧИ

IT Forni a convezione con umidificatore. Struttura in acciaio inox - porta a ribalta - illuminazione interna alogena - porta doppio vetro - controllo digitale con 99 programmi - fino a 3 cicli di cottura in sequenza automatica - preriscaldamento automatico - regolazione iniezione acqua digitale - 2 ventilatori centrifughi con autoreverse per il CMP4GPD ed 1 ventilatore per il CMP423D.

EN Convection ovens with humidifier. Stainless steel casing - tilting door - internal halogen lamp - double-glazed door - digital control with 99 programs - up to 3 cooking cycles in automatic sequence - automatic preheating - digital water injection regulation - 2 centrifugal fans with automatic reverse on mod. CMP4GPD and 1 fan on mod. CMP423D.

FR Fours à convection avec humidificateur. Corps en acier Inox - porte basculante - éclairage halogène interne - porte à double vitrage - commande numérique avec 99 programmes - jusqu'à 3 cycles de cuisson en séquence automatique - préchauffage automatique - régulation numérique de l'injection d'eau - 2 ventilateurs centrifuges avec retour automatique pour le CMP4GPD et 1 ventilateur pour le CMP423D.

DE Heißluftöfen mit Befeuchter. Edelstahlstruktur - Klapptür - Halogen-Innenbeleuchtung - Tür mit Doppelverglasung - digitale Steuerung mit 99 Programmen - bis zu 3 Kochzyklen in automatischer Abfolge - automatische Vorwärmung - digitale Wassereinspritzeneinstellung - 2 Zentrifugalgebläse mit automatischer Wendefunktion für Mod. CMP4GPD und 1 Gebläse für Mod. CMP423D.

ES Hornos de convección con humidificador. Estructura de acero inoxidable - puerta batiente - iluminación halógena interna - con doble acristalamiento - control digital con 99 programas - hasta 3 ciclos de cocción en secuencia automática - precalentamiento automático - regulación digital de la inyección de agua - 2 ventiladores centrifugos con autorreversa para el CMP4GPD y 1 ventilador para el CMP423D.

RU Конвекционные печи с увлажнителем воздуха. Конструкция из нержавеющей стали - дверца люка - внутреннее галогенное освещение - двойное остекление - цифровое управление с 99 программами - до 3 циклов готовки в автоматической последовательности - автоматический предварительный нагрев - цифровое регулирование впрыска воды - 2 центробежных вентилятора с реверсом для CMP4GPD и 1 вентилятор для CMP423D.

	CMP423D	CMP4GPD
	3 kW	6,7 kW
	-	400V/3N/50-60Hz
	230V/1N/50-60Hz	
	50÷260°C	
	Digitale - Digital - Цифровой 0÷120'	
	4 x 460 x 340 mm*	4 x 600 x 400 mm** GN1/1 - P = 75 mm
	474 x 378 x 320(h) mm	660 x 456 x 340(h) mm
	560 x 639/683 x 530(h) mm senza / con maniglia without / with handle	750 x 708/755 x 553(h) mm senza / con maniglia without / with handle
		
	33 Kg	45 Kg
	41 Kg	50 Kg
	584 x 724 x 680(h) mm	774 x 764 x 682(h) mm
	0,287 m³	0,406 m³

\* Teglie incluse.  
Trays included.  
Plaques incluses.  
Bleche inbegriffen.  
Bandejas incluidas.  
Листы включены.

\*\* Teglie non incluse.  
Trays not included.  
Plaques pas incluses.  
Bleche nicht inbegriffen.  
Bandejas no incluidas.  
Противни не входят в комплект.

# CMP4GPM CMP4GPMI



CMP4GPM



CMP4GPMI

Forni a convezione  
compatti meccanici

COMPACT CONVECTION OVENS  
FOURS À CONVECTION COMPACTS  
KOMPAKTE KOMBIÖFEN  
HORNOS DE CONVECCIÓN COMPACTOS  
КОМПАКТНЫЕ КОНВЕКЦИОННЫЕ ПЕЧИ

- IT** Forni a convezione con umidificatore. Struttura in acciaio inox - porta a ribalta - illuminazione interna alogena - porta doppio vetro - regolazione iniezione acqua manuale - 2 ventilatori centrifughi con autoreverse per il CMP4GPMI ed 1 ventilatore per il CMP4GPM.
- EN** Convection ovens with humidifier. Stainless steel casing - tilting door - internal halogen lamp - double-glazed door - manual water injection regulation - 2 centrifugal fans with automatic reverse on mod. CMP4GPMI and 1 fan on mod. CMP4GPM.
- FR** Fours à convection avec humidificateur. Corps en acier Inox - porte basculante - éclairage halogène interne - porte à double vitrage - régulation manuelle de l'injection d'eau - 2 ventilateurs centrifuges avec retour automatique pour le CMP4GPMI et 1 ventilateur pour le CMP4GPM.
- DE** Heißluftöfen mit Befeuchter. Edelstahlstruktur - Klapptür - Halogen-Innenbeleuchtung - Tür mit Doppelverglasung - manuelle Wassereinspritzeneinstellung - 2 Zentrifugalgebläse mit automatischer Wendefunktion für Mod. CMP4GPMI und 1 Gebläse für Mod. CMP4GPM.
- ES** Hornos de convección con humidificador. Estructura de acero inoxidable - puerta batiente - iluminación halógena interna - puerta con doble acristalamiento - regulación manual de la inyección de agua - 2 ventiladores centrifugos con autorreversa para el CMP4GPMI y 1 ventilador para el CMP4GPM.
- RU** Конвекционные печи с увлажнителем воздуха. Конструкция из нержавеющей стали - распашная дверь - внутреннее галогенное освещение - дверь с двойным остеклением - ручное регулирование впрыска воды - 2 центробежных вентилятора с реверсом для CMP4GPMI и 1 вентилятор для CMP4GPM.

	<b>CMP4GPM</b>	<b>CMP4GPMI</b>
	3,4 kW	6,7 kW
	-	400V/3N/50-60Hz
	230V/1N/50-60Hz	
	50±280°C	
	Meccanico - Mechanical - Механический 0÷120'	
	4 x 600 x 400 mm** GN1/1 - P = 75 mm	
	660 x 456 x 340(h) mm	
	750 x 645/693 x 553(h) mm senza / con maniglia without / with handle	750 x 708/755 x 553(h) mm senza / con maniglia without / with handle
		
	45 Kg	
	50 Kg	
	774 x 764 x 682(h) mm	
	0,403 m³	

\*\* Teglie non incluse.  
Trays not included.  
Plaques pas incluses.  
Bleche nicht inbegriffen.  
Bandejas no incluidas.  
Противни не входят в комплект.

# CMP332M CMP423M



CMP332M















CMP423M

## Forni a convezione compatti meccanici

COMPACT CONVECTION OVENS  
FOURS À CONVECTION COMPACTS  
KOMPAKTE KOMBIÖFEN  
HORNOS DE CONVECCIÓN COMPACTOS  
КОМПАКТНЫЕ КОНВЕКЦИОННЫЕ ПЕЧИ

- IT** Forni a convezione. Struttura in acciaio inox - porta a ribalta - illuminazione interna alogena - porta doppio vetro. 4 teglie in acciaio incluse per il modello CMP423M - 3 teglie in alluminio incluse per il modello CMP332M.
- EN** Convection ovens. Stainless steel casing - tilting door - internal halogen lamp - double-glazed door. 4 steel trays included on model CMP423M - 3 aluminium trays included on model CMP332M.
- FR** Fours à convection. Corps en acier Inox - porte basculante - éclairage halogène interne - porte à double vitrage. 4 plaques en acier incluses pour le modèle CMP423M - 3 plaques en aluminium incluses pour le modèle CMP332M.
- DE** Heißluftöfen. Edelstahlstruktur - Klapptür - Halogen-Innenbeleuchtung - Tür mit Doppelverglasung. 4 Stahlbleche enthalten für Modell CMP423M - 3 Aluminiumbleche enthalten für Modell CMP332M.
- ES** Hornos de convección. Estructura de acero inoxidable - puerta batiente - iluminación halógena interna - puerta con doble acristalamiento. 4 bandejas de acero incluidas para el modelo CMP423M - 3 bandejas de aluminio incluidas para el modelo CMP332M.
- RU** Конвекционные печи. Конструкция из нержавеющей стали - распашная дверь - внутреннее галогенное освещение - дверь с двойным остеклением. 4 стальных лотка входят в комплект поставки модели CMP423M - 3 алюминиевых лотка входят в комплект поставки модели CMP332M.

	<b>CMP332M</b>	<b>CMP423M</b>
	2,9 kW	
 1 Ph	230V/1N/50Hz	
	50÷280°C	
	Meccanico - Mechanical - Механический 0÷120'	
	3 x 346 x 260 mm* GN2/3 - P = 75 mm	4 x 450 x 340 mm* GN2/3 - P = 75 mm
	379 x 338 x 245(h) mm	474 x 400 x 320(h) mm
	465 x 520/570 x 455(h) mm senza / con maniglia without / with handle	560 x 588/632 x 530(h) mm senza / con maniglia without / with handle
		
 NET Kg	25 Kg	28 Kg
 GROSS Kg	30 Kg	35 Kg
 mm	505 x 660 x 550(h) mm	584 x 724 x 680(h) mm
 m <sup>3</sup>	0,183 m <sup>3</sup>	0,284 m <sup>3</sup>

\* Teglie incluse.  
Trays included.  
Plaques incluses.  
Bleche inbegriffen.  
Bandejas incluidas.  
Листы включены.

# FN423E FN423EV



FN423E



FN423EV

Forni a convezione  
elettrici per gastronomia GN2/3

CONVECTION OVENS  
FOURS À CONVECTION  
KOMBIÖFEN  
HORNOS DE CONVECCIÓN  
КОНВЕКЦИОННЫЕ ПЕЧИ



IT Forni a convezione elettrici. Struttura in acciaio inox - illuminazione interna - 1 ventilatore centrifugo - umidificatore automatico con regolatore di energia per il mod. FN423EV - selettore a 8 funzioni (defrost, 4 modalità a convezione, 2 modalità grill, solo ventola) - porta con doppio vetro interno estraibile - guarnizione porta ad incasso - cassetto raccolta condensa estraibile - guide supporto teglie estraibili - 1 griglia compresa.





EN Electric convection ovens. Stainless steel casing - internal lighting - 1 centrifugal fan - automatic humidifier with energy regulator for model FN423EV - 8-function selector (defrost, 4 convection modes, 2 grill modes, fan only) - double-glazed door with removable internal glass - built-in door gasket - removable condensate drain drawer - removable tray slides - 1 grid included.

FR Fours électriques à convection. Structure en acier Inox - éclairage intérieur - 1 ventilateur centrifuge - humidificateur automatique avec régulateur d'énergie pour le modèle FN423EV - sélecteur 8 fonctions (dégivrage, 4 modalités de convection, 2 de grillage, ventilateur seulement) - porte avec double vitrage intérieur amovible - joint de porte intégré - bac extractible pour la récupération du condensat - glissières support plateau amovible - 1 grille en dotation.

DE Elektrische Heißluftöfen. Edelstahlgehäuse - Innenbeleuchtung - 1 Zentrifugalgebläse - automatischer Befeuchter mit Energieregler für das Modell FN423EV - 8 Funktionsschalter (Abtauen, 4 Umluftbetriebsarten, 2 Grillbetriebsarten, nur Gebläse) - Tür mit doppelt ausziehbarem Innenglas - eingebaute Türdichtung - ausziehbare Kondenswasser Sammelkasten - ausziehbare Blechführungen - 1 Gitter inbegriffen.

ES Hornos eléctricos de convección. Estructura de acero inoxidable - iluminación interior - 1 ventilador centrífugo - humidificador automático con regulador de energía para el modelo FN423EV - selector de 8 funciones (desescarche, 4 modalidades de convección, 2 modalidades de parrilla, sólo ventilador) - puerta con doble vidrio interior extraíble - junta de puerta incorporada - cajón de recogida de condensados extraíble - guías de soporte de bandeja extraíbles - 1 rejilla incluida.

RU Электрические конвекционные печи. Конструкция из нержавеющей стали - внутреннее освещение - 1 центробежный вентилятор - автоматический увлажнитель с регулятором энергии для модели FN423EV - 8-функциональный селектор (оттайка, 4 режима конвекции, 2 режима решетки, только вентилятор) - дверь с двойным извлекаемым внутренним стеклом - встроенная прокладка - выдвижной ящик для сбора конденсата - выдвижной поддон с направляющими - 1 решетка в комплекте.

	FN423E	FN423EV con umidificatore / with humidifier
	3,1 kW	
 1 Ph	230V/1N/50-60Hz	
	50÷270°C	
	Meccanico - Mechanical - Механический 0÷120'	
	4 x GN2/3** P = 75 mm	
	390 x 390 x 370(h) mm	
	620 x 600 x 580(h) mm	
		
 NET Kg	35 Kg	
 GROSS Kg	46 Kg	
 mm	680 x 680 x 785(h) mm	
 m <sup>3</sup>	0,363 m <sup>3</sup>	

\*\* Teglie non incluse.  
Trays not included.  
Plaques pas incluses.  
Bleche nicht inbegriffen.  
Bandejas no incluidas.  
Противни не входят в комплект.

# FN423M FN423MV



FN423M



FN423MV

Forni a convezione  
a gas per gastronomia GN2/3

CONVECTION OVENS  
FOURS À CONVECTION  
KOMBIÖFEN  
HORNOS DE CONVECCIÓN  
КОНВЕКЦИОННЫЕ ПЕЧИ

IT Forni a convezione a gas. Struttura in acciaio inox - illuminazione interna - porta con doppio vetro, vetro interno estraibile - guide supporto teglie estraibili - guarnizione porta ad incasso - cassetto raccolta condensa estraibile - 1 ventilatore centrifugo - umidificatore con regolazione di energia e selettore a 3 funzioni (solo per il modello FN423MV defrost, convezione, grill). Allacciamento gas 3/8"G - 1 griglia compresa.

















EN Gas convection ovens. Stainless steel casing - internal lighting - double-glazed door with removable internal glass - removable tray slides - built-in door gasket - removable condensate drain drawer - 1 centrifugal fan - humidifier with energy regulator and 3-function selector (for model FN423MV only, defrost, convection, grill). Gas connection 3/8"G - 1 grid included.

FR Fours à convection à gaz. Corps en acier inox - éclairage intérieur - porte avec double vitrage intérieur amovible - glissières support plateau amovible - joint de porte intégré - bac extractible pour la récupération du condensat - 1 ventilateur centrifuge - humidificateur avec régulateur d'énergie et sélecteur 3 fonctions (que pour le model FN423MV dégivrage, convection, grillage). Raccordement gaz 3/8"G - 1 grille en dotation.

DE Gaskonvektionsofen. Edelstahlgehäuse - Innenbeleuchtung - Tür mit doppelt ausziehbarem Innenglas - ausziehbare Blechführungen - eingebaute Türdichtung - ausziehbare Kondenswasser Sammelkasten - 1 Zentrifugalgebläse - Befeuchter mit Energieregler und 3 Funktionsschalter (nur für Model FN423MV, Abtauen, Umluftbetrieb, Grillbetrieb). Gasanschluss 3/8"G - 1 Gitter inbegriffen.

ES Hornos de convección de gas. Estructura de acero inoxidable - iluminación interior - puerta con doble vidrio interior extraíble - guías de soporte de bandeja extraíbles - junta de puerta incorporada - cajón de recogida de condensados extraíble - 1 ventilador centrífugo - humidificador automático con regulador de energía para el modelo FN423MV - selector de 3 funciones (desescarche, convección, parrilla). Conexión de gas 3/8"G - 1 rejilla incluida.

RU Газовые конвекционные печи. Конструкция из нержавеющей стали - внутреннее освещение - съемная внутренняя дверь с дв ойным остеклением - направляющие - встроенная дверная прокладка - съемный ящик для сбора конденсата - 1 центробежный вентилятор - автоматический увлажнитель с регулятором энергии для модели FN423MV -3-функциональный переключатель (оттайка, конвекция, гриль). Газовое соединение 3/8"G- 1 решетка в комплекте.

	FN423M	FN423MV con umidificatore / with humidifier
	-	1,9 kW
	4 kW	
 1 Ph	230V/1N/50-60Hz	
	50÷270°C	
	Meccanico - Mechanical - Механический 0÷120'	
	3.450 kcal/h 13662 BTU/h	
	G20 = 0,42 m³/h G25 = 0,49 m³/h	
	N° 1 (Bruciatori - Burners - Горелки)	
	4 x GN2/3** P = 75 mm	
	390 x 390 x 370(h) mm	
	620 x 645 x 615(h) mm	
		
	38 Kg	
	49 Kg	
	680 x 680 x 785(h) mm	
	0,363 m³	

\*\* Teglie non incluse.  
Trays not included.  
Plaques pas incluses.  
Bleche nicht inbegriffen.  
Bandejas no incluidas.  
Противни не входят в комплект.

# FN423G FN423GV



FN423G



FN423GV

**Forni a convezione**  
a gas per gastronomia GN2/3

CONVECTION OVENS  
FOURS À CONVECTION  
KOMBIÖFEN  
HORNOS DE CONVECCIÓN  
КОНВЕКЦИОННЫЕ ПЕЧИ

IT Forni a convezione a gas. Struttura in acciaio inox - illuminazione interna - porta con doppio vetro, vetro interno estraibile - guide supporto teglie estraibili - guarnizione porta ad incasso - cassetto raccolta condensa estraibile - 1 ventilatore centrifugo - umidificatore con regolazione di energia e selettore a 3 funzioni (solo per il modello FN423GV defrost, convezione, grill). Allacciamento gas 3/8"G - 1 griglia compresa.



















EN Gas convection ovens. Stainless steel casing - internal lighting - double-glazed door with removable internal glass - removable tray slides - built-in door gasket - removable condensate drain drawer - 1 centrifugal fan - humidifier with energy regulator and 3-function selector (for model FN423GV only, defrost, convection, grill). Gas connection 3/8"G - 1 grid included.

FR Fours à convection à gaz. Corps en acier Inox - éclairage intérieur - porte avec double vitrage intérieur amovible - glissières support plateau amovible - joint de porte intégré - bac extractible pour la récupération du condensat - 1 ventilateur centrifuge - humidificateur avec régulateur d'énergie et sélecteur 3 fonctions (que pour le model FN423GV dégivrage, convection, grillage). Raccordement gaz 3/8"G - 1 grille en dotation.

DE Gaskonvektionsofen. Edelstahlgehäuse - Innenbeleuchtung - Tür mit doppelt ausziehbarem Innenglas - ausziehbare Blechführungen - eingebaute Türdichtung - ausziehbare Kondenswasser Sammelkasten - 1 Zentrifugalgebläse - Befeuchter mit Energieregler und 3 Funktionsschalter (nur für Model FN423GV, Abtauen, Umluftbetrieb, Grillbetrieb). Gasanschluss 3/8"G - 1 Gitter inbegriffen.

ES Hornos de convección de gas. Estructura de acero inoxidable - iluminación interior - puerta con doble vidrio interior extraíble - guías de soporte de bandeja extraíbles - junta de puerta incorporada - cajón de recogida de condensados extraíble - 1 ventilador centrífugo - humidificador automático con regulador de energía para el modelo FN423GV - selector de 3 funciones (desescarche, convección, parrilla). Conexión de gas 3/8"G - 1 rejilla incluida.

RU Газовые конвекционные печи. Конструкция из нержавеющей стали - внутреннее освещение - съемная внутренняя дверь с двойным остеклением - направляющие - встроенная дверная прокладка - съемный ящик для сбора конденсата - 1 центробежный вентилятор - автоматический увлажнитель с регулятором энергии для модели FN423GV - 3-функциональный переключатель (оттайка, конвекция, гриль). Газовое соединение 3/8"G - 1 гриль входит в комплект поставки.

	FN423G	FN423GV con umidificatore / with humidifier
	-	1,9 kW
	4 kW	
 1 Ph	230V/1N/50-60Hz	
	50÷270°C	
	Meccanico - Mechanical - Механический 0÷120'	
	3.450 kcal/h 13662 BTU/h	
	GPL LPG	
	G30 = 0,29 Kg/h G31 = 0,31 Kg/h	
	N° 1 (Bruciatori - Burners - Горелки)	
	4 x GN2/3** P = 75 mm	
	390 x 390 x 370(h) mm	
	620 x 645 x 615(h) mm	
		
	NET Kg	
	GROSS Kg	
	680 x 680 x 785(h) mm	
	0,363 m <sup>3</sup>	

\*\* Teglie non incluse.  
Trays not included.  
Plaques pas incluses.  
Bleche nicht inbegriffen.  
Bandejas no incluidas.  
Противни не входят в комплект.

OPTIONAL



338

333

# FOALTOP10T FOALTOP64T FOALSTR



FOALTOP10T



FOALTOP64T

Armadi lievitatori  
per forni serie Top e Start

PROVING CABINET FOR OVENS  
ARMOIRES DE LEVAGE POUR FOURS  
GÄRSCHRÄNKE FÜR ÖFEN  
ARMARIOS FERMENTADORES PARA HORNOS  
ЯЧЕЙКИ РАССТРОЕЧНЫЕ ДЛЯ ПЕЧЕЙ

IT Armadi riscaldati/lievitori per forni. Struttura in acciaio inox e porta in vetro - termostato - bacinella per l'acqua sul fondo dell'armadio.  
**FOALTOP10T:** 12 teglie - per modello forno TOP10.  
**FOALTOP64T:** 8 teglie - per modelli forni TOP4 e TOP6.  
**FOALSTR:** 12 teglie - per modelli forni STR6 e STR10.



EN Heated/Proving cabinets for ovens. Stainless steel casing and glass door - thermostat - water basin at the bottom of the cabinet.  
**FOALTOP10T:** 12 trays - for oven model TOP10.  
**FOALTOP64T:** 8 trays - for oven models TOP4 and TOP6.  
**FOALSTR:** 12 trays - for oven models STR6 and STR10.

FR Armoires/ascenseurs chauffants pour fours. Structure en acier Inox et porte vitrée - thermostat - bac à eau au fond de l'armoire.  
**FOALTOP10T:** 12 plaques - pour le modèle TOP10.  
**FOALTOP64T:** 8 plaques - pour les modèles TOP4 et TOP6.  
**FOALSTR:** 12 plaques - pour les modèles STR6 et STR10.

DE Warmhalteschränke/Gärschränke für Öfen - Edelstahlgehäuse und Glastür - Thermostat - Wasserbehälter am Schrankboden.  
**FOALTOP10T:** 12 Bleche - für das Modell TOP10.  
**FOALTOP64T:** 8 Bleche - für die Modelle TOP4 und TOP6.  
**FOALSTR:** 12 Bleche - für die Modelle STR6 und STR10.

ES Armarios/elevadores calefaccionados para hornos. Estructura de acero inoxidable y puerta de vidrio - termostato - depósito de agua en la parte inferior del armario.  
**FOALTOP10T:** 12 bandejas - para horno modelo TOP10.  
**FOALTOP64T:** 8 bandejas - para hornos modelo TOP4 y TOP6.  
**FOALSTR:** 12 bandejas - para hornos modelo STR6 y STR10.

RU Отапливаемые шкафы/лифты для печей. Конструкция из нержавеющей стали и стеклянная дверь - термостат - водяной резервуар в нижней части шкафа.  
**FOALTOP10T:** 12 противней - для печи модели TOP10.  
**FOALTOP64T:** 8 противней - для печей моделей TOP4 и TOP6.  
**FOALSTR:** 12 противней - для печей моделей STR6 и STR10.

	FOALTOP10T	FOALTOP64T	FOALSTR
	2 kW		2,6 kW
	230V/1N/50-60Hz		
	0÷60°C		
	12 x 600 x 400 mm** GN1/1 P = 75 mm	8 x 600 x 400 mm** GN1/1 P = 75 mm	12 x 600 x 400 mm** GN1/1 P = 80 mm
	817 x 826 x 621(h) mm	625 x 713 x 707(h) mm	410 x 860 x 540(h) mm
	935 x 855 x 706(h) mm	935 x 803 x 867(h) mm	792 x 903 x 706(h) mm
			
	50 Kg	48 Kg	
	65 Kg	62 Kg	
	980 x 950 x 850(h) mm	975 x 840 x 993(h) mm	850 x 940 x 832(h) mm
	0,772 m³	0,813 m³	0,664 m³

\*\* Teglie non incluse.  
 Trays not included.  
 Plaques pas incluses.  
 Bleche nicht inbegriffen.  
 Bandejas no incluidas.  
 Противни не входят в комплект.

# FOALCMP4GP FOALCMP423



FOALCMP423



FOALCMP4GP

## Armadi lievitatori per forni CMP

PROVING CABINET FOR OVENS  
ARMOIRES DE LEVAGE POUR FOURS  
GÄRSCHRÄNKE FÜR ÖFEN  
ARMARIOS FERMENTADORES PARA HORNOS  
ЯЧЕЙКИ РАССТРОЕЧНЫЕ ДЛЯ ПЕЧЕЙ



- IT** Armadi riscaldati/lievitori per forni a convezione. Struttura in acciaio inox e porta in vetro - bacinella per l'acqua sul fondo dell'armadio.  
**FOALCMP4GP:** 8 teglie - per modelli forni CMP4GPD - CMP4GPM - CMP4GPMI.  
**FOALCMP423:** 8 teglie - per modelli forni CMP423D - CMP423M.
- EN** Heated/Proving cabinets for convection. Stainless steel casing and glass door - thermostat - water basin at the bottom of the cabinet.  
**FOALCMP4GP:** 8 trays - for ovens model CMP4GPD - CMP4GPM - CMP4GPMI.  
**FOALCMP423:** 8 trays - for ovens model CMP423D - CMP423M.
- FR** Armoires/ascenseurs chauffants pour fours à convection. Structure en acier Inox et porte vitrée - thermostat - bac à eau au fond de l'armoire.  
**FOALCMP4GP:** 8 plaques - pour les modèles CMP4GPD - CMP4GPM - CMP4GPMI.  
**FOALCMP423:** 8 plaques - pour les modèles CMP423D - CMP423M.
- DE** Warmhalteschränke/Gärschränke für Konvektions - Edelstahlgehäuse und Glastür - Thermostat - Wasserbehälter am Schrankboden.  
**FOALCMP4GP:** 8 Bleche - für die Modelle CMP4GPD - CMP4GPM - CMP4GPMI.  
**FOALCMP423:** 8 Bleche - für die Modelle CMP423D - CMP423M.
- ES** Armarios/elevadores calefaccionados para hornos de convección. Estructura de acero inoxidable y puerta de vidrio - termostato - depósito de agua en la parte inferior del armario.  
**FOALCMP4GP:** 8 bandejas - para hornos modelo CMP4GPD - CMP4GPM - CMP4GPMI.  
**FOALCMP423:** 8 bandejas - para hornos modelo CMP423D - CMP423M.
- RU** Шкафы подогрева/расстроечные для кофнлвие. Конструкция из нержавеющей стали и стеклянная дверь - термостат - водяной резервуар в нижней части шкафа.  
**FOALCMP4GP:** 8 противней - для печей моделей CMP4GPD - CMP4GPM - CMP4GPMI.  
**FOALCMP423:** 8 противней - для печей моделей CMP423D - CMP423M.

	<b>FOALCMP4GP</b>	<b>FOALCMP423</b>
	2 kW	
 1 Ph	230V/1N/50-60Hz	
	0÷60°C	
 N.	8 x 600 x 400 mm** GN1/1 P = 75 mm	8 x 450/470 x 340 mm** GN2/3 P = 75 mm
	610 x 610 x 700(h) mm	480 x 540 x 700(h) mm
 mm	800 x 690 x 860(h) mm	600 x 690 x 860(h) mm
		
 NET Kg	36 Kg	28 Kg
 GROSS Kg	50 Kg	40 Kg
 mm	860 x 800 x 1010(h) mm	660 x 700 x 1010(h) mm
 m <sup>3</sup>	0,695 m <sup>3</sup>	0,467 m <sup>3</sup>

\*\* Teglie non incluse.  
 Trays not included.  
 Plaques pas incluses.  
 Bleche nicht inbegriffen.  
 Bandejas no incluidas.  
 Противни не входят в комплект.

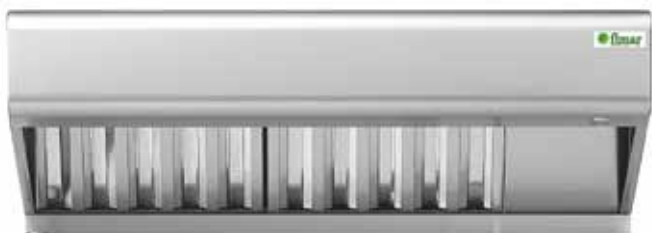

ACCAPSTR - ACCAPTOP



CAV



FOCAVCM423



FOCAVSLIM



ACKITLAV



ACDOC

# Optional forni

ACCESSORIES  
ACCESSOIRES  
ZUBEHÖR  
ACCESORIOS  
AKCECCYAPЫ







Cappa a condensazione in acciaio inox - due filtri antigrasso in acciaio inox - due velocità di estrazione.  
 Stainless steel condensing hood - two stainless steel grease filters - two extraction speeds.  
 Hotte de condensation en acier Inox - deux filtres à graisse en acier Inox - deux vitesses d'extraction.  
 Kondensationshaube aus Edelstahl - zwei Fettfilter aus Edelstahl - zwei Absauggeschwindigkeiten.  
 Campana de condensación de acero inoxidable - dos filtros antigrasa de acero inoxidable - dos velocidades de extracción.  
 Конденсационный конденсационный колпак из нержавеющей стали - два фильтра для смазки из нержавеющей стали  
 две скорости вытяжки.







Mod.	ACCAPSTR (Mod. STR6-STR10)	ACCAPTOP (Mod. TOP4M - TOP4DN - TOP6M TOP6DN- TOP10M - TOP10DN)	ACCAPTOPT (Mod. TOP4TN - TOP6TN - TOP10TN)	ACCAPSLIM23M (Mod. SLIM6D - SLIM623D SLIM6M - SLIM623M)
	0,3kW			
 1 Ph	230V/1N/50-60Hz			
	790 x 991 x 320(h) mm	937 x 892 x 323(h) mm		532 x 853 x 323(h) mm
				
 NET Kg	30 Kg	32 Kg		25 Kg
 GROSS Kg	38 Kg	39 Kg		31 Kg
 mm	800 x 1200 x 365(h) mm	1030 x 960 x 496(h) mm		1030 x 960 x 496(h) mm
 m <sup>3</sup>	0,350 m <sup>3</sup>	0,495 m <sup>3</sup>		0,490 m <sup>3</sup>

Supporti per forni con struttura in acciaio inox forniti in kit di montaggio.  
 Stainless steel supports for ovens supplied in assembly kit.  
 Supports pour fours avec structure en acier Inox fournis en kit de montage.  
 Öfengestell aus Edelstahl im Lieferumfang des Montagesatzes.  
 Soportes para hornos con estructura de acero inoxidable incluidos en el kit de montaje.  
 Опоры для печей с конструкцией из нержавеющей стали, входящей в монтажный комплект.

Mod.	FOCAVSTR STR6 - STR10	FOCAVTOP10 TOP10M - TOP10DN TOP10TN	FOCAVTOP64 TOP4M - TOP4D TOP6M - TOP6DN TOP4TN - TOP6TN	FOCAVCMP4GP CMP4GPD - CMP4GPM CMP4GPMI	FOCAVCMP423 CMP423D - CMP423M	FOCAVSLIM SLIM6D - SLIM6M
	60 x 600 x 400 mm GN1/1 P= 80 mm				60 x 450 x 340 mm P= 100 mm	6 x GN1/1
	790 x 735 x 700(h) mm	920 x 620 x 700(h) mm	920 x 620 x 800(h) mm	792 x 570 x 800(h) mm	592 x 530 x 800(h) mm	530 x 610 x 800(h) mm
	21,5 Kg	21 Kg	23 Kg	21 Kg	19 Kg	21 Kg
	22,5 Kg	22 Kg	24 Kg	22 Kg	21 Kg	23 Kg
	830 x 830 x 300(h) mm	680 x 1000 x 280(h) mm		680 x 850 x 350(h) mm	650 x 800 x 350(h) mm	680 x 1000 x 280(h) mm
	0,206 m³	0,190 m³		0,202 m³	0,182 m³	0,190 m³



	Kit lavaggio per forni Oven washing kit Kit lavage Spülkit Kit de lavado Моющий комплект
	ACKITLAV (Mod. TOPDN)
 NET Kg	2.8 Kg
 GROSS Kg	3.2 Kg
 mm	850 x 180 x 125(h) mm
 m <sup>3</sup>	0,019 m <sup>3</sup>
	

	Doccetta Shower Douchette Handbrause Ducha manual Душручной
	ACDOC (Mod. TOPM - TOPDN)
 NET Kg	1 Kg
 GROSS Kg	1.2 Kg
 mm	150 x 100 x 50(h) mm
 m <sup>3</sup>	0,001 m <sup>3</sup>
	

	<p>Rete acciaio inox per patate Stainless steel grill for potatoes Grille en acier inox pour les pommes de terre Edelstahl Gitter für Kartoffel Red de acero inoxidable para patatas Сетка из нержавеющей стали для картофеля</p>		<p>Griglia acciaio inox Stainless steel grill Grille en acier inox Edelstahl Gitter Rejilla de acero inoxidable Решётка из нерж. стали</p>		
Mod.	GNR1140 GN1/1 - 40(h) mm		GRI23 - GN2/3	GRI11 - GN1/1	GRI64 600 x 400 mm

	<p>Teglia acciaio inox Stainless steel tray Plaque en acier inox Blech aus Edelstahl Bandeja de acero inoxidable Противень из нерж. стали</p>					<p>Teglia smaltata Coated tray Plaque émaillée Beschichtetes Blech Bandeja esmaltada Противень эмалированный</p>			
Mod.	GNI2320 GN2/3 20(h) mm	GNI2340 GN2/3 40(h) mm	GNI2365 GN2/3 65(h) mm	GNI1120 GN1/1 20(h) mm	GNI1140 GN1/1 40(h) mm	GNI1165 GN1/1 65(h) mm	GNS1120 GN1/1 20(h) mm	GNS1140 GN1/1 40(h) mm	GNS1165 GN1/1 65(h) mm

	<p>Teglia alluminio Aluminium tray Plaque en aluminium Blech aus Aluminium Bandeja de aluminio Противень из алюминия</p>		<p>Teglia forata alluminio Aluminium perforated tray Plaque perforée en aluminium Gelochtes Blech aus Aluminium Bandeja perforada de aluminio Перфорированный противень из алюминия</p>		<p>Teglia alluminata Aluminium coated tray Plaque en aluminium Aluminium beschichtetes Blech Bandeja aluminad Алюминиевый противень</p>			
Mod.	AVC4940 GN1/1 20(h) mm		AV4980 600 x 400 x 20(h) mm		AVF4940 600 x 400 x 20(h) mm		AV4940 600 x 400 x 20(h) mm	

	<p>Teglia alluminio sagomata 5 baguette Shaped aluminium tray for 5 baguettes Plaque en aluminium profilée 5 baguettes Blech aus Aluminium mit Vertiefungen für 5 Baguettes Bandeja de aluminio perfilada para 5 baguette Алюминиевый противень, профилированный 5 багет</p>		<p>Teglia blurex Blurex tray Plaque blurex Blurex-Blech Bandeja de blurex Противень blurex</p>		<p>Detergente 3CLEAN tanica 3CLEAN detergent Détergent 3 CLEAN bidon Reinigungsmittel 3 CLEAN, Kanister Detergente 3CLEAN bidón Моющее средство 3CLEAN, канистра</p>	
Mod.	AVB4940		AV4937 600 x 400 x 40(h) mm		3 CLEAN - 6 Kg	

	<p>Teglia piana in alluminio  Non-stick aluminium flat baking pan  Plaque de cuisson plate en aluminium antiadhésif  Antihftbeschichtetes flaches Aluminium-Backblech  Bandeja de horno plana de aluminio antiadherente  Алюминиевый плоский противень с антипригарным покрытием</p>	<p>Teglia in alluminio antiaderente per arrosti e verdure grigliate  Non-stick aluminium pan for roasts and grilled vegetables  Plaque en aluminium antiadhésive pour les rôtis et les légumes grillés  Antihftbeschichtetes Aluminium-Backblech für Braten und gegrilltes Gemüse  Bandeja de aluminio antiadherente para asados y verduras a la parrilla  Алюминиевый противень антипригарным для приготовления жаркого и овощей на гриле</p>
Mod.	GP37 GN1/1 20(h) mm	GP38 GN1/1 20(h) mm
		

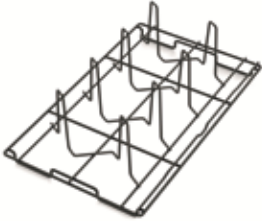
	<p>Griglia per polli in acciaio inox antiaderente  Non-stick stainless steel grid for chickens  Grille à poulets antiadhésive en acier inox  Antihft-Edelstahl-Gitter für Hähnchen  Rejilla antiadherente de acero inoxidable para pollos  Антипригарная решетка для кур из нержавеющей стали</p>
Mod.	GP65 GN1/1
	



# CC74GFEV CC76GFEV



CC74GFEV



CC76GFEV

Cucine a gas  
con forno elettrico

GAS RANGES WITH ELECTRIC OVEN  
CUISINIÈRES À GAZ AVEC FOUR ÉLECTRIQUE  
GASHERD MIT ELEKTRISCHEM OFEN  
COCINAS A GAS CON HORNO ELÉCTRICOS  
КУХНИ ГАЗОВЫХ С ЭЛЕКТРИЧЕСКОЙ ДУХОВКОЙ



IT Cucine a gas con forno elettrico. Piano di cottura in acciaio inox AISI 304 - struttura, maniglia e piedi, regolabili in altezza, in acciaio inox AISI 430 - griglie indipendenti - allacciamento gas 1/2"G - bruciatori in ghisa con termocoppia di sicurezza e accensione elettrica, predisposta per metano, kit GPL incluso - in dotazione 1 griglia in acciaio cromato. **CC74GFEV**: 4 fuochi a gas + forno elettrico GN1/1. **CC76GFEV**: 6 fuochi a gas + forno elettrico GN1/1 + vano a giorno, a richiesta con sportelli in acciaio inox.

EN Gas ranges with electric oven. Stainless steel AISI 304 cooking plate. Casing, handle and feet, height adjustable, in stainless steel AISI 430 - independent grids - gas connection 1/2"G - cast iron burners with safety thermocouple and electric ignition, natural gas ready, LPG kit included - supplied with 1 chromed steel grid. **CC74GFEV**: 4 gas burners + electric oven GN1/1. **CC76GFEV**: 6 gas burners + electric oven GN1/1 + open element, on request with stainless steel doors.

FR Cuisinières à gaz avec four électrique. Plaque de cuisson en acier Inox AISI 304. Corps, poignée et pieds, réglables en hauteur, en acier inox AISI 430 - grilles indépendantes - raccordement gaz 1/2"G - brûleurs en fonte avec thermocouple de sécurité et allumage électrique, prêts pour gaz naturel, kit GPL inclus - fournis avec 1 grille en acier chromé. **CC74GFEV**: 4 brûleurs à gaz + four électrique GN1/1. **CC76GFEV**: 6 brûleurs à gaz + four électrique GN1/1 + élément ouvert, sur demande avec portes en acier Inox.

DE Gasherde mit elektrischem Backofen. Kochplatte aus Edelstahl AISI 304. Gehäuse, Griff und Füße, höhenverstellbar, aus Edelstahl AISI 430 - unabhängige Gitter - Gasanschluss 1/2"G- Gussbrenner mit Sicherheitsthermoelement und elektrischer Zündung, erdgasbereit, LPG-Kit im Lieferumfang enthalten - geliefert mit 1 verchromten Stahlgitter. **CC74GFEV**: 4 Gasbrenner + Elektrobackofen GN1/1. **CC76GFEV**: 6 Gasbrenner + Elektrobackofen GN1/1 + offenes Element, auf Wunsch mit Edelstahltüren.

ES Cocinas a gas con horno eléctrico. Plato de cocción de acero inoxidable AISI 304. Carcasa, mango y patas, regulables en altura, en acero inoxidable AISI 430 - rejillas independientes - conexión de gas 1/2"G - quemadores de hierro fundido con termpor de seguridad y encendido eléctrico, preparados para gas natural, kit GLP incluido - suministrados con 1 rejilla de acero cromado. **CC74GFEV**: 4 quemadores de gas + horno eléctrico GN1/1. **CC76GFEV**: 6 quemadores de gas + horno eléctrico GN1/1 + elemento abierto, bajo pedido con puertas de acero inoxidable.

RU Газовых кухни с электрической духовкой. Варочная панель из нержавеющей стали AISI 304 - "Электрические плиты с духовкой". конструкция, ручка и ножки, регулируемые по высоте, из нержавеющей стали AISI 430 - решетки независимые - газовое соединение 1/2"G - чугунные горелки с термпарой безопасностью и электрическое зажигание, приготовленные для метана, комплект для сжиженного природного газа входит в комплект поставки - в комплектации поставляется с 1 решеткой из хромированной стали. **CC74GFEV**: 4 газовые горелки + электрическая печь GN1/1. **CC76GFEV**: 6 газовых горелок + электрическая печь GN1/1 + открытый отсек - по запросу. с дверями из нержавеющей стали.

Potenza  
Power  
Puissance  
Leistung  
Potencia  
Мощность

CC74GFEV		CC76GFEV		
6 kW	3,5 kW	6 kW	3,5 kW	6 kW
3,5 kW	6 kW	3,5 kW	6 kW	3,5 kW

	CC74GFEV	CC76GFEV
	3 kW (Forno - Oven - Печь)	
	19 kW (Top - Top power - мощность плиты)	28,5 kW (Top - Top power - мощность плиты)
	230V/1N/50-60Hz	
	50÷275°C	
	Meccanico - Mechanical - Механический 0÷120'	
	18916 kcal/h 75065 BTU/h	27085 kcal/h 107482 BTU/h
	G20/25 = 2,00 m³/h	G20/25 = 3,00 m³/h
	G30/31 = 1,50 Kg/h	G30/31 = 2,25 Kg/h
	4 x GN1/1 638 x 394 x 356(h) mm	
	800 x 700 x 900(h) mm	1200 x 700 x 900(h) mm
	72 Kg	91 Kg
	82 Kg	105 Kg
	860 x 760 x 915(h) mm	1260 x 760 x 915(h) mm
	0,600 m³	0,871 m³

\*Con sportelli in acciaio inox / With stainless steel doors / Avec portes en acier Inox / Mit Edelstahltüren / Con puertas de acero inoxidable / С дверями из нержавеющей стали.

CC74GFG  
CC76GFG



CC74GFG



CC76GFG

Cucine a gas  
con forno a gas

GAS RANGES WITH OVEN  
CUISINIÈRES À GAZ AVEC FOUR  
GASHERD MIT OFEN  
COCINAS A GAS CON HORNO  
ГАЗОВАЯ ПЛИТА С ДУХОВКОЙ

IT Cucine a gas con forno. Piano di cottura in acciaio inox AISI 304 - struttura, maniglia e piedi, regolabili in altezza, in acciaio inox AISI 430 - griglie indipendenti - allacciamento gas 1/2"G - bruciatori in ghisa con termocoppia di sicurezza e accensione elettrica, predisposte per metano, kit GPL incluso - in dotazione 1 griglia in acciaio cromato. **CC74GFG**: 4 fuochi a gas + forno a gas GN1/1. **CC76GFG**: 6 fuochi a gas + forno a gas GN1/1 + vano a giorno, a richiesta con sportelli in acciaio inox.

EN Gas ranges with oven. Stainless steel AISI 304 cooking plate. Casing, handle and feet, height adjustable, in stainless steel AISI 430 - independent grids - gas connection 1/2"G - cast iron burners with safety thermocouple and electric ignition, natural gas ready, LPG kit included - supplied with 1 chromed steel grid. **CC74GFG**: 4 gas burners + gas oven GN1/1. **CC76GFG**: 6 gas burners + gas oven GN1/1 + open element, on request with stainless steel doors.

FR Cuisinières à Gaz avec four. Plaque de cuisson en acier Inox AISI 304. Corps, poignée et pieds, réglables en hauteur, en acier inox AISI 430 - grilles indépendantes - raccordement gaz 1/2"G - brûleurs en fonte avec thermocouple de sécurité et allumage électrique, prêts pour gaz naturel, kit GPL inclus - fournis sur demande avec portes en acier Inox. **CC74GFG**: 4 brûleurs à gas+ four à gas GN1/1. **CC76GFG**: 6 brûleurs à gas+ four à gas GN1/1+ élément ouvert, sur demande avec portes en acier inox.















DE Gasherde mit Backofen. Kochplatte aus Edelstahl AISI 304. Gehäuse, Griff und Füße, höhenverstellbar, aus Edelstahl AISI 430 - unabhängige Gitter - Gasanschluss 1/2"G - Gussbrenner mit Sicherheitsthermoelement und elektrischer Zündung, erdgasbereit, LPG-Kit im Lieferumfang enthalten - geliefert mit 1 verchromten Stahlgitter. **CC74GFG**: 4 Gasbrenner + Gasofen GN1/1. **CC76GFG**: 6 Gasbrenner + Gasofen GN1/1 + offenes Element, auf Wunsch mit Edelstahltüren.

ES Cocinas a gas con horno. Plato de cocción de acero inoxidable AISI 304. Carcasa, mango y patas, regulables en altura, en acero inoxidable AISI 430 - rejillas independientes - conexión de gas 1/2"G - quemadores de hierro fundido con termpor de seguridad y encendido eléctrico, preparados para gas natural, kit GLP incluido - suministrados con 1 rejilla de acero cromado. **CC74GFG**: 4 quemadores de gas + horno a gas GN1/1. **CC76GFG**: 6 quemadores de gas + horno a gas GN1/1 + elemento abierto, bajo pedido con puertas de acero inoxidable.

RU Газовые плиты с духовкой. Варочная панель из нержавеющей стали AISI 304 - "Электрические плиты с духовкой". конструкция, ручка и ножки, регулируемые по высоте, из нержавеющей стали AISI 430 - решетки независимые - газовое соединение 1/2"G - чугунные горелки с термопарой безопасность и электрическое зажигание, приготовленные для метана, комплект для сжиженного природного газа входит в комплект поставки - в комплектацию поставляется с 1 решеткой из хромированной стали. **CC74GFG**: 4 газовые горелки + газовая печь GN1/1. **CC76GFG**: 6 газовых горелок + газовая печь GN1/1 + открытый элемент, с дверцами из нержавеющей стали по запросу.

Potenza  
Power  
Puissance  
Leistung  
Potencia  
Мощность

CC74GFG		CC76GFG		
6 kW	3,5 kW	6 kW	3,5 kW	6 kW
3,5 kW	6 kW	3,5 kW	6 kW	3,5 kW

	CC74GFG	CC76GFG
		
	4 kW (Forno - Oven - Печь)	
	19 kW (Top - Top power - мощность плиты)	28,5 kW (Top - Top power - мощность плиты)
	230V/1N/50-60Hz	
	50÷275°C	
	Meccanico - Mechanical - Механический 0÷120'	
	19777 kcal/h 78478 BTU/h	22356 kcal/h 88713 BTU/h
	G20/25 = 2,43 m³/h	G20/25 = 3,44 m³/h
	G30/31 = 1,80 Kg/h	G30/31 = 2,56 Kg/h
	4 x GN1/1 635 x 354 x 390h (mm)	
	800 x 700 x 900(h) mm	1200 x 700 x 900(h) mm
		
	75 Kg	94 Kg
	85 Kg	108 Kg
	860 x 760 x 915(h) mm	1260 x 760 x 915(h) mm
	0,595 m³	0,871 m³

\*Con sportelli in acciaio inox / With stainless steel doors / Avec portes en acier Inox / Mit Edelstahltüren / Con puertas de acero inoxidable / С дверями из нержавеющей стали.

# CC74G-CC76G CC74P



CC74G



CC74P



CC76G

Cucine  
senza forno

RANGES WITHOUT OVEN  
CUISINIÈRES SANS FOUR  
HERDE OHNE OFEN  
COCINAS SIN HORNO  
ПЛИТА БЕЗ ДУХОВКИ

IT Cucine senza forno. Piano di cottura in acciaio inox AISI 304 - struttura, maniglia e piedi, regolabili in altezza, in acciaio inox AISI 430 - griglie indipendenti. Allacciamento gas 1/2"G - bruciatori in ghisa con termocoppia di sicurezza e accensione elettrica predisposte per metano, kit GPL incluso. Tutti i modelli a richiesta con sportello in acciaio inox.

**CC74G:** 4 fuochi a gas + vano a giorno.

**CC76G:** 6 fuochi a gas + vano a giorno.

**CC74P:** 4 piastre elettriche da ø 220 mm + vano a giorno.

EN Gas ranges without oven. Stainless steel AISI 304 cooking plate. Casing, handle and feet, height adjustable, in stainless steel AISI 430 - independent grids. Gas connection 1/2"G - cast iron burners with safety thermocouple and electric ignition, natural gas ready, LPG kit included. All models can be delivered on request with stainless steel doors.

**CC74G:** 4 gas burners + open element.

**CC76G:** 6 gas burners + open element.

**CC74P:** 4 electric plates ø 220 mm + open element.

FR Cuisinières à Gaz. Plaque de cuisson en acier Inox AISI 304. Corps, poignée et pieds, réglables en hauteur, en acier inox AISI 430 - grilles indépendantes - raccordement gaz 1/2"G - brûleurs en fonte avec thermocouple de sécurité et allumage électrique, prêts pour gaz naturel, kit GPL inclus - fournis sur demande avec portes en acier Inox.

**CC74G:** 4 brûleurs à gaz + élément neutre.

**CC76G:** 6 brûleurs à gaz + élément neutre.

**CC74P:** 4 plaques électriques ø 220 mm + élément neutre.

DE Gasherde. Kochplatte aus Edelstahl AISI 304. Gehäuse, Griff und Füße, höhenverstellbar, aus Edelstahl AISI 430 - unabhängige Gitter - Gasanschluss 1/2"G - Gussbrenner mit Sicherheitsthermoelement und elektrischer Zündung, erdgasbereit, LPG-Kit im Lieferumfang enthalten. Alle Modelle sind auf Anfrage mit Edelstahltür erhältlich.

**CC74G:** 4 Gasbrenner + offenes Element.

**CC76G:** 6 Gasbrenner + offenes Element.

**CC74P:** 4 Elektroplatten ø 220 mm + offenes Element.

ES Cocinas a gas. Plato de cocción de acero inoxidable AISI 304. Carcasa, mango y patas, regulables en altura, en acero inoxidable AISI 430 - rejillas independientes - conexión de gas 1/2"G - quemadores de hierro fundido con termopar de seguridad y encendido eléctrico, preparados para gas natural, kit GLP incluido. Todos los modelos se fabrican con puertas de acero inoxidable bajo pedido.

**CC74G:** 4 quemadores de gas + elemento abierto.

**CC76G:** 6 quemadores de gas + elemento abierto.

**CC74P:** 4 placas eléctricas ø 220 mm + elemento abierto.

RU Газовые плиты с. Варочная панель из нержавеющей стали AISI 304 - "Электрические плиты с духовкой". конструкция, ручка и ножки, регулируемые по высоте, из нержавеющей стали AISI 430 - решетки независимые - газовое соединение 1/2"G - чугунные горелки с термопарой безопасность и электрическое зажигание, приготовленные для метана, комплект для сжиженного природного газа входит в комплект поставки. Все модели по запросу поставляются с дверцей из нержавеющей стали.

**CC74G:** 4 газовые горелки + открытый элемент.

**CC76G:** 6 газовых горелок + открытый элемент.

**CC74P:** 4 электрические пластины ø 220 мм + открытый элемент.

	CC74G	CC76G	CC74P
	-	-	10,4 kW
	19 kW	28,5 kW	
	-	-	400V/3N/50-60Hz
	230V/1N/50-60Hz		-
	16337 Kcal/h 64830 BTU/h	24505 Kcal/h 97244 BTU/h	-
	G20/25 = 2,00 m³/h	G20/25 = 3,00 m³/h	-
	G30/31 = 1,50 Kg/h	G30/31 = 2,25 Kg/h	-
	800 x 700 x 900(h) mm	1200 x 700 x 900(h) mm	800 x 700 x 900(h) mm
			
	62 Kg	94 Kg	55 Kg
	72 Kg	108 Kg	65 Kg
	860 x 760 x 915(h) mm	1260 x 760 x 915(h) mm	860 x 760 x 915(h) mm
	0,600 m³	0,871 m³	0,595 m³

\* Con sportelli in acciaio inox / With stainless steel doors

Avec portes en acier Inox / Mit Edelstahltüren / Con puertas de acero inoxidable  
С дверями из нержавеющей стали.

Potenza - Power - Puissance - Leistung - Potencia - Мощность

CC74G	CC76G	CC74P
6 kW	6 kW	2,6 kW ø220 mm
3,5 kW	3,5 kW	2,6 kW ø220 mm
3,5 kW	6 kW	2,6 kW ø220 mm
6 kW	3,5 kW	2,6 kW ø220 mm

FR4N  
FR44N

New



FR4N



FR44N

Friggitrici elettriche  
4 L

ELECTRIC FRYERS  
FRITEUSES ÉLECTRIQUES  
ELEKTRISCHE FRITEUSEN  
FREIDORAS ELÉCTRICAS  
ЭЛЕКТРИЧЕСКИЕ ФРИТЮРНИЦЫ

IT Friggitrici da 4 L. Modelli da banco. Struttura, vasca e coperchio in acciaio inox AISI 304 - cestelli a rete estraibili in filo cromato - manici cestelli e pomelli coperchi in plastica termoisolante - resistenze inox - termostato di sicurezza con pulsante di ripristino - versioni a due vasche con doppio termostato per utilizzo indipendente - testata e resistenze removibili - raggiunge i 180°C in circa 10 minuti.







EN Fryers capacity 4 L. Table-top models. Casing, bowl and lid in AISI 304 stainless steel - removable baskets in chrome-plated wire - baskets handles and lids knobs in thermo-insulating material - stainless steel heating elements - safety thermostat with reset button - two-bowls versions with double thermostat for independent use - header and heating element removable - reaches 180°C in about 10 minutes.

FR Friteuses capacité 4 L. Modèles de table. Corps, cuve et couvercle en acier inox AISI 304 - paniers amovibles en fil chromé - poignées et pommeaux des paniers en matériau thermo-isolant - résistance en acier inox - thermostat de sécurité avec bouton de remise à zéro - versions à deux cuves avec double thermostat pour une utilisation indépendante - collecteur et résistances amovibles - atteint 180°C en 10 minutes environ.

DE Friteusen Kapazität 4 L Tischmodelle. Gehäuse, Wanne und Deckel aus Edelstahl AISI 304 - abnehmbare Körbe aus verchromtem Draht - Korbgriffe und Deckelknöpfe aus wärmeisolierendem Material - Heizelemente aus Edelstahl - Sicherheitsthermostat mit Rückstellknopf - Zwei-Wanne - Versionen mit Doppelthermostat für den unabhängigen Gebrauch - Kopfteil und abnehmbare Heizelement - erreicht 180°C in ca. 10 Minuten.

ES Freidoras de 4 L. Modelos de sobremesa. Carcasa, cuba y tapa de acero inoxidable AISI 304 - cestas desmontables de alambre cromado - asas de cestas y tapas de material termoaislante - resistencias de acero inoxidable - termostato de seguridad con pulsador de rearme - versiones de dos cubas con doble termostato de uso independiente - cabezal y resistencias desmontables - alcanzan los 180°C en unos 10 minutos.

RU 4 л фритюрницы. Настольные модели. Корпус, чаша и крышка из нержавеющей стали AISI 304 - съемные корзины из хромированной проволоки - ручки корзин и крышек из термоизоляционного материала - резисторы из нержавеющей стали - предохранительные термостаты. с кнопкой сброса - версии с двумя барабанами и независимым двойным термостатом - головой и съемными нагревательными элементами - достигают 180°C примерно за 10 минут.

	FR4N	FR44N
	2,5 kW	2,5 + 2,5 kW
 1 Ph	230V/1N/50-60Hz	
	50÷180°C	
 Kg/h	4,5 Kg/h	4,5 + 4,5 Kg/h
 L	6 L	6 + 6 L
	min. 3 L / max. 4 L	min. 3 L / max. 4 L cad.
	0,5 Kg	0,5 + 0,5 Kg
 mm	175 x 426/573 x 318(h) mm	384 x 426/573 x 315(h) mm
		
 NET Kg	4,5 Kg	8,5 Kg
 GROSS Kg	5 Kg	9,5 Kg
 mm	250 x 505 x 365(h) mm	426 x 505 x 365(h) mm
 m³	0,045 m³	0,085 m³

# FR8N-FR88N FR8RN-FR88RN

New



FR8N



FR88N



FR8RN



FR88RN

Friggitrici elettriche  
8 L

ELECTRIC FRYERS  
FRITEUSES ÉLECTRIQUES  
ELEKTRISCHE FRITEUSEN  
FREIDORAS ELÉCTRICAS  
ЭЛЕКТРИЧЕСКИЕ ФРИТЮРНИЦЫ



IT Friggitrici da 8 L, modelli da banco. Struttura, vasca e coperchio in acciaio inox AISI 304 - cestelli a rete estraibili in filo cromato - manici cestelli e pomelli coperchi in plastica termoisolante - resistenze inox - termostato di sicurezza con pulsante di ripristino - versioni a due vasche con doppio termostato per utilizzo indipendente - testata e resistenze removibili. I modelli FR8RN e FR88RN sono dotati di rubinetti di sicurezza. Raggiungono i 180°C in circa 18 minuti tempo di frittura in circa 7 minuti.













EN Fryers capacity 8 L Table-top models. Casing, bowl and lid in AISI 304 stainless steel - removable baskets in chrome-plated wire - baskets handles and lids knobs in thermo-insulating material - stainless steel heating elements - safety thermostat with reset button - two-bowls versions with double thermostat for independent use - header and heating element removable. The FR8RN and FR88RN models are equipped with safety valves. They reach 180°C in about 18 minutes frying time about 7 minutes.

FR Friteuses capacité 8 L modèles de table. Corps, cuve et couvercle en acier inox AISI 304 - paniers amovibles en fil chromé - poignées et pommeaux des paniers en matériau thermo-isolant - résistance en acier inox - thermostat de sécurité avec bouton de remise à zéro - versions à deux cuves avec double thermostat pour une utilisation indépendante - collecteur et résistances amovibles. Les modèles FR8RN et FR88RN sont équipés de robinets de sécurité. Ils atteignent 180°C en environ 18 minutes temps de friture de 7 minutes environ.

DE Friteusen Kapazität 8 L Tischmodelle. Gehäuse, Wanne und Deckel aus Edelstahl AISI 304 - abnehmbare Körbe aus verchromtem Draht - Korbgriffe und Deckelknöpfe aus wärmeisolierendem Material - Heizelemente aus Edelstahl - Sicherheitsthermostat mit Rückstellknopf - Zwei-Wanne-Versionen mit Doppelthermostat für den unabhängigen Gebrauch - Kopfteil und abnehmbare Heizelement. Die Modelle FR8RN und FR88RN sind mit Sicherheitsarmaturen ausgestattet. Sie erreichen 180°C in etwa 18 Minuten Frittierzeit von etwa 7 Minuten.

ES Freidoras de 8 L. Modelos de sobremesa. Carcasa, cuba y tapa de acero inoxidable AISI 304 - cestas desmontables de alambre cromado - asas de cestas y tapas de material termoaislante - resistencias de acero inoxidable - termostato de seguridad con pulsador de rearme - versiones de dos cubas con doble termostato de uso independiente - cabezal y resistencias desmontables. Los modelos FR8RN y FR88RN están equipados con grifos de seguridad. Alcanzan los 180°C en unos 18 minutos de frittura en unos 7 minutos.

RU 8 л фритюрницы. Настольные модели. Корпус, чаша и крышка из нержавеющей стали AISI 304 - съемные корзины из хромированной проволоки - ручки корзин и крышек из термоизоляционного материала - резисторы из нержавеющей стали - предохранительные термостаты. с кнопкой сброса - версии с двумя барабанами и независимым двойным термостатом - головой и съемными нагревательными элементами. Модели FR8RN и FR88RN оснащены предохранительными кранами. Они достигают 180°C примерно за 18 минут времени обжарки примерно за 7 минут.

	FR8N	FR8RN	FR88N FR88RN
	3 kW		3 + 3 kW
 1 Ph	230V/1N/50-60Hz		
	50÷180°C		
 Kg/h	8 Kg/h		8 + 8 Kg/h
 L	10 L		10 +10 L
	min. 6 L / max. 8 L		min. 6 L / max. 8 L cad.
	1 Kg		1 + 1 Kg
 mm	265 x 426/578 x 359(h) mm	265 x 470/577 x 359(h) mm	565 x 426/576 x 359(h) mm
			
 NET Kg	7,5 Kg		15 Kg
 GROSS Kg	8 Kg		16,5 Kg
 mm	331 x 505 x 405(h) mm		635 x 505 x 405(h) mm
 m³	0,067 m³		0,124 m³

# FR10RN FR1010RN

New



Friggitrici elettriche  
10 L con rubinetto

ELECTRIC FRYERS  
FRITEUSES ÉLECTRIQUES  
ELEKTRISCHE FRITEUSEN  
FREIDORAS ELÉCTRICAS  
ЭЛЕКТРИЧЕСКИЕ ФРИТЮРНИЦЫ

IT Friggitrici da 10 L. Modelli da banco - dotate di rubinetti di sicurezza. Struttura, vasca e coperchio in acciaio inox AISI 304 - cestelli a rete estraibili in filo cromato - manici cestelli e pomelli coperchi in plastica termoisolante - resistenze inox - termostato di sicurezza con pulsante di ripristino - versioni a due vasche con doppio termostato per utilizzo indipendente - testata e resistenze removibili. Raggiungono i 180° in circa 12 minuti, tempo di frittura in circa 5 minuti.















EN Fryers capacity 10 L Table-top models - equipped with safety valves. Casing, bowl and lid in AISI 304 stainless steel - removable baskets in chrome-plated wire - baskets handles and lids knobs in thermo-insulating material - stainless steel heating elements - safety thermostat with reset button - two-bowls versions with double thermostat for independent use - header and heating element removable . They reach 180°C in about 12 minutes frying time about 5 minutes.

FR Friteuses capacité 10 L modèles de table - équipés de robinets de sécurité. Corps, cuve et couvercle en acier inox AISI 304 - paniers amovibles en fil chromé - poignées et pommeaux des paniers en matériau thermo-isolant - résistance en acier inox - thermostat de sécurité avec bouton de réarmement - versions à deux cuves avec double thermostat pour une utilisation indépendante - collecteur et résistances amovibles. Ils atteignent 180°C en environ 12 minutes temps de friture de 5 minutes environ.

DE Friteusen Kapazität 10 L Tischmodelle - mit Sicherheitsarmaturen ausgestattet. Gehäuse, Wanne und Deckel aus Edelstahl AISI 304 - abnehmbare Körbe aus verchromtem Draht - Korbgriffe und Deckelknöpfe aus wärmeisolierendem Material - Heizelemente aus Edelstahl - Sicherheitsthermostat mit Rückstellknopf - Zwei-Wanne-Versionen mit Doppelthermostat für den unabhängigen Gebrauch - Kopfteil und abnehmbare Heizelement. Sie erreichen 180°C in etwa 12 Minuten Frittierzeit von etwa 5 Minuten.

ES Freidoras de 10 L. Modelos de sobremesa - están equipados con grifos de seguridad. Carcasa, cuba y tapa de acero inoxidable AISI 304 - cestas desmontables de alambre cromado - asas de cestas y tapas de material termoaislante - resistencias de acero inoxidable - termostato de seguridad con pulsador de rearme - versiones de dos cubas con doble termostato de uso independiente - cabezal y resistencias desmontables. Alcanzan los 180°C en unos 12 minutos de frittura en unos 5 minutos.

RU 10 л фритюрницы. Настольные модели - оснащены предохранительными кранами. Корпус, чаша и крышка из нержавеющей стали AISI 304 - съемные корзины из хромированной проволоки - ручки корзин и крышек из термоизоляционного материала - резисторы из нержавеющей стали - предохранительные термостаты с кнопкой сброса - версии с двумя барабанами и независимым двойным термостатом - головкой и съемными нагревательными элементами. Они достигают 180°C примерно за 12 минут времени обжарки примерно за 5 минут.

	FR10RN	FR1010RN
	6 kW	6 + 6 kW
	400V/3N/50-60Hz	
	50±180°C	
	11 Kg/h	11 + 11 Kg/h
	12 L	12 + 12 L
	min. 8 L / max. 10 L	min. 8 L / max. 10 L cad.
	1,25 Kg	1,25 + 1,25 Kg
	265 x 519/623 x 359(h) mm	564 x 519/626 x 359(h) mm
		
	8,5 Kg	17 Kg
	10 Kg	19 Kg
	561 x 338 x 405(h) mm	630 x 557 x 410(h) mm
	0,75 m³	0,172 m³

# SFM18 SFM18D



SFM18



SFM18D

Friggitrici elettriche  
18 L

ELECTRIC FRYERS  
FRITEUSES ÉLECTRIQUES  
ELEKTRISCHE FRITEUSEN  
FREIDORAS ELÉCTRICAS  
ЭЛЕКТРИЧЕСКИЕ ФРИТЮРНИЦЫ

IT Friggitrici da 18 L. Dotate di mobile - struttura, vasche, coperchi, cestelli e resistenze in acciaio inox AISI 304 - manici cestelli e pomelli coperchi in materiale isolante - termostato di sicurezza con pulsante di ripristino - dotate di un cestello grande - rubinetto scarico e bacinella raccogli olio con filtro e beccuccio in acciaio inox - resistenze ribaltabili - reti protezione in vasca. Il modello SFM18D ha due vasche con doppio termostato per utilizzo indipendente. Raggiungono i 190°C in circa 6 minuti, tempo di frittura in circa 5 minuti.















EN 18 L fryer. On neutral element - casing, bowls, lids, baskets and resistances in stainless steel AISI 304 - basket handles and knobs in insulating material - safety thermostat with reset button - equipped with a large basket - drain valve and oil collecting basin with stainless steel filter and nozzle - tilting heating elements - protection nets in the bowl. The model SFM18D has two bowls with double thermostat for independent use. It reaches 190°C in about 6 minutes, frying time in about 5 minutes.

FR Friteuses capacité 18 L Sur meuble neutre -corps, cuve, couvercle, paniers et résistances en acier inox AISI 304 - poignées et pommeaux des paniers en matériau thermo-isolant - thermostat de sécurité avec bouton de réarmement équipé d'un grand panier - vanne de vidange et bac collecteur d'huile avec filtre et buse en acier inoxydable - Résistances basculantes - grilles de protection dans la cuve. Le modèle SFM18D dispose de deux cuves avec double thermostat pour une utilisation indépendante. Ils atteignent 190°C en environ 6 minutes temps de friture de 5 minutes environ.

DE Friteusen Kapazität 18 L Auf neutral Element -Gehäuse, Wanne, Deckel, Körbe und Heizkörper aus Edelstahl AISI 304 - Korbgriffe und Deckelknöpfe aus wärmeisulierendem Material - Sicherheitsthermostat mit Resetknopf - ausgestattet mit einem großen Korb - Ablasshahn und Ölwanne mit Filter und Düse aus Edelstahl - Kippheizelement - Schutznetze im Becken. Das Modell SFM18D verfügt über zwei Becken mit Doppelthermostat für den unabhängigen Einsatz. Erreicht 190°C in etwa 6 Minuten Frittierzeit von etwa 5 Minuten.

ES Freidora de 18 litros. Equipado con armario - estructura, depósitos, tapas, cestas y resistencias en acero inoxidable AISI 304 - asas y pomos tapas en material aislante - termostato de seguridad con pulsador de rearme - equipado con una gran cesta - grifo de vaciado y bandeja de aceite con filtro y boquilla en acero inoxidable - resistencias basculantes - redes de protección en el depósito. El modelo SFM18D dispone de dos depósitos con doble termostato para uso independiente. Alcanzando 190°C en unos 6 minutos, tiempo de freír en unos 5 minutos.

RU 18-литровая жаровня для жарки во фритюре. Оснащен шкафом - конструкция, баки, крышки, корзины и сопротивления из нержавеющей стали AISI 304 - ручки и ручки крышки из изоляционного материала - предохранительный термостат с кнопкой сброса - оснащен большой корзиной - сливной кран и масляный поддон с фильтром и соплом из нержавеющей стали - сопротивление опрокидыванию - защитные сетки в баке. Модель SFM18D имеет два бака с двойным термостатом для самостоятельного использования. Температура достигает 190°C примерно за 6 минут, время обжарки - примерно за 5 минуты.

	SFM18	SFM18D
	11,5 kW	11,5 + 11,5 kW
	400V/3N/50-60Hz	
	50÷195°C	
	30 Kg/h	60 Kg/h
	22 L	22 + 22 L
	18 L	18 + 18 L
	2,5 Kg	2,5 + 2,5 Kg
	400 x 700 x 978(h) mm	800 x 700 x 978(h) mm
		
	40 Kg	72 Kg
	51 Kg	85 Kg
	470 x 800 x 1210(h) mm	870 x 800 x 1210(h) mm
	0,455 m³	0,842 m³

# SF25P



## Friggitrici elettriche 25 L per pasticceria

ELECTRIC FRYERS  
FRITEUSES ÉLECTRIQUES  
ELEKTRISCHE FRITEUSEN  
FREIDORAS ELÉCTRICAS  
ЭЛЕКТРИЧЕСКИЕ ФРИТЮРНИЦЫ

IT Friggitrice da 25 L per pasticceria. Modello da banco - struttura, vasca, coperchio, cestello e resistenze in acciaio inox AISI 304 - manici cestelli e pomelli coperchi in materiale isolante - termostato di sicurezza con pulsante di ripristino - testata e resistenze removibili - rubinetto di sicurezza esterno con sistema di scarico a innesto frontale a baionetta - dotata di un cestello grande. Raggiunge i 180°C in circa 16 minuti, tempo di frittura in circa 6 minuti.















EN 25 L fryer for pastry. Counter-top model - casing, tank, lid, basket and heating elements in stainless steel AISI 304 - basket handles and knobs in insulating material - safety thermostat with reset button - removable head and heating elements - external safety tap with bayonet frontal plug-in discharge system - equipped with a large basket. It reaches 180°C in about 16 minutes, frying time in about 6 minutes.

FR Friteuse de 25 L pour pâtisserie. Modèle de comptoir - corps, cuve, couvercle, panier et éléments chauffants en acier inox AISI 304 - poignées et boutons en matériau isolant - thermostat de sécurité avec bouton de réinitialisation - tête et éléments chauffants amovibles - robinet de sécurité externe avec système de déchargement frontal à baïonnette - équipé d'un grand panier. Il atteint 180°C en 16 minutes environ, le temps de friture en 6 minutes environ.

DE 25 L Fritteuse für Konditorei. Tischmodell - Gehäuse, Tank, Deckel, Korb und Heizelemente aus Edelstahl AISI 304 - Korbgriffe und - knöpfe aus Isolierstoff - Sicherheitsthermostat mit Rückstellknopf - abnehmbarer Kopf und Heizelemente - externer Sicherheitshahn mit Bajonett-Stecksystem - ausgestattet mit einem großen Korb. Erreicht 180°C in ca. 16 Minuten, Frittierzeit ca. 6 Minuten.

ES Freidora de 25 litros para pastelería. Modelo de mostrador - carcasa, depósito, tapa, cesta y elementos calefactores en acero inoxidable AISI 304 - manijas y pomos de cesta en material aislante - termostato de seguridad con pulsador de rearme - cabezal y elementos calefactores extraíbles - grifo de seguridad externo con sistema de descarga frontal de bayoneta - equipado con una cesta grande. Alcanza los 180°C en unos 16 minutos y se fríe en unos 6 minutos.

RU Фритюрница на 25 литров для выпечки кондитерских изделий. Модель столешницы - корпус, бак, крышка, корзина и нагревательные элементы из нержавеющей стали AISI 304 - ручки и ручки корзины из изоляционного материала - предохранительный термостат с кнопкой сброса - съемная головка и нагревательные элементы - внешний предохранительный кран с байонетным передним сливом - оснащен большой корзиной. Температура достигает 180°C примерно за 16 минут, время обжарки - около 6 минут.

	<b>SF25P</b>
	9 kW
	400V/3N/50-60Hz
	50÷180°C
	45 Kg/h
	29 L
	25 L
	7 Kg
	585 x 660 x 440(h) mm
	
	22,5 Kg
	26 Kg
	660 x 730 x 480(h) mm
	0,231 m³

SF10M  
SF10DM



SF10M



SF10DM

Friggitrici a gas  
10 L

GAS FRYERS  
FRITEUSES À GAZ  
GAS FRITEUSEN  
FREIDORAS A GAS  
ГАЗОВЫЕ ФРИТЮРНИЦЫ



IT Friggitrici a gas da 10 L. Struttura, coperchi, cestelli e resistenze in acciaio inox AISI 304 - piano di lavoro e vasche stampate in acciaio inox spessore 15/10 - manici, cestelli, pomelli e coperchi in materiale isolante - allacciamento gas 1/2"G - termostato a 7 posizioni da 110÷190°C - bruciatori inox tubolari con sistema turbolatore che rallenta il flusso della fiamma aumentandone la resa di circa il 50%, combustione ottimizzata con valvola termocoppia e termostato di sicurezza - fiamma pilota protetta - accensione con piezoelettrico - alimentazione a metano, in dotazione kit GPL - rubinetto scarico - dotate di un cestello grande - modelli da banco. Raggiungono i 190°C in circa 10 minuti. Modello SF10DM con due vasche e doppio termostato per utilizzo indipendente.

















EN Gas fryers 10 L - Structure, lids, baskets and heating elements in stainless steel AISI 304 - moulded worktop and bowls in stainless steel thickness 15/10 - basket handles and knobs with insulating material - 1/2"G gas connection - 7 position thermostat 110÷190°C - stainless steel tubular burners with turbulator system that slows down the flow of the flame increasing the yield by about 50%, combustion optimized with safety thermocouple and thermostat - protected pilot flame - ignition with piezoelectric - natural gas supply, supplied with LPG kit - drain tap - equipped with a large basket. It reaches 190°C in about 10 minutes. Model SF10DM with two bowls and double thermostat for independent use.

FR Friteuses à gaz 10 L. Corps, couvercles, paniers et éléments chauffants en acier inox AISI 304 - plan de travail et cuves moulées en acier inox épaisseur 15/10 - poignées et boutons de panier en matériau isolant - raccord gaz 1/2"G - thermostat 7 positions de 110÷190°C - brûleurs tubulaires en acier inox avec système turbulateur qui ralentit le flux de la flamme en augmentant son rendement de 50% environ, allumage avec thermoouple et thermostat de sécurité - flamme pilote protégée - allumage à piézoélectrique - livrée à gaz naturel avec kit LPG - robinet de vidange - grand panier équipé avec un thermostat. Elle atteint 190°C en 10 minutes environ. Modèle SF10DM avec deux cuves avec double thermostat pour une utilisation indépendante.

DE Gas-Fritteusen 10 L. Gehäuse, Deckel, Körbe und Heizelemente aus Edelstahl AISI 304 - Arbeitsplatte und geformte Wannen aus Edelstahl 15/10 - Korbgriffe und -knöpfe mit Isoliermaterial - 1/2"G Gasanschluss - 7-stufiger Thermostat 110÷190°C - Edelstahlrohrbrenner mit Turbulatorsystem, das den Flammenfluss verlangsamt und die Ausbeute um ca. 50% erhöht, Verbrennung optimiert mit Sicherheitsthermoelement und Thermostat - geschützte Pilotflamme - Zündung mit Piezo - Erdgasversorgung, geliefert mit LPG-Kit - Ablasshahn - ausgestattet mit einem großen Korb. Erreicht 190°C in ca. 10 Minuten. Das Modell SF10DM verfügt über zwei Wannen mit Doppelthermostat für den unabhängigen Einsatz.

ES Freidoras a gas 10 L. Estructura, tapas, cestas y elementos calefactores en acero inoxidable AISI 304 - encimera y depósitos moldeados en acero inoxidable espesor 15/10 - asas y pomos de cesta con material aislante - conexión a gas 1/2"G - termostato de 7 posiciones de 110÷190°C - quemadores tubulares en acero inoxidable con sistema de turbulador que ralentiza el flujo de la llama aumentando el rendimiento en un 50% aproximadamente, combustión optimizada con termopar de seguridad y termostato - llama piloto protegida - llama piloto - ignición piezoeléctrica - alimentación de gas natural - con kit de GPL - llave de desagüe - provisto de un amplio recipiente de drenaje. Alcanza los 190°C en unos 10 minutos. Modelo SF10DM con dos bols con doble termostato para uso independiente.

RU Газовые фритюрницы 10 литров. Конструкция, крышки, корзины и нагревательные элементы из нержавеющей стали AISI 304 - столешница и формованные баки из нержавеющей стали толщиной 15/10 - ручки и ручки с изоляционным материалом - подключение газа 1/2"G - 7-позиционный термостат от 110 до 190°C - трубчатые горелки из нержавеющей стали с турбулизатором, замедляющим поток пламени, увеличивающим выход примерно на 50%, сжигание, оптимизированное с помощью предохранительной термопары - газовый клапан P, защищенный на 50°C - электростатими. Температура достигает 190°C примерно за 10 минут. Модель SF10DM имеет два бака с двойным термостатом для самостоятельного использования.

	SF10M	SF10DM
	6,9 kW	6,9 + 6,9 kW
	5934 kcal/h 23543 BTU/h	5934 + 5934 kcal/h 23543 + 23543 BTU/h
	G20 = 0,73 m³/h G25 = 0,85 m³/h	G20 = 0,73 + 0,73 m³/h G25 = 0,85 + 0,85 m³/h
	G30/G31 = 0,53 Kg/h	G30/G31 = 0,53 + 0,53 Kg/h
	N° 2 (Bruciatori - Burners - Горелки)	N° 2 + 2 (Bruciatori - Burners - Горелки)
	12 Kg/h	12 + 12 Kg/h
	13 L	13 + 13 L
	10 L	10 + 10 L
	1 Kg	1 + 1 Kg
	400 x 700 x 370(h) mm	800 x 700 x 370(h) mm
		
	24 Kg	41 Kg
	31 Kg	55 Kg
	480 x 780 x 600(h) mm	880 x 800 x 600(h) mm
	0,225 m³	0,423 m³

# SFM20M SFM20DM



SFM20M



SFM20DM

Friggitrici a gas  
20 L

GAS FRYERS  
FRITEUSES À GAZ  
GAS FRITEUSEN  
FREIDORAS A GAS  
ГАЗОВЫЕ ФРИТЮРНИЦЫ

**IT** Friggitrici a gas da 20 L. Struttura, coperchi, cestelli e resistenze in acciaio inox AISI 304 - piano di lavoro e vasche stampate in acciaio inox spessore 15/10 - manici, cestelli, pomelli e coperchi in materiale isolante - allacciamento gas 1/2"G - termostato a 7 posizioni da 110÷190°C - bruciatori inox tubolari con sistema turbolatore che rallenta il flusso della fiamma aumentandone la resa di circa il 50%, combustione ottimizzata con valvola termocoppia e termostato di sicurezza - fiamma pilota protetta - accensione con piezoelettrico - alimentazione a metano, in dotazione kit GPL - rubinetto scarico - dotate di un cestello grande - modelli da banco. Raggiungono i 190°C in circa 10 minuti. Modello SFM20DM con due vasche e doppio termostato per utilizzo indipendente.













**EN** Gas fryers 20 L - Structure, lids, baskets and heating elements in stainless steel AISI 304 - moulded worktop and bowls in stainless steel thickness 15/10 - basket handles and knobs with insulating material - 1/2"G gas connection - 7 position thermostat 110÷190°C - stainless steel tubular burners with turbulator system that slows down the flow of the flame increasing the yield by about 50%, combustion optimized with safety thermocouple and thermostat - protected pilot flame - ignition with piezoelectric - natural gas supply, supplied with LPG kit - drain tap - equipped with a large basket. It reaches 190°C in about 10 minutes. Model SFM10DM with two bowls and double thermostat for independent use.

**FR** Friteuses à gaz 20 L. Corps, couvercles, paniers et éléments chauffants en acier inox AISI 304 - plan de travail et cuves moulées en acier inox épaisseur 15/10 - poignées et boutons de panier en matériau isolant - raccord gaz 1/2"G - thermostat 7 positions de 110÷190°C - brûleurs tubulaires en acier inox avec système turbulateur qui ralentit le flux de la flamme en augmentant son rendement de 50% environ, allumage avec thermoouple et thermostat de sécurité - flamme pilote protégée - allumage à piézoélectrique - livrée à gaz naturel avec kit LPG - robinet de vidange - grand panier équipé avec un thermostat. Elle atteint 190°C en 10 minutes environ. Modèle SFM10DM avec deux cuves avec double thermostat pour une utilisation indépendante..

**DE** Gas-Fritteusen 20 L. Gehäuse, Deckel, Körbe und Heizelemente aus Edelstahl AISI 304 - Arbeitsplatte und geformte Wannen aus Edelstahl 15/10 - Korbgriffe und -knöpfe mit Isoliermaterial - 1/2"G Gasanschluss - 7- stufiger Thermostat 110÷190°C - Edelstahlrohrbrenner mit Turbulatorsystem, das den Flammenfluss verlangsamt und die Ausbeute um ca. 50% erhöht, Verbrennung optimiert mit Sicherheitsthermoelement und Thermostat - geschützte Pilotflamme - Zündung mit Piezo - Erdgasversorgung, geliefert mit LPG-Kit - Ablasshahn - ausgestattet mit einem großen Korb. Erreicht 190°C in ca. 10 Minuten. Das Modell SFM10DM verfügt über zwei Wannen mit Doppelthermostat für den unabhängigen Einsatz.

**ES** Freidoras a gas 20 L. Estructura, tapas, cestas y elementos calefactores en acero inoxidable AISI 304 - encimera y depósitos moldeados en acero inoxidable espesor 15/10 - asas y pomos de cesta con material aislante - conexión a gas 1/2"G - termostato de 7 posiciones de 110÷190°C - quemadores tubulares en acero inoxidable con sistema de turbulador que ralentiza el flujo de la llama aumentando el rendimiento en un 50% aproximadamente, combustión optimizada con termopar de seguridad y termostato - llama piloto protegida - llama piloto - ignición piezoeléctrica - alimentación de gas natural - con kit de GPL - llave de desagüe - provisto de un amplio recipiente de drenaje. Alcanza los 190°C en unos 10 minutos. Modelo SFM10DM con dos bols con doble termostato para uso independiente.

**RU** Газовые фритюрницы 20 литров. Конструкция, крышки, корзины и нагревательные элементы из нержавеющей стали AISI 304 - столешница и формованные баки из нержавеющей стали толщиной 15/10 - ручки и ручки с изоляционным материалом - подключение газа 1/2"G - 7-позиционный термостат от 110 до 190°C - трубчатые горелки из нержавеющей стали с турбулизатором, замедляющим поток пламени, увеличивающим выход примерно на 50%, сжигание, оптимизированное с помощью предохранительной термопары - газовый клапан P, защищенный на 50°C - электростатими. Температура достигает 190°C примерно за 10 минут. Модель SFM10DM имеет два бака с двойным термостатом для самостоятельного использования.

	<b>SFM20M</b>	<b>SFM20DM</b>
	16,5 kW	16,5 + 16,5 kW
<b>kcal/h BTU/h</b>	14190 kcal/h 56300 BTU/h	14190 + 14190 kcal/h 56300 + 56300 BTU/h
<b>METANO METHANE METAHA</b>	G20 = 1,75 m³/h G25 = 2,03 m³/h	G20 = 1,75 + 1,75 m³/h G25 = 2,03 + 2,03 m³/h
<b>GPL LPG</b>	G30/G31 = 1,29 Kg/h	G30/G31 = 1,29 + 1,29 Kg/h
	N° 3 (Bruciatori - Burners - Горелки)	N° 3 + 3 (Bruciatori - Burners - Горелки)
	25 Kg/h	25 + 25 Kg/h
	24 L	24 + 24 L
	20 L	20 + 20 L
	2,5 Kg	2,5 + 2,5 Kg
	400 x 700 x 980(h) mm	800 x 700 x 980(h) mm
		
	47 Kg	83 Kg
	57 Kg	98 Kg
	480 x 780 x 1200(h) mm	880 x 800 x 1200(h) mm
	0,449 m³	0,845 m³



FR88RN



SFM20M



FR8N

Optional  
friggitrici elettriche e gas

ACCESSORIES  
ACCESSOIRES  
ZUBEHÖR  
ACCESORIOS  
AKCECCYAPЫ

	Friggitrici elettriche - Electric fryers - Friteuses electriques Elektrofritteusen - Freidoras eléctricas - Электрические фритюрницы						Friggitrici a gas - Gas fryers - Friteuses a gaz Gasfritteusen - Freidoras a gas Газовые фритюрницы			
Mod.	FR4N FR44N	FR8N FR88N FR8RN FR88RN	FR10RN FR1010RN	SFM18 SFM18D	SFM18 SFM18D	SF25P	SF10 SF10DM	SF10M SF10DM	SFM20M SFM20DM	SFM20M SFM20DM
				standard 1 cesto 1 basket	optional 2 mezzi cesti 2 half baskets	standard 1 cesto 1 basket	standard 1 cesto 1 basket	optional 2 mezzi cesti 2 half baskets	standard 1 cesto 1 basket	optional 2 mezzi cesti 2 half baskets
A	415 mm	430 mm	455 mm	545 mm		-	550 mm		545 mm	
B	235 mm	250 mm	275 mm	315 mm		480 mm	300 mm		360 mm	
C	180 mm			210 mm		55x2 mm	190 mm		180 mm	
D	135 mm	210 mm		270 mm	124 mm	450 mm	245 mm	110 mm	280 mm	135 mm
E	100 mm	110 mm		115 mm		125 mm	115 mm		150 mm	
F	200 mm			255 mm		265 mm	210 mm		220 mm	
G	320 mm		370 mm	-						
H	200 mm	210 mm		215 mm		-	210 mm		250 mm	
I	299 mm		348 mm	400 mm		-	345 mm		405 mm	
L	170 mm	260 mm								
M	149 mm	238 mm		300 mm		-	260 mm		300 mm	

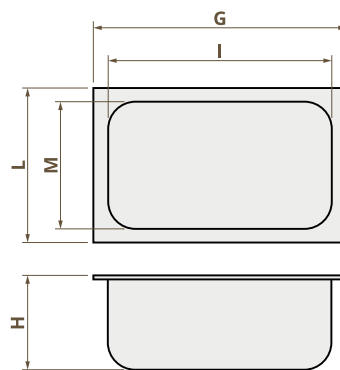
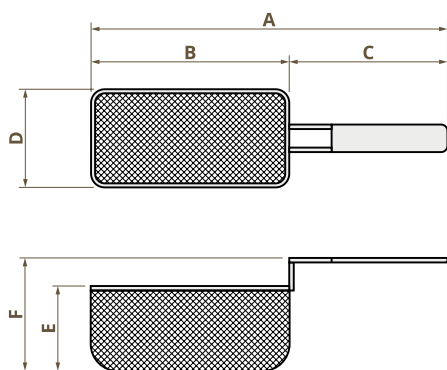

	1 mezzo cesto - 1 half basket 1 demi panier - 1 halber Korb 1 cesta pequeña - 1 полу-корзина	
Mod.	ACSFM10 SF10M SF10DM	ACMCSFM20M SFM20M - SFM20DM SFM18 - SFM18D

SFM18

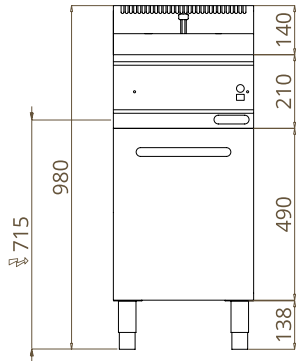

SFM18D

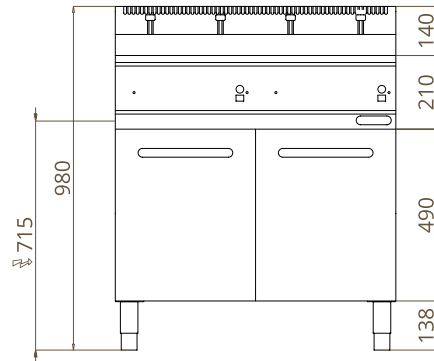

SF25P

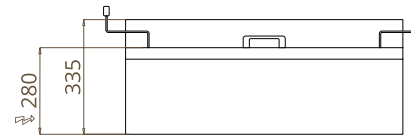

SF10M

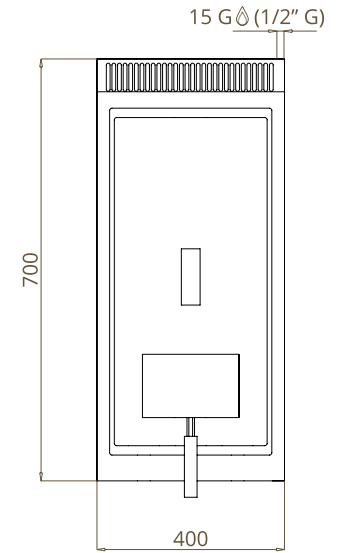
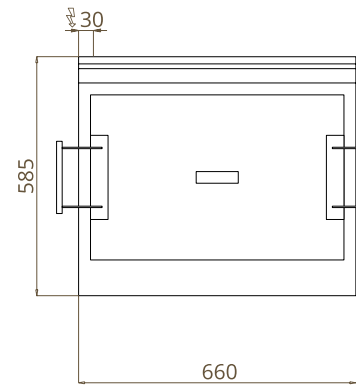
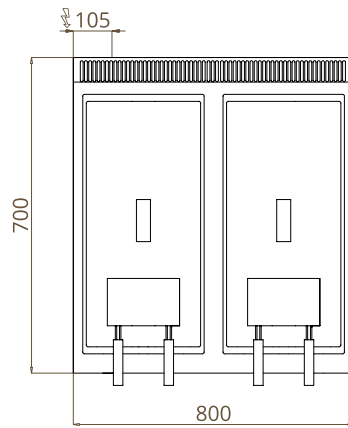
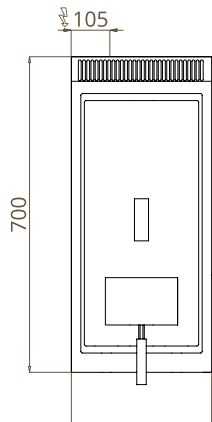
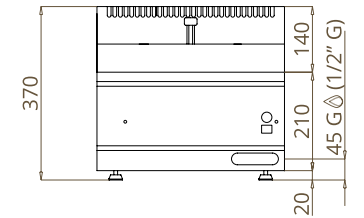

Friggitrici a gas - Gas fryers - Griteuses a gaz - Gasfritteusen - Freidoras a gas - Газовые фритюрницы

SF10DM

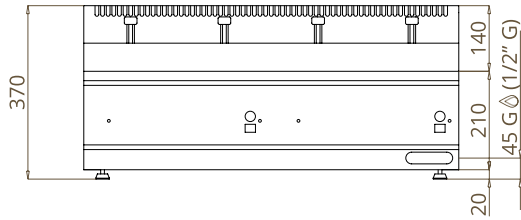

SFM20M

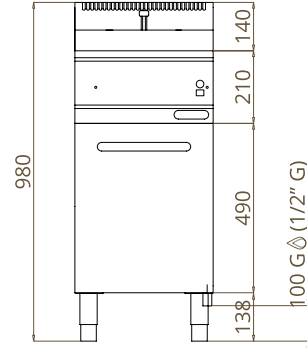

SFM20DM

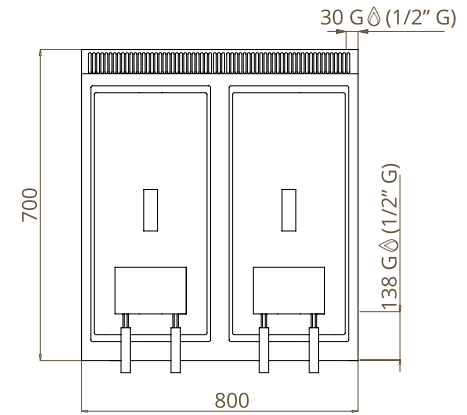
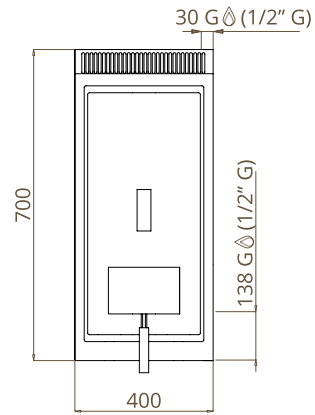
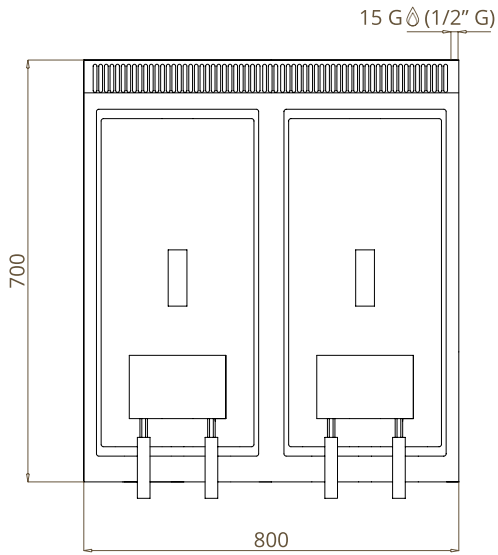
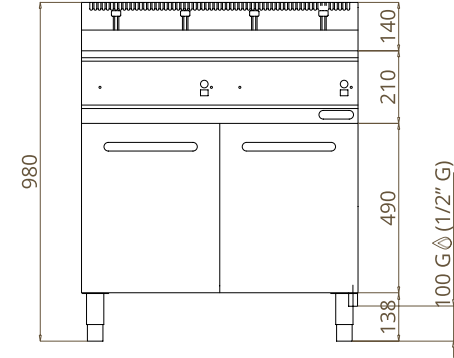

FR4N

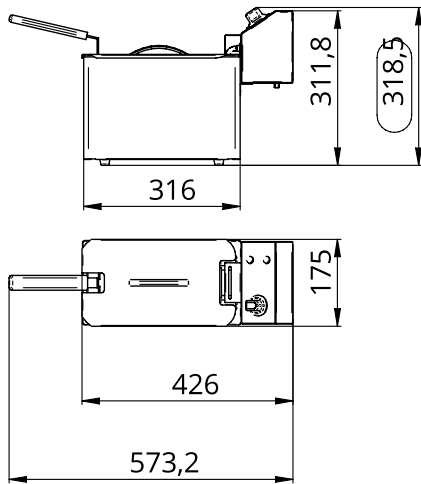

FR44N

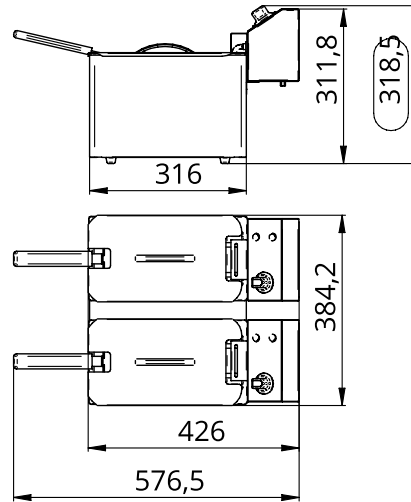

FR8N

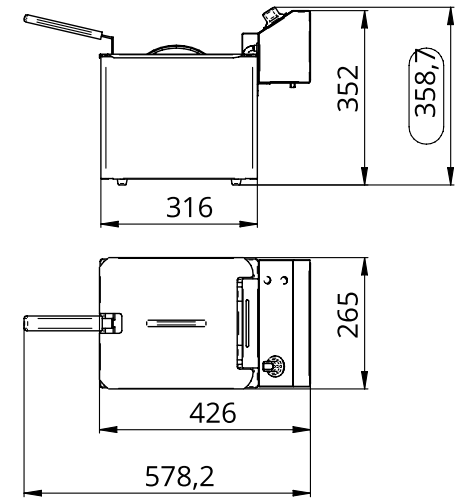

FR8RN

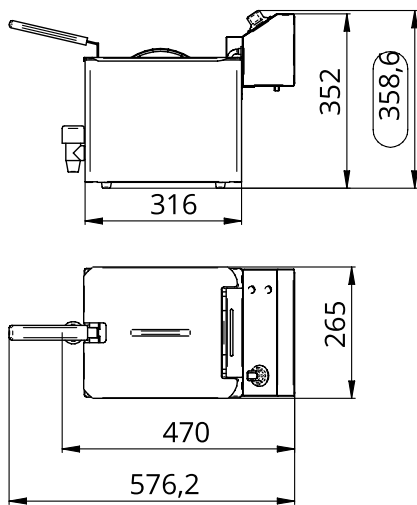

FR88RN

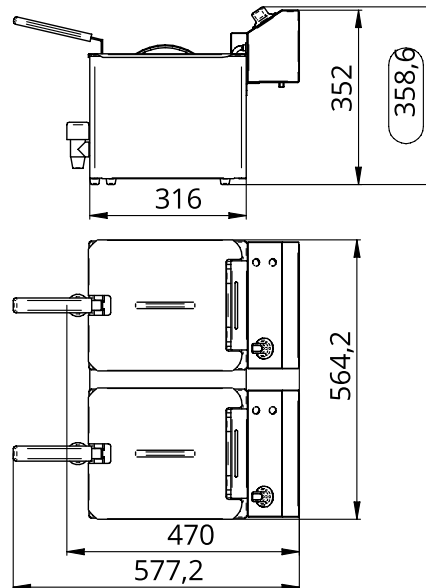

FR10RN

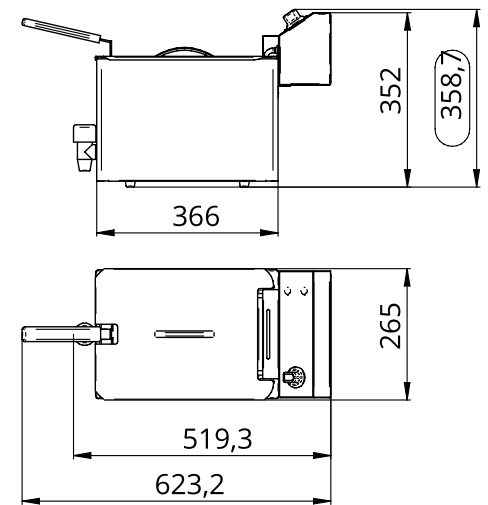



FR88N

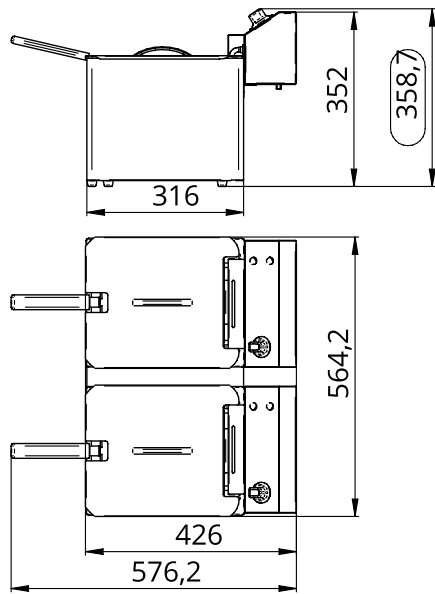

FR1010RN

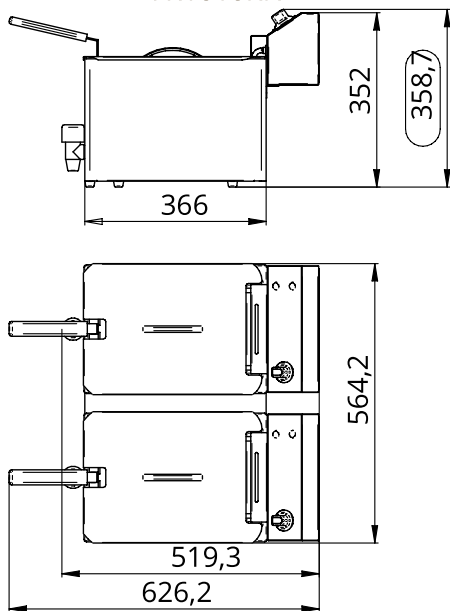

# CP11N CPM30



CPM30



CP11N

## Cuocipasta elettrici

ELECTRIC PASTA COOKERS  
CUISEURS À PÂTE ÉLECTRIQUES  
ELEKTRO NUDELKOCHER  
COCEDORES DE PASTA ELÉCTRICOS  
ЭЛЕКТРИЧЕСКИЕ МАКАРОНОВАРКИ

**IT** Cuocipasta elettrici. Struttura e cestelli in acciaio inox - vasca in acciaio inox AISI 316 spessore 15/10 - manici cestelli in materiale isolante - resistenze corazzate in acciaio inox incoloy - rubinetto carico acqua collegabile alla rete - rubinetto di sicurezza esterno - camino rialzato con funzione paraspruzzi. Il modello CPM30 è dotato di mobile, ha sistema di scarico collegato alla rete e sistema a sfioramento per eliminare i residui di deposito di amido della pasta. Il modello CP11N è da banco, dotato di sistema di scarico a innesto frontale a baionetta e coppia di cestelli piccoli.

**EN** Electric pasta cooker. Casing and baskets in stainless steel - bowl in stainless steel AISI 316 thickness 15/10 - basket handles in insulating material - armored heating elements in stainless steel incoloy - water loading tap connectable to the network - external safety valve - raised chimney with backsplash function. The CPM30 model is equipped with neutral element, a drainage system connected to the network and a touch system to remove pasta starch deposits - the mod. CP11N is a counter model and comes with a frontal bayonet coupling drain system and pair of small containers.

**FR** Cuisseur de pâtes électrique. Corps et paniers en acier inox - cuve en acier inox AISI 316 épaisseur 15/10 - poignées en matériau isolant - éléments chauffants renforcés en acier inox incoloy - robinet de chargement d'eau raccordable au réseau - soupape de sécurité externe - cheminée haute avec fonction de dosseret. Le modèle CPM30 est équipé d'un élément neutre, d'un système de drainage relié au réseau et d'un système tactile pour éliminer les dépôts d'amidon des pâtes - le mod. CP11N est un modèle de comptoir et est muni de système de vidange à amorce frontale à baionnette et paire de petits paniers.

**DE** Elektrischer Nudelkocher. Gehäuse und Körbe aus Edelstahl - Wanne aus Edelstahl AISI 316 Schichtdicke 15/10 - Korbgriffe aus Isoliermaterial - verstärkte Heizelemente aus Edelstahl incoloy - Wasserladeventil netzwerkfähig - externes Sicherheitsventil - erhöhter Kamin mit Aufkantung. Das Mod CPM30 ist mit einem neutralen Element, einem an das Netzwerk angeschlossenen Drainagesystem und einem Touch-System zum Entfernen von Pastastärkeablagerungen ausgestattet. - das Mod. CP11N ist für einen Tresen vorgesehen und ist mit einem Ablasssystem mit Frontal-Bajonettverschluss ausgestattet und ein paar kleiner Körbe.

**ES** Cocedor de pasta eléctrico. Carcasa y cestas de acero inoxidable - cuba de acero inoxidable AISI 316 espesor 15/10 - mangos de cesta de material aislante - elementos calefactores reforzados de acero inoxidable - grifo de carga de agua conectable a la red - válvula de seguridad externa - chimenea elevada con función backsplash. El modelo CPM30 está equipado con un elemento neutro, un sistema de drenaje conectado a la red y un sistema táctil para eliminar los depósitos de almidón de la pasta -el mod. CP11N es para banco y posee un sistema de descarga con acople frontal tipo bayoneta y par de cestos pequeños.

**RU** Электрическая плита для приготовления макарон. Корпус и корзины из нержавеющей стали - чаша из нержавеющей стали толщиной 15/10 AISI 316 - ручки корзины из изоляционного материала - бронированные нагревательные элементы из нержавеющей стали инколой - кран подачи воды, подключаемый к сети - внешний клапан безопасности - поднятая дымоход с функцией защиты от брызг. Модель CPM30 оснащена нейтральным элементом, дренажной системой, подключенной к сети, и сенсорной системой для удаления отложений крахмала макарон. - мод. CP 11N в настольном исполнении и оснащена системой выпуска с фронтальным байонетным соединением и две малых корзины -

	CP11N	CPM30
	3,5 kW	8 kW
	-	400V/3N/50-60Hz
	230V/1N/50-60Hz	-
	20÷100°C ~20'	20÷100°C ~30'
	7 Kg/h	15 Kg/h
	10 L	30 L
	1 Kg	3 Kg
	330 x 600 x 380(h) mm	400 x 700 x 1040(h) mm
		
	16,5 Kg	49 Kg
	18 Kg	59 Kg
	710 x 390 x 410(h) mm	480 x 780 x 1200(h) mm
	0,113 m³	0,449 m³

# CPM30M CPM30DM



CPM30M



CPM30DM

Cuocipasta  
a gas

GAS PASTA COOKERS  
CUISEURS À PÂTE À GAZ  
GAS NUDELKOCHER  
COCEDORES DE PASTA DE GAS  
ГАЗОВЫЕ МАКАРОНОВАРКИ

IT Struttura e cestelli in acciaio inox - vasche in acciaio inox AISI 316 spessore 15/10 trattate con speciale sabbiatura a microsferi in ceramica - sistema a sfioramento per eliminare i residui di deposito di amido della pasta - manici cestelli e pomelli coperchi in materiale isolante - pratico rubinetto carico acqua collegabile alla rete posto sul cruscotto - camino rialzato con funzione paraspruzzi - bruciatori in acciaio inox a alto rendimento, con combustione ottimizzata, posti sotto la vasca, dotati di valvola di sicurezza e termocoppia - accensione con piezoelettrico e fiamma pilota - regolazione di potenza indipendente per ogni vasca - alimentazione a metano, in dotazione kit GPL - dotato di falso fondo appoggio cestelli e mobile.

















EN Stainless steel casing and baskets - AISI 316 stainless steel bowls, thickness 15/10, sandblasted with special ceramic microspheres - touch system to remove pasta starch deposits - basket handles and knobs made of insulating material - handy water filling tap that can be connected to the main network on the front panel - raised chimney with backplash function - high-performance stainless steel burners, with optimized combustion, placed under the bowl, equipped with safety valve and thermocouple - ignition with piezoelectric and pilot flame - independent power regulation for each bowl - natural gas ready, supplied with LPG kit - with false bottom for baskets support on a neutral element.

FR Corps et paniers en acier inoxydable - Cuves en acier inoxydable AISI 316, épaisseur 15/10, sablées avec microsphères spéciales en céramique - système tactile pour éliminer les dépôts d'amidon de pâtes - poignées et boutons en matériau isolant - robinet de remplissage d'eau pratique pouvant être connecté au réseau principal sur le panneau avant - cheminée haute avec fonction de dossier - brûleurs en inox haute performance, à combustion optimisée, placé sous la cuve, équipé d'une soupape de sécurité et d'un thermocouple - allumage avec flamme piézoélectrique et veilleuse - régulation indépendante de la puissance pour chaque cuve - prêt pour le gaz naturel, fourni avec kit GPL - avec faux fond pour le support des paniers sur un élément neutre.

DE Gehäuse und Körbe aus Edelstahl - Wannen aus Edelstahl AISI 316, Dicke 15/10, sandgestrahlt mit speziellen keramischen Mikrokugeln - Touch-System zum Entfernen von Nudelstärkeablagerungen - Korbgriffe und -knöpfe aus Isoliermaterial - praktischer Wasserfüllhahn, der an das Hauptnetz auf der Vorderseite angeschlossen werden kann - erhöhter Schornstein mit Aufkantungsfunktion - Hochleistungs-Edelstahlbrenner, mit optimierter Verbrennung, unter der Wanne angebracht, mit Sicherheitsventil und Thermoelement ausgestattet - Zündung mit piezoelektrischer und Pilotflamme - unabhängige Leistungsregelung für jede Wanne - erdgasbereit, geliefert mit LPG-Kit - mit Doppelboden für Korbablage auf einem neutralen Element.

ES Carcasa y cestas de acero inoxidable - cubas de acero inoxidable AISI 316, espesor 15/10, tratadas con chorro de arena con microsferas de cerámica especial - sistema táctil para eliminar los depósitos de almidón de la pasta - manijas de las cestas y pomos de material aislante - práctico grifo de llenado de agua que puede conectarse a la red principal a través del panel frontal - chimenea levantada con función de rebaba de salpicaduras - quemador de acero inoxidable de alto rendimiento, con combustión optimizada, colocado debajo de la cuba, equipado con válvula de seguridad y termopar - encendido con llama piezoeléctrica y piloto - regulación de potencia independiente para cada cuba - preparado para gas natural, suministrado con kit GLP - con falso fondo para el apoyo de las cestas sobre un elemento neutro.

RU Корпус и корзины из нержавеющей стали - Чашки из нержавеющей стали AISI 316, толщина 15/10, пескоструйная обработка специальными керамическими микросферами - сенсорная система для удаления отложений крахмала макарон - ручки и ручки из изоляционного материала - удобный кран для наполнения водой, который можно подключить к основной сети на лицевой панели - поднятая труба с функцией обратного рассеяния - высокоэффективные конфорки из нержавеющей стали, с оптимизированным сжиганием, помещенный под чашу, оснащенный предохранительным клапаном и термопарой - зажигание с пьезоэлектрическим и пилотным пламенем - независимое регулирование мощности для каждой чашки - готовый природный газ, поставляется с комплектом для подключения сжиженного газа - с двойным дном для поддержки корзин на нейтральном элементе.

	CPM30M	CPM30DM
	10 kW	10 kW + 10 kW
	8600 kcal/h - 34120 BTU/h	8600 + 8600 kcal/h 34120 + 34120 BTU/h
	G20 = 1,05 m³/h G25 = 1,23 m³/h	G20 = 1,05 + 1,05 m³/h G25 = 1,23 + 1,23 m³/h
	G30/G31 = 0,78 Kg/h	G30/G31 = 0,78 + 0,78 Kg/h
	N° 1 (Bruciatori - Burners - Горелки)	N° 2 (Bruciatori - Burners - Горелки)
	20+100°C ~25'	
	15 Kg/h	15 + 15Kg/h
	25 L	25 + 25 L
	2,5 Kg	2,5 + 2,5 Kg
	400 x 700 x 1040(h) mm	800 x 700 x 1040(h) mm
		
	49 Kg	76 Kg
	59 Kg	91 Kg
	480 x 780 x 1200(h) mm	880 x 800 x 1200(h) mm
	0,449 m³	0,844 m³



# Optional cuocipasta

ACCESSORIES  
ACCESSOIRES  
ZUBEHÖR  
ACCESORIOS  
AKCECCYAPЫ

Cuocipasta elettrici/gas - Electric/gas pasta cookers - Cuiseurs à pâte électriques/gas  
Elektronudelkocher/ Gasnudelkocher - Cocedores de pasta eléctricos/gas  
Электрические/ Газовые макаронаварки

Mod.	CP11N	CP11N	CPM30 - CPM30M - CPM30DM			
	standard 2 basket	ACCECP11N optional 1 baskets	ACCE11 CE1/1	ACCE12 CE1/2	ACCE13 CE1/3	ACCE16 CE1/6
A	520 mm		420 mm	550 mm	410 mm	195 mm
B	325 mm		330 mm		290 mm	140 mm
C	190 mm		60 x 2 mm	220 mm	60 x 2 mm	60 mm
D	100 mm	210 mm	290 mm	140 mm	105 mm	
E	170 mm		205 mm			
F	225 mm		400 mm	380 mm	400 mm	
G	-					
H	200 mm		285 mm			
I	345 mm		340 mm			
L	-					
M	225 mm		310 mm			

	Cesto grande	ACCE11 CE1/1	ACCE12 CE1/2	ACCE13 CE1/3	ACCE16 CE1/6
Mod.	CP11N	CPM30 - CPM30M - CPM30DM			

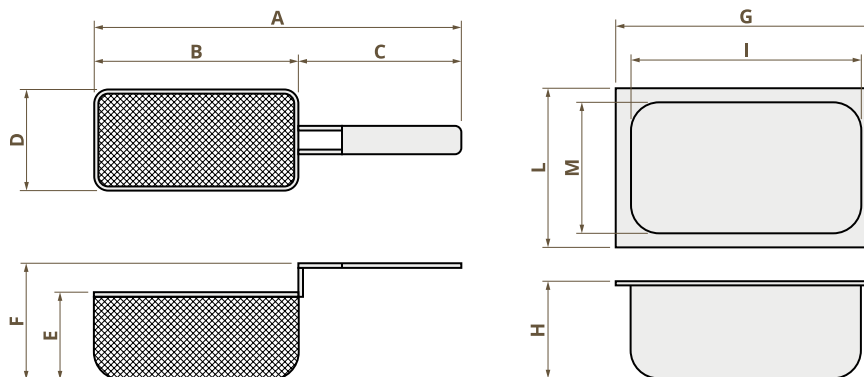

CE 1/1	CE 1/2	CE 1/2	CE 1/3		CE 1/2	CE 1/6	CE 1/6	CE 1/3		CE 1/3	CE 1/6	CE 1/6	CE 1/6	CE 1/6				
			CE 1/3					CE 1/3							CE 1/6	CE 1/6	CE 1/6	CE 1/6
			CE 1/3					CE 1/6	CE 1/6						CE 1/6	CE 1/6	CE 1/6	CE 1/6

Cuocipasta elettrici - Electric pasta cookers - Cuiseurs à pâte électriques - Elektronudelkocher  
 Cocedores de pasta eléctricos - Электрические макаронварки

CP11N

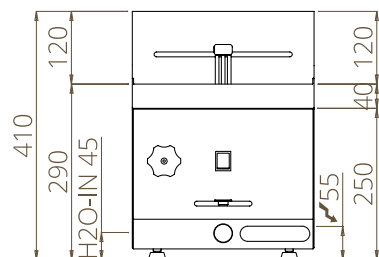

CPM30

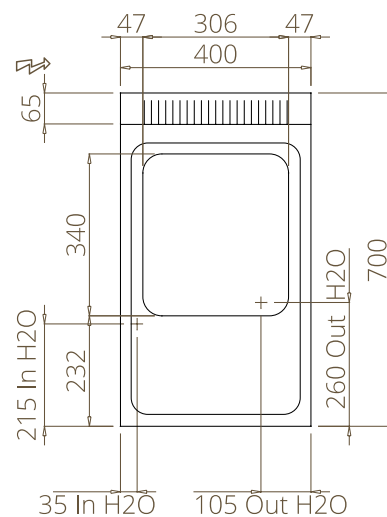
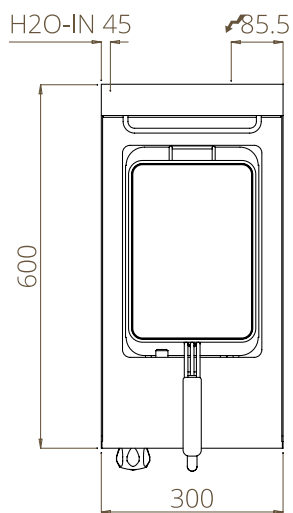
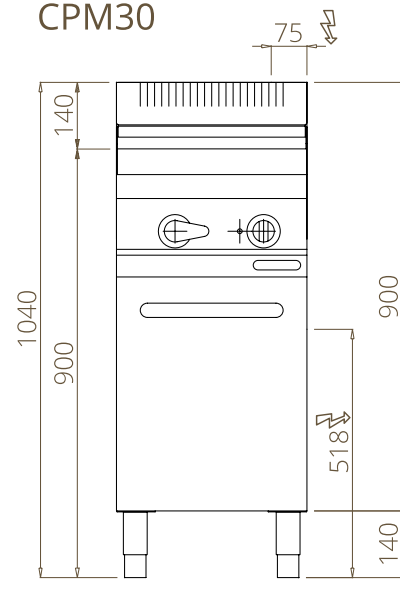



Cuocipasta a gas - Gas pasta cookers - Cuisneur à pâte à gaz - Gasnudelkocher  
 Cocedores de pasta a gas - Газовые макаронварки

CPM30M

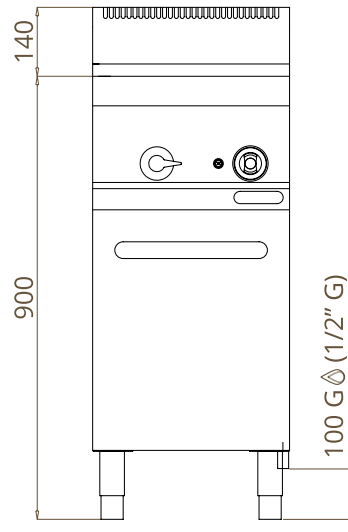

CPM30DM

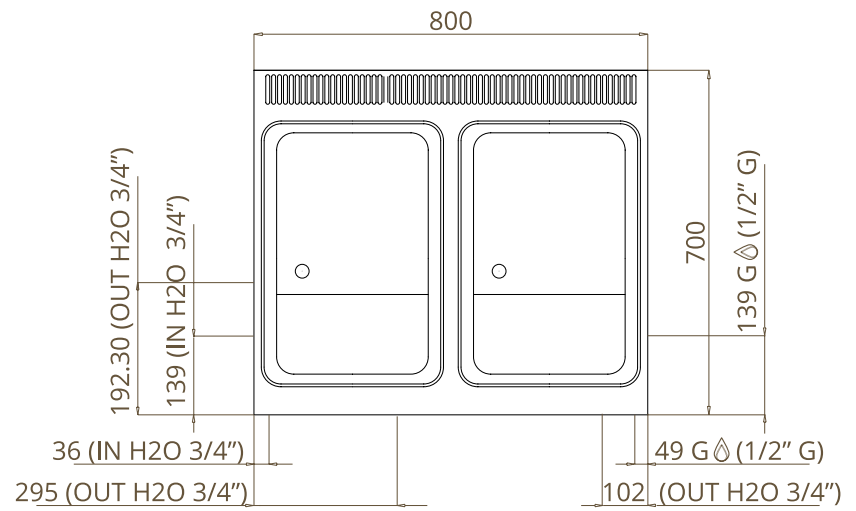
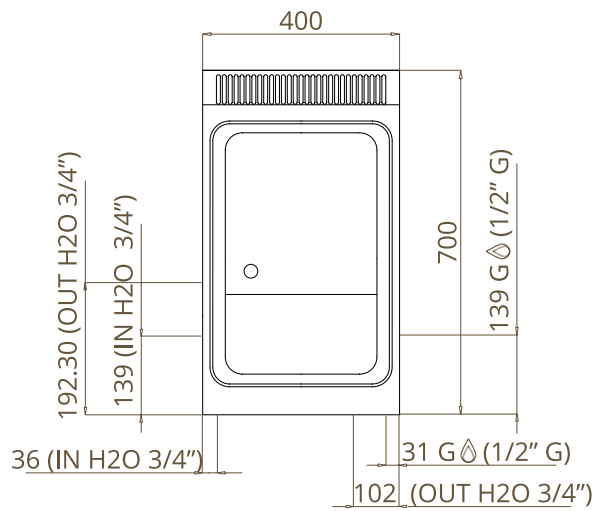
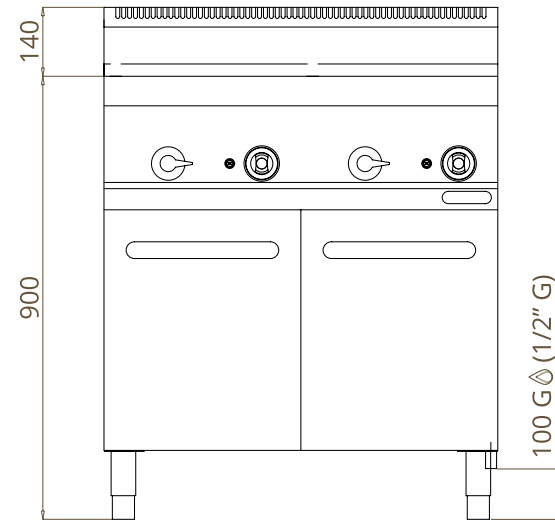

GL33  
GL66



GL33













GL66

# Griglie pietra lavica modello GL

LAVA STONE GRILL  
GRILLES À PIERRE LAVIQUE  
LAVASTEINGRILL  
PARRILLAS DE PIEDRA LÁVICA  
ГРИЛЬ С ЛАВОВЫМ КАМНЕМ

- IT** Macchina da banco per cuocere carne, pesce, verdure, ecc. Il funzionamento consiste nel riscaldare la pietra lavica posta su una griglia di supporto in acciaio. Struttura in acciaio inox - griglia di cottura in lamiere piegate a V in acciaio inox - accensione con piezoelettrico - alimentazione metano, in dotazione kit GPL - allacciamento gas 1/2"G - cassetto raccolta residui di cottura.
- EN** Tabletop appliance to cook meat, fish, vegetables, etc. The purpose is to heat the lava stone placed on a steel support grid. Stainless steel casing - stainless steel V-folded cooking grid - piezoelectric ignition - natural gas ready, supplied with LPG kit - 1/2"G gas connection - drawer for collecting cooking waste.
- FR** Machine de table pour la cuisson de viande, poisson, légumes, etc. Le fonctionnement consiste à chauffer la pierre de lave placée sur une grille de support en acier. Corps en acier Inox - grille de cuisson en acier inoxydable pliée à V - allumage piézoélectrique - alimentation en gaz naturel, fournie avec kit GPL - raccord gaz 1/2"G - tiroir de récolte des résidus de cuisson.
- DE** Aufstellgerät zum Kochen von Fleisch, Fisch, Gemüse, etc. Der Vorgang besteht in der Erwärmung des Lavasteins, der auf einem Stahlstützgitter liegt. Edelstahlgehäuse - Edelstahl V-förmig gefaltetes Gargitter - piezoelektrische Zündung - Erdgasversorgung, geliefert mit LPG-Kit - 1/2"G Gasanschluss - Kochreste Sammelfach
- ES** Máquina sobre-mesa para cocinar carne, pescado, verduras, etc. La operación consiste en calentar la piedra de lava colocada sobre una rejilla de acero. Estructura de acero inoxidable - rejilla de cocción en V de acero inoxidable - encendido piezoeléctrico - alimentada con gas natural, suministrada con kit GLP - conexión de gas 1/2"G - cajón para la recogida de los residuos de cocción.
- RU** Настольная машина для приготовления мяса, рыбы, овощей и т.д. Операция заключается в нагревании лавового камня, помещенного на стальную опорную решетку. Конструкция из нержавеющей стали - V-образная складная решетка из нержавеющей стали - пьезоэлектрическое зажигание - комплект для подключения природного газа, для подключения сжиженного газа 1/2"G - выдвижной ящик для сбора остатков пищи.

	<b>GL33</b>	<b>GL66</b>
	6,5 kW	13 kW
<b>kcal/h BTU/h</b>	5589 kcal/h 22179 BTU/h	11178 kcal/h 44358 BTU/h
<b>METANO METHANE METAHA</b>	G20 = 0,71 m³/h G25 = 0,79 m³/h	G20 = 1,42 m³/h G25 = 1,59 m³/h
<b>GPL LPG</b>	G30/G31 = 0,49 Kg/h	G30/G31 = 0,98 Kg/h
	N° 1 (Bruciatori - Burners - Горелки)	N° 2 (Bruciatori - Burners - Горелки)
	N° 1 (Piezoelettrico - Piezoelectric Пьезоэлектрический)	N° 2 (Piezoelettrico - Piezoelectric Пьезоэлектрический)
	312 x 483 mm	312 x 483 mm x 2
	330 x 625 x 300(h) mm	660 x 625 x 300(h) mm
		
	24 Kg	49 Kg
	30 Kg	55 Kg
	395 x 670 x 370(h) mm	725 x 670 x 426(h) mm
	0,097 m³	0,206 m³



GRIGLIA PESCE - FISH GRID

B50  
B80  
B115



B80



B50



B115 - CON MOBILE  
WITH HOUSING UNIT /  
ШКАФ С ДВЕРЦЕЙ И ЗАДНИМ  
ЗАКРЫТИЕМ

	Mobile - Cabinet - Meuble - Möbel - Mueble - шкаф		
	M50	M80	M115
 mm	490 x 630 x 530(h) mm	810 x 630 x 530(h) mm	1140 x 630 x 530(h) mm
 Kg	16 Kg	21 Kg	27 Kg
 Kg	18 Kg	23 Kg	31 Kg
 mm	720 x 510 x 150(h) mm	820 x 680 x 150(h) mm	1150 x 680 x 150(h) mm
 m <sup>3</sup>	0,057 m <sup>3</sup>	0,093 m <sup>3</sup>	0,129 m <sup>3</sup>

# Griglie pietra lavica modello B

LAVA STONE GRILL  
GRILLES À PIERE LAVIQUE  
LAVASTEINGRILL  
PARRILLAS DE PIEDRA LÁVICA  
ГРИЛЬ С ЛАВОВЫМ КАМНЕМ

**IT** Macchina per cuocere carne, pesce, verdure, ecc. Il funzionamento consiste nel riscaldare la pietra lavica posta su una griglia di supporto in acciaio. La macchina è dotata di una griglia di cottura in ghisa smaltata opaca che può essere utilizzata da una parte per la carne e dall'altra per il pesce. Struttura in acciaio inox - doppia parete di isolamento - accensione con piezoelettrico - alimentazione a metano, in dotazione kit GPL - allacciamento da 1/2"G - griglia di cottura brevettata, inclinabile in 4 posizioni - cassetto raccolta residui di cottura. I modelli 80 e 115 permettono la regolazione e l'accensione indipendente di metà piano di cottura.











**EN** Appliance to cook meat, fish, vegetables, etc. The purpose is to heat the lava stone placed on a steel support grid. The machine is equipped with a cast-iron matte enamelled cooking grid that can be used on one side for meat and on the other for fish. Stainless steel casing - double layer of insulation - piezoelectric ignition - natural gas ready, supplied with LPG kit - 1/2"G connection - patented cooking grid, tiltable in 4 positions - drawer to collect cooking waste. Models 80 and 115 allow independent adjustment and ignition of half-cooking plate.

**FR** Machine pour la cuisson de viande, poisson, légumes, etc. Le fonctionnement consiste à chauffer la pierre de lave placée sur une grille de support en acier. La machine est équipée d'une grille de cuisson en fonte émaillée mate qui peut être utilisée d'un côté pour la viande et de l'autre pour le poisson. Corps en acier Inox - double paroi isolante - allumage piézoélectrique - alimentation en gaz naturel, fourni avec kit GPL - raccord 1/2"G - grille de cuisson brevetée, inclinable en 4 positions - tiroir pour le recueil des restes de cuisson. Les modèles 80 et 115 permettent le réglage et l'allumage indépendant de la moitié du plan de cuisson.

**DE** Gerät zum Kochen von Fleisch, Fisch, Gemüse, usw. Der Vorgang besteht in der Erwärmung des Lavasteins, der auf einem Stahlstützgitter liegt. Die Maschine ist mit einem matt lackierten Gusseisengitter ausgestattet, das auf der einen Seite für Fleisch und auf der anderen Seite für Fisch verwendet werden kann. Edelstahlgehäuse - doppelte Isolierwand - piezoelektrische Zündung - Erdgasversorgung, Lieferung mit LPG-Kit - 1/2"G - Anschluss - patentiertes Gargitter, in 4 Positionen schwenkbar - Kochreste Sammelfach. Die Modelle 80 und 115 ermöglichen die unabhängige Einstellung und Zündung der Hälfte der Kochfläche.

**ES** Máquina para cocinar carne, pescado, verduras, etc. La operación consiste en calentar la piedra de lava colocada sobre una rejilla de acero. La máquina está equipada con una rejilla de cocción de hierro fundido esmaltado mate que se puede utilizar en un lado para la carne y en el otro lado para el pescado. Cuerpo de acero inoxidable - doble pared aislante - encendido piezoeléctrico - suministro de gas natural, suministrado con el kit GLP - conexión 1/2"G - rejilla de cocción patentada, inclinable en 4 posiciones - cajón para la recogida de los residuos de cocción. Los modelos 80 y 115 permiten el ajuste independiente y la ignición de la mitad de la superficie de cocción.

**RU** Кулинарная машина для приготовления мяса, рыбы, овощей и т.д. Операция состоит из нагреть лавовый камень, помещенный на стальную опорную решетку. Машина оснащена матовой решеткой из эмалированного чугуна, которую можно использовать с одной стороны для приготовления мяса, а с другой - для рыбы. Корпус из нержавеющей стали - двойная изолирующая стенка - пьезоэлектрическое зажигание - подача природного газа, поставляется с комплектом LPG - подключение 1/2"G - запатентованная решетка, наклоняемая в 4 положения - выдвижной ящик для сбора остатков пищи. Модели 80 и 115 позволяют независимо регулировать и зажигать половину рабочей поверхности.

	<b>B50</b>	<b>B80</b>	<b>B115</b>
	8,5 kW	17 kW	23 kW
<b>kcal/h BTU/h</b>	7.309 kcal/h 29.002 BTU/h	14.617 kcal/h 58.004 BTU/h	19.776 kcal/h 78.476 BTU/h
<b>METANO METHANE МЕТАНА</b>	G20 = 0,90 m³/h G25 = 1,05 m³/h	G20 = 1,80 m³/h G25 = 2,09 m³/h	G20 = 2,43 m³/h G25 = 2,83 m³/h
<b>GPL LPG</b>	G30/G31 = 0,67 Kg/h	G30/G31 = 1,34 Kg/h	G30/G31 = 1,81 Kg/h
	N° 3 (Bruciatori - Burners Горелки)	N° 6 (Bruciatori - Burners Горелки)	N° 8 (Bruciatori - Burners Горелки)
	N° 1 (Piezoelettrico - Piezoelectric Пьезоэлектрический)	N° 2 (Piezoelettrico - Piezoelectric - Пьезоэлектрический)	
	320 x 540 mm	640 x 540 mm	960 x 540 mm
	490 x 700 x 380(h) mm	810 x 700 x 380(h) mm	1140 x 700 x 380(h) mm
			
	44 Kg	76 Kg	108 Kg
	50 Kg	83 Kg	115 Kg
	720x 540 x 420(h) mm	850 x 740 x 420(h) mm	1180 x 740 x 420(h) mm
	0,163 m³	0,264 m³	0,036 m³

# FRY1L-FRY1LC FRY1R-FRY1RC



FRY1L



FRY1R



FRY1RC

SPATOLA INCLUSA  
SPATULA INCLUDED  
SPATULE INCLUSE  
SPACHTEL INBEGRIFFEN  
ESPÁTULA INCLUIDA  
ШПАТЕЛЯ В КОМПЛЕКТЕ













Fry Top  
elettrici

ELECTRIC FRY-TOPS  
FRY-TOP ÉLECTRIQUE  
ELEKTRISCHE FRY TOP  
FRY TOP ELÉCTRICOS  
ЭЛЕКТРИЧЕСКИЕ ЖАРОЧНЫЕ ПОВЕРХНОСТИ

- IT** Macchina elettrica per cottura a secco o ad olio. Struttura in acciaio inox - piano di cottura in acciaio sabbiato o cromato, liscio o rigato - termostati di regolazione temperatura 50÷300°C - cassetto raccolta residui di cottura.
- EN** Electric operated machine for dry or oil cooking. Stainless steel casing - smooth, grooved or mixed sanded or chromed steel cooking surface - 50÷300°C temperature adjustment thermostats - drip drawer.
- FR** Machine électrique pour la cuisson à sec ou à l'huile. Corps en acier inox - plan de cuisson en acier sablé ou chromé lisse, nervuré ou mixte - thermostats de réglage de la température de 50 à 300 °C - tiroir de récolte de résidus de cuisson.
- DE** Elektrogerät zum Trocken- oder Ölgaren. Gehäuse aus Edelstahl - Kochplatte aus sandgestrahltem oder verchromtem Stahl, glatt, gerillt oder kombiniert - Thermostat zur Einstellung der Temperatur von 50 bis 300°C - Kochreste-Sammelkasten.
- ES** Máquina eléctrica para la cocción en seco o con aceite. Estructura de acero inoxidable - plano de cocción de acero enarenado o cromado liso, rayado - termostatos de regulación de la temperatura 50÷300°C - cajón recolección residuos de cocción.
- RU** Электрический прибор для приготовления пищи на масле или без масла. Корпус из нержавеющей стали, гладкая, рифленая или комбинированная жарочная поверхность из нержавеющей стали, подвергнутой пескоструйной обработке или хромированная. Термостаты для регулировки температуры 50÷300°C, поддон для сбора отходов.



FRY1LC

	FRY1L FRY1LC	FRY1R FRY1RC
		
	3 kW	
 1 Ph	230V/1N/50-60Hz	
	50÷300°C	
	Liscia - Smooth - Гладкий	Rigata - Grooved - Рифлёный
 mm	325 x 480 mm	
 mm	335 x 570 x 300(h) mm	
		
 NET Kg	22 Kg	
 GROSS Kg	30 Kg	
 mm	670 x 410 x 430(h) mm	
 m <sup>3</sup>	0,118 m <sup>3</sup>	

# FRY2L-FRY2LC FRY2LR-FRY2LRC FRY2VCE



FRY2LR



FRY2LC

SPATOLA INCLUSA  
SPATULA INCLUDED  
SPATULE INCLUSE  
SPACHTEL INBEGRIFFEN  
ESPÁTULA INCLUIDA  
ШПАТЕЛЯ В КОМПЛЕКТЕ

Fry Top  
elettrici doppia piastra

ELECTRIC FRY-TOPS  
FRY-TOP ÉLECTRIQUE  
ELEKTRISCHE FRY TOP  
FRY TOP ELÉCTRICOS  
ЭЛЕКТРИЧЕСКИЕ ЖАРОЧНЫЕ ПОВЕРХНОСТИ



IT Macchina elettrica per cottura a secco o ad olio. Struttura in acciaio inox - piano di cottura in acciaio sabbiato o cromato liscio, rigato o misto oppure in vetroceramica (solo mod. FRY2VCE) - termostati di regolazione temperatura 50÷300°C - cassetto raccolta residui di cottura - regolazione e l'accensione indipendente di metà piano di cottura.













EN Electric operated machine for dry or oil cooking. Stainless steel casing - smooth, grooved or mixed sanded or chromed steel cooking surface or ceramic glass (mod. FRY2VCE only) - 50÷300°C temperature adjustment thermostats - drip drawer - adjustment and independent ignition of half of the cooking surface.

FR Machine électrique pour la cuisson à sec ou à l'huile. Structure en acier inox - plan de cuisson en acier sablé ou chromé lisse, nervuré ou mixte ou à vitroceramique (soulement mod. FRY2VCE) - thermostats de réglage de la température de 50 à 300°C - tiroir de récolte de résidus de cuisson. Réglage et allumage indépendant de la moitié du plan de cuisson.

DE Elektrogerät zum Trocken- oder Ölgaren. Gehäuse aus Edelstahl - Kochplatte aus sandgestrahltem oder verchromtem Stahl, glatt, gerillt, kombiniert oder Glaskeramik (nur Mod. FRY2VCE) - Thermostat zur Einstellung der Temperatur von 50 bis 300°C - Kochreste-Sammelkasten. Unabhängige Einstellung und Zündung der Hälfte der Kochfläche.

ES Máquina eléctrica para la cocción en seco o con aceite. Estructura de acero inoxidable - plano de cocción de acero enarenado o cromado liso, rayado o mixto o vitrocerámica (sólo mod. FRY2VCE)- termostatos de regulación de la temperatura 50÷300°C - cajón recolección residuos de cocción. Regulación independiente y encendido de la mitad de la superficie de cocción.

RU Электрический прибор для приготовления пищи на масле или без масла. Корпус из нержавеющей стали, гладкая, рифленая или комбинированная жарочная поверхность из нержавеющей стали, подвергнутой пескоструйной обработке или хромированный. Стекло - керамика (только для мод. FRY2VCE), термостаты для регулировки температуры 50÷300°C, поддон для сбора отходов. В двойных моделях существует возможность независимой регулировки и включения половины жарочной поверхности.

	FRY2L FRY2LC	FRY2LR FRY2LRC	FRY2VCE
	6 kW		3,6 kW
	400V/3N/50-60Hz		-
	-		230V/1N/50-60Hz
	50÷300°C		
	Liscia Smooth Гладкий	Mista Mixed комбинированная	Liscia in vitroceramica Smooth glass ceramic Стекло - керамика Гладкий
	650 x 480 mm		600 x 400 mm
	665 x 570 x 300(h) mm		680 x 530 x 110(h) mm
			
	40 Kg		13 Kg
	53 Kg		22 Kg
	750 x 670 x 430(h) mm		740 x 600 x 330(h) mm
	0,216 m³		0,146 m³



FRY2VCE

FRY1LM  
FRY1LMC  
FRY1RM  
FRY1RMC

SPATOLA INCLUSA  
SPATULA INCLUDED  
SPATULE INCLUSE  
SPACHTEL INBEGRIFFEN  
ESPÁTULA INCLUIDA  
ШПАТЕЛЯ В КОМПЛЕКТЕ



Fry Top  
gas

GAS FRY TOP  
FRY TOP A GAZ  
GAS FRY TOP  
FRY TOP A GAS  
ГАЗОВЫЕ ЖАРОЧНЫЕ ПОВЕРХНОСТИ

IT Macchina a gas per cottura a secco o ad olio. Struttura in acciaio inox - piano di cottura in acciaio sabbiato o cromato liscio, rigato o misto - alimentazione a gas metano, in dotazione kit GPL - allacciamento gas 1/2"G - manopole di regolazione potenza fiamma - cassetto raccolta residui di cottura - accensione con piezoelettrico.

EN Gas-operated machine for dry or oil cooking. Stainless steel casing - smooth, grooved or mixed sanded or chromed steel cooking surface - natural gas ready, supplied with LPG kit - 1/2"G gas connection - flame power adjustment knobs - cooking waste collection drawer - piezoelectric ignition.

FR Machine à gaz pour la cuisson à sec ou à l'huile. Corps en acier Inox - plan de cuisson lisse, nervuré ou mixte en acier sablé ou chromé - prêt pour le gaz naturel, livré avec kit GPL - raccord gaz 1/2"G - boutons de réglage de puissance de flamme - tiroir pour le recueil des restes de cuisson - allume piézoélectrique.

DE Gasgerät zum Trocken - oder Ölgaren. Gehäuse aus Edelstahl - Kochplatte aus sandgestrahltem oder verchromtem Stahl, glatt, gerillt oder kombiniert - Erdgasversorgung, LPG-Kit im Lieferumfang - 1/2"G Gasanschluss - Drehknöpfe zur Einstellung der Flammenstärke - Kochreste-Sammelkasten - Einschaltung mit Piezoelektrik.

ES Máquina a gas para la cocción en seco o con aceite. Estructura de acero inoxidable - plano de cocción de acero enarenado o cromado liso, rayado o mixto - alimentación a gas metano, en dotación kit G.P.L - conexión de gas 1/2"G - pomos de regulación potencia de la llama - cajón recolección residuos de cocción-encendido con piezoeléctricos.

RU Газовый прибор для приготовления пищи на масле или без масла. Корпус из нержавеющей стали, гладкая, рифленая или комбинированная жарочная поверхность из нержавеющей стали, подвергнутой пескоструйной обработке или хромированный, работа на сжиженном природном газе, в комплекте 1/2"G для подключения газа, ручки для регулировки мощности пламени, поддон для сбора отходов, пьезоэлектрическое зажигание.



FRY1LM

	FRY1LM FRY1LMC	FRY1RM FRY1RMC
	4 kW	
<b>kcal/h BTU/h</b>	3.308 kcal/h 13.235 BTU/h	
<b>METANO METHANE МЕТАНА</b>	G20 = 0,41 m³/h G25 = 0,51 m³/h	
<b>GPL LPG</b>	G30/G31 = 0,31 Kg/h	
	N° 1 (Bruciatori - Burners - Горелки)	
	N° 1 (Piezoelettrico - Piezoelectric - Пьезоэлектрический)	
	Liscia - Smooth - Гладкий	Rigata - Grooved - Рифлённый
	325 x 480 mm	
	355 x 600 x 300(h) mm	
	24 Kg	
	31 Kg	
	410 x 670 x 430(h) mm	
	0,118 m³	

# FRY2LM FRY2LMC FRY2LRM FRY2LRMC



FRY2LM



FRY2LRM

SPATOLA INCLUSA  
SPATULA INCLUDED  
SPATULE INCLUSE  
SPÄCHTEL INBEGRIFFEN  
ESPÁTULA INCLUIDA  
ШПАТЕЛЯ В КОМПЛЕКТЕ

Fry Top  
gas

GAS FRY TOP  
FRY TOP A GAZ  
GAS FRY TOP  
FRY TOP A GAS  
ГАЗОВЫЕ ЖАРОЧНЫЕ ПОВЕРХНОСТИ

**IT** Macchina a gas per cottura a secco o ad olio. Struttura in acciaio inox - piano di cottura in acciaio sabbiato o cromato liscio, rigato o misto - alimentazione a gas metano, in dotazione kit G.P.L - allacciamento gas 1/2"G - manopole di regolazione potenza fiamma - cassetto raccolta residui di cottura - accensione con piezoelettrico. I modelli doppi permettono la regolazione e l'accensione indipendente di metà piano di cottura.











**EN** Gas-operated machine for dry or oil cooking. Stainless steel casing - smooth, grooved or mixed sanded or chromed steel cooking surface - natural gas ready, supplied with LPG kit - 1/2"G gas connection - flame power adjustment knobs - cooking waste collection drawer - piezoelectric ignition. Dual models allow independent adjustment and ignition of the two cooking surface halves.

**FR** Machine à gaz pour la cuisson à sec ou à l'huile. Corps en acier Inox - plan de cuisson lisse, nervuré ou mixte en acier sablé ou chromé - prêt pour le gaz naturel, livré avec kit GPL - raccord gaz 1/2"G - boutons de réglage de puissance de flamme - tiroir pour le recueil des restes de cuisson - allume piézoélectrique. Les modèles doubles permettent le réglage et l'allumage indépendants des deux moitiés de la surface de cuisson.

**DE** Gasgerät zum Trocken - oder Ölgaren. Gehäuse aus Edelstahl - Kochplatte aus sandgestrahltem oder verchromtem Stahl, glatt, gerillt oder kombiniert - Erdgasversorgung, LPG-Kit im Lieferumfang - 1/2"G Gasanschluss - Drehknöpfe zur Einstellung der Flammenstärke - Kochreste-Sammelkasten - Einschaltung mit Piezoelektrik. Doppelmodelle ermöglichen die unabhängige Einstellung und Zündung der beiden Kochflächenhälften.

**ES** Máquina a gas para la cocción en seco o con aceite. Estructura de acero inoxidable - plano de cocción de acero enarenado o cromado liso, rayado o mixto - alimentación a gas metano, en dotación kit G.P.L - conexión de gas 1/2"G - pomos de regulación potencia de la llama - cajón recolección residuos de cocción-encendido con piezoeléctricos. Los modelos dobles permiten el ajuste y la ignición independientes de las dos mitades de la superficie de cocción.

**RU** Газовый прибор для приготовления пищи на масле или без масла. Корпус из нержавеющей стали, гладкая, рифленая или комбинированная жарочная поверхность из нержавеющей стали, подвергнутой пескоструйной обработке или хромированный, работа на сжиженном природном газе, в комплекте с оснасткой для работы на метане, ручки для регулировки мощности пламени, поддон для сбора отходов, пьезоэлектрическое зажигание. В двойных моделях существует возможность независимой регулировки и включения половины жарочной поверхности.

	FRY2LM FRY2LMC	FRY2LRM FRY2LRMC
		
	8 kW	
<b>kcal/h</b> <b>BTU/h</b>	3.308 + 3.308 kcal/h 13.235 + 13.235 BTU/h	
<b>METANO</b> <b>METHANE</b> <b>METAHA</b>	G20 = 0,41 + 0,41 m³/h G25 = 0,51 + 0,51 m³/h	
<b>GPL</b> <b>LPG</b>	G30/G31 = 0,31 + 0,31 Kg/h	
	N° 2 (Bruciatori - Burners - Горелки)	
	N° 2 (Piezoelettrico - Piezoelectric - Пьезоэлектрический)	
	Liscia - Smooth - Гладкий	Mista - Mixed - комбинированная
	650 x 480 mm	
	665 x 600 x 300(h) mm	
		
	42 Kg	
	55 Kg	
	750 x 670 x 430(h) mm	
	0,216 m³	



FRY2LMC

# GYR40 GYR60



GYR40



GYR60

Gyros  
elettrici

ELECTRIC GYROS  
GYROS ÉLECTRIQUES  
ELEKTRISCHER GYROS  
GYROS ELÉTRICOS  
ЭЛЕКТРИЧЕСКИЕ ВЕРТИКАЛЬНЫЕ  
ШАШЛЫЧНИЦЫ

IT Macchina per cuocere carne per Kebab. Struttura, asta spiedo e paletta raccogli carne in acciaio inox - resistenze ad infrarossi rivestite in ceramica (4 per il modello GYR40 e 6 per il modello GYR60), con vetro di protezione resistente alle alte temperature che ne facilita la pulizia e abbassa i consumi - regolazione resistenze a settori - regolazione distanza asta spiedo dalle resistenze - cassetto di raccolta residui di cottura in acciaio inox - diametro max. carne consentito 470 mm - 3 livelli di potenza.











EN Kebab cooker. Stainless steel casing, skewer and meat collection fork - ceramic coated infrared heating elements (4 for the GYR40 model and 6 for the GYR60 model), with high temperature resistant safety glass that facilitates cleaning and lowers consumption - sector heating elements adjustment - skewer distance adjustment from heating elements - drip tray - max. meat diameter allowed 470 mm - 3 power levels.

FR Cuisinière à kebab. Corps, barre de grill et pelle à viande en acier Inox - éléments chauffants infrarouges à revêtement céramique (4 pour le modèle GYR40 et 6 pour le modèle GYR60), avec verre de sécurité haute température qui facilite le nettoyage et réduit la consommation - réglage des éléments chauffants par secteur - réglage de la distance de la barre du grill des éléments chauffants - tiroir pour le recueil des restes de cuisson - diamètre maximum pour la viande 470 mm - 3 puissances.

DE Kebabherd. Gehäuse, Grillstab und Fleischschaufel aus Edelstahl - keramikbeschichtete Infrarot-Heizelemente (4 für Modell GYR40 und 6 für Modell GYR60), mit Hochtemperatur-Sicherheitsglas für eine einfache Reinigung und reduzierten Verbrauch - sektorspezifische Einstellung der Heizelemente - Einstellung des Abstandes der Grillstange zu den Heizelementen - Kochreste-Sammelkasten - maximaler Durchmesser für Fleisch 470 mm - 3 Leistungsstufen.

ES Estufa de Kebab. Cuerpo, barra de asar y pala para carne de acero inoxidable - elementos calefactores infrarrojos recubiertos de cerámica (4 para el modelo GYR40 y 6 para el modelo GYR60), con vidrio de seguridad de alta temperatura para una fácil limpieza y un consumo reducido - regulación sectorial de los elementos calefactores - regulación de la distancia de la barra de asar de la parrilla con respecto a los elementos calefactores - cajón para la recogida de los residuos de la cocción - diámetro máximo de la carne de 470 mm - 3 potencias.

RU Кебабовая плита. Корпус из нержавеющей стали, шпалка и вилка для сбора мяса - инфракрасные нагревательные элементы с керамическим покрытием (4 для модели GYR40 и 6 для модели GYR60), с термостойким безопасным стеклом, что облегчает очистку и снижает расход - регулировка нагревательных элементов сектора - регулировка расстояния между шамперами и нагревательными элементами - каплесборник - максимальный диаметр 470 мм - 3 уровня мощности.

	GYR40	GYR60
	2,8 kW	4,2 kW
	-	230-400V/3-3N/50Hz
	230V/1N/50Hz	-
	280÷320 mm	410÷460 mm
	5÷10 Kg - ø 470 mm	10÷30 Kg - ø 470 mm
	N° 4	N° 6
	510 x 530 x 750÷1220*(h) mm	510 x 530 x 870÷1340*(h) mm
		
	21 Kg	25 Kg
	32 Kg	36 Kg
	620 x 680 x 1030(h) mm*	
	0,44 m³	

\* + 500 mm

Dimensione di macchina con cappa con filtro.

Packing size with filtered hood.

Emballage avec hotte avec filtre.

Verpackungsgröße mit Filterhaube.

Embalaje con campana de filtro opcional.

Размер упаковки с дополнительным кожухом фильтра.

# GYR80 GYR100



GYR80



GYR100

Gyros  
elettrici

ELECTRIC GYROS  
GYROS ÉLECTRIQUES  
ELEKTRISCHER GYROS  
GYROS ELÉTRICOS  
ЭЛЕКТРИЧЕСКИЕ ВЕРТИКАЛЬНЫЕ  
ШАШЛЫЧНИЦЫ



**IT** Macchina per cuocere carne per Kebab. Struttura, asta spiedo e paletta raccogli carne in acciaio inox - resistenze ad infrarossi rivestite in ceramica (8 per il modello GYR80 e 10 per il modello GYR100) - vetro di protezione resistente alle alte temperature che ne facilita la pulizia e abbassa i consumi - regolazione resistenze a settori - regolazione distanza asta spiedo dalle resistenze - cassetto di raccolta residui di cottura in acciaio inox - diametro max. carne 470 mm - 3 livelli di potenza.









**EN** Kebab cooker. Stainless steel casing, skewer and meat collection fork - ceramic coated infrared heating elements (8 for the GYR80 model and 10 for the GYR100 model), with high temperature resistant safety glass that facilitates cleaning and lowers consumption - sector heating elements adjustment - skewer distance adjustment from heating elements - drip tray - max. meat diameter allowed 470 mm - 3 power levels.

**FR** Cuisinière à kebab. Corps, barre de grill et pelle à viande en acier Inox - éléments chauffants infrarouges à revêtement céramique (8 pour le modèle GYR80 et 10 pour le modèle GYR100), avec verre de sécurité haute température qui facilite le nettoyage et réduit la consommation - réglage des éléments chauffants par secteur - réglage de la distance de la barre du grill des éléments chauffants - tiroir pour le recueil des restes de cuisson - diamètre maximum pour la viande 470 mm - 3 puissances.

**DE** Kebabherd. Gehäuse, Grillstab und Fleischschaufel aus Edelstahl-keramikbeschichtete Infrarot-Heizelemente (8 für Modell GYR80 und 10 für Modell GYR100), mit Hochtemperatur-Sicherheitsglas für eine einfache Reinigung und reduzierten Verbrauch - sektorspezifische Einstellung der Heizelemente - Einstellung des Abstandes der Grillstange zu den Heizelementen - Kochreste-Sammelkasten - maximaler Durchmesser für Fleisch 470 mm - 3 Leistungsstufen.

**ES** Estufa de Kebab. Cuerpo, barra de asar y pala para carne de acero inoxidable - elementos calefactores infrarrojos recubiertos de cerámica (8 para el modelo GYR80 y 10 para el modelo GYR100), con vidrio de seguridad de alta temperatura para una fácil limpieza y un consumo reducido - regulación sectorial de los elementos calefactores - regulación de la distancia de la barra de asar de la parrilla con respecto a los elementos calefactores - cajón para la recogida de los residuos de la cocción - diámetro máximo de la carne de 470 mm - 3 potencias.

**RU** Кебабовая плита. Корпус из нержавеющей стали, шпажка и вилка для сбора мяса - инфракрасные нагревательные элементы с керамическим покрытием (8 для модели GYR80 и 10 для модели GYR100), с термостойким безопасным стеклом, что облегчает очистку и снижает расход - регулировка нагревательных элементов сектора - регулировка расстояния между шампурами и нагревательными элементами - каплесборник - максимальный диаметр 470 мм - 3 уровня мощности.

	<b>GYR80</b>	<b>GYR100</b>
	5,6 kW	7 kW
	230-400V/3-3N/50Hz	
	590÷640 mm	710÷760 mm
	30÷65 Kg - ø 470 mm	50÷85 Kg - ø 470 mm
	N° 8	N° 10
	510 x 530 x 1060÷1530*(h) mm	510 x 530 x 1220÷1690*(h) mm
		
	28 Kg	33 Kg
	39 Kg	44 Kg
	620 x 680 x 1250(h) mm*	
	0,53 m <sup>3</sup>	

\* + 500 mm

Dimensione di macchina e imballo con cappa con filtro.

Packing size with filtered hood.

Emballage avec hotte avec filtre.

Verpackungsgröße mit Filterhaube.

Embalaje con campana de filtro opcional.

Размер упаковки с дополнительным кожухом фильтра.

# GYR60M GYR80M GYR80MD



GYR60M



GYR80MD



GYR80M

Gyros  
a gas

GAS GYROS  
GYROS A' GAZ  
GAS GYROS  
GYROS DE GAS  
ГАЗОВЫЕ ВЕРТИКАЛЬНЫЕ  
ШАШЛЫЧНИЦЫ

IT Macchina per cuocere carne per Kebab. Struttura, asta, spiedo e paletta raccogli carne in acciaio inox - bruciatori ad infrarossi con piastra in ceramica - rete protezione bruciatori asportabile - regolazione bruciatori a settori - accensione con piezoelettrico - alimentazione a metano, in dotazione kit GPL - regolazione distanza asta spiedo dalle resistenze - cassetto di raccolta residui di cottura in acciaio inox. Allacciamento gas 1/2"G.















EN Kebab cooker - stainless steel casing, skewer and meat collection fork - infrared burners with ceramic plate - removable burner protection net - burner regulation by sectors - ignition with piezoelectric - natural gas ready, supplied with LPG kit - skewer distance adjustment from heating elements - stainless drip tray. 1/2"G gas connection.

FR Cuisinière à kebab - corps, barre de grill et pelle à viande en acier Inox - brûleurs infrarouges avec plaque céramique - protection de brûleur amovible - régulation des brûleurs à secteur - allumage piézo-électrique - alimentation gaz naturel, kit GPL inclus - réglage de la distance de la barre du grill des éléments chauffants - tiroir pour le recueil des restes de cuisson. Raccord gaz 1/2"G.

DE Kebabherd - Gehäuse, Grillstab und Fleischschaufel aus Edelstahl - Infrarotbrenner mit Keramikplatte - abnehmbares Brennerschutznetz - Sektorbrennerregelung - piezoelektrische Zündung - Erdgasversorgung, LPG-Kit mitgeliefert - Einstellung des Abstandes der Grillstange zu den Heizelementen - Kochreste-Sammelkasten. Gasanschluss 1/2"G.

ES Estufa de Kebab - cuerpo, barra de asar y pala para carne de acero inoxidable - quemadores infrarrojos con placa cerámica - red desmontable de protección de los quemadores - regulación de los quemadores del sector - encendido piezoeléctrico - suministro de gas natural, kit GLP incluido - regulación de la distancia de la barra de asar de la parrilla con respecto a los elementos calefactores - cajón para la recogida de los residuos de la cocción. Conexión de gas 1/2"G.

RU Кабинная печь - корпус из нержавеющей стали, барбекю-бар и лопатка - инфракрасные горелки с керамической плитой - съемная защитная сетка горелки - регулирование секторных горелок - пьезоэлектрическое зажигание - подача природного газа, в комплект поставки входит набор LPG - регулирование расстояния гриль-барбекю от нагревательных элементов - ящик для сбора отходов приготовления. Подключение газа 1/2 "G.

	<b>GYR60M</b>	<b>GYR80M</b>	<b>GYR80MD</b>
	10,2 kW	13,6 kW	13,6 + 13,6 kW
	8772 kcal/h 34810 BTU/h	11696 kcal/h 46413 BTU/h	11696 + 11696 kcal/h 46413 + 46413 BTU/h
	G20 = 1,05 m³/h G25 = 1,23 m³/h	G20 = 1,27 m³/h G25 = 1,48 m³/h	G20 = 1,27 + 1,27 m³/h G25 = 1,48 + 1,48 m³/h
	G30/G31 = 0,71 Kg/h	G30/G31 = 0,95 Kg/h	G30/G31 = 0,95 + 0,95 Kg/h
	N° 6 (Bruciatori - Burners Горелки)	N° 8 (Bruciatori - Burners Горелки)	N° 8 + 8 (Bruciatori - Burners Горелки)
	470÷520 mm	630÷680 mm	620÷670 mm
	10÷30 Kg ø 500 mm	30÷65 Kg ø 500 mm	50÷80 Kg ø 580 mm
	480 x 500 x 940÷1210*(h) mm	480 x 500 x 1105÷1375*(h) mm	570 x 620 x 1120÷1590*(h) mm
			
	27 Kg	33 Kg	48 Kg
	38 Kg	44 Kg	59 Kg
	620 x 680 x 1030(h) mm*	620 x 680 x 1250(h) mm*	
	0,44 m³	0,53 m³	

\* + 500 mm

Dimensione di macchina e imballo con cappa con filtro.

Packing size with filtered hood.

Emballage avec hotte avec filtre.

Verpackungsgröße mit Filterhaube.

Embalaje con campana de filtro opcional.

Размер упаковки с дополнительным кожухом фильтра.





GYR100







GYR80M

Optional  
gyros

ACCESSORIES  
ACCESSOIRES  
ZUBEHÖR  
ACCESORIOS  
AKCECCYAPЫ

	<p>Coltello elettrico professionale con trasformatore. Professional electric knife with transformer. Couteau électrique professionnel avec transformateur. Professionelles elektrisches Messer mit Stromwandler. Cuchilla eléctrica profesional con transformador. Электрический профессиональный нож с трансформатором.</p>	<p>Coltello elettrico professionale con trasformatore, regolazione automatica potenza motore. Professional electric knife with transformer, automatic engine control. Couteau électrique professionnel avec transformateur, régulation automatique de la puissance du moteur. Professionelles elektrisches Messer mit Stromwandler, automatische Motorleistungseinstellung. Cuchilla eléctrica profesional con transformador, regulación automática de la potencia del motor. Электрический профессиональный нож с трансформатором, автоматической регулировкой мощности двигателя.</p>
Mod.	ACCOLGYR80D	ACCOLGYR80HM
	ø 80 mm	ø 80 mm
		

	<p>Coltello elettrico Electric knife Couteau électrique Elektrisches Messer Cuchilla eléctrica Электрический нож MADE IN CHINA</p>	<p>Kit vetri di protezione Safety glass set Kit verre de protection Schutzglas-Set Kit de cristales de protección Набор защитных стёкол</p>	<p>Cappa con filtro a carboni attivi Hood with active carbon filter Capot avec filtre à charbon actif Haube mit Aktivkohlefilter Campana con filtro de carbón activo Вытяжка с фильтром из активированного угля</p>
Mod.	ACCOLGYR100	GYR40 - GYR60	GYR80 - GYR100
	ø 100 mm		
			
			ACCAGYR PER GYROS / FOR GYROS

# RS40 RS70 SAL600MB



RS40



SAL600MB



RS70

Salamandre

SALAMANDERS  
SALAMANDER  
SALAMANDER  
SALAMANDRAS  
ГРИЛЬ САЛАМАНДР

IT Macchina per scaldare, gratinare e tostare. Struttura in acciaio inox - griglia cromata e cassetto raccolta residui di cottura removibili - termostati con 3 regolazioni di potenza - regolazione posizione griglia. Il modello SAL600MB ha la testa mobile.

EN Heating, grating and toasting appliance. Stainless steel casing - chrome-plated grill and removable cooking waste collection drawer - thermostats with 3 power settings - grill position settings. The model SAL600MB has a tilting top.

FR Machine pour chauffer, gratiner et griller des aliments. Structure en acier Inox - grille chromée et tiroir de récupération des résidus de cuisson amovible - thermostats avec 3 réglages de puissance - réglage de la position de la grille. Le modèle SAL600MB a une tête pivotante.

DE Maschine zum Erwärmen, Gratинieren und Toasten von Speisen. Edelstahlgehäuse - verchromter Grill und herausnehmbare Kochrückständen Sammelfach - Thermostate mit 3 Leistungsstufen - Grillpositionseinstellungen. Das Modell SAL600MB hat einen beweglichen Kopf.

ES Estructura de acero inoxidable - parrilla cromada y cajón recolección residuos de cocción extraíble - termostato regulación potencia - regulación posición parrilla. El modelo SAL600MB posee el cabezal móvil.

RU Корпус из нержавеющей стали, съемные хромированная решетка и поддон для сбора отходов, термостаты для регулирования мощности, регулировка положения решетки. Модель SAL600MB имеет подвижный верхний нагревательный блок.

	RS40	RS70	SAL600MB
	2,2 kW	3,2 kW	4,7 kW
	-		400V/3N/50-60Hz
	230V/1N/50-60Hz		-
	70±210 mm		110±270 mm
	400 x 290 mm	670 x 290 mm	530 x 325 mm
	600 x 370 x 400(h) mm	880 x 370 x 400(h) mm	600 x 560 x 620(h) mm
			
	15 Kg	21 Kg	47 Kg
	17 Kg	23 Kg	59 Kg
	650 x 450 x 460(h) mm	930 x 470 x 470(h) mm	670 x 630 x 880(h) mm
	0,138 m³	0,205 m³	0,371 m³





# Snack Bar

SNACK BAR  
ЗАКУСОЧНАЯ



## IT

Ultima sezione è quella dedicata alla piccola ristorazione e ai bar.

Macchinari di alta qualità italiana per preparare freschi e gustosi cocktail, frappè, spremute ma anche gustosi panini, toast, crepé o hotdog. Macchine per Frappè, Frullatori, Spremiagrumi, Tritaghiaccio, Gruppi Multipli, Piastre Elettriche, Crepiere, Toastiere, Hot Dog e Pressagelato.

## FR

La dernière section est dédiée aux petits restaurants et bars.

Machines de qualité italienne pour préparer des cocktails, milkshakes, jus de fruits frais et savoureux, mais aussi des sandwiches, toasts, crêpes ou hot-dogs succulents. Machines pour Frappé, Mélangeurs, Centrifugeuses, Concasseurs à glace, Groupes Multiples, Plaques électriques, Crêpières, Grille-pain, Hot-dogs et Presse à glace.

## ES

La última sección es la que dedicamos a los bares y pequeños restaurantes.

Máquinas de calidad italiana para preparar cocteles frescos y sabrosos, batidos, zumos y también bocadillos, tostadas, crepes o perritos calientes. Batidoras para granizados o batidos, licuadoras, exprimidores, picadoras de hielo, grupo múltiples, placas eléctricas, máquina para crepes, tostadoras, máquina para perritos calientes y prensadores para helado.

## EN

The last section is dedicated to small restaurants and bars.

Italian quality machinery to prepare fresh and tasty cocktails, milkshakes, juices but also delicious sandwiches, toasts, crêpes or hotdogs. Milkshake Machines, Blenders, Juicers, Ice Crushers, Multiple Groups, Electric Plates, Crêpes Machines, Toasters, Hot Dogs and Ice Cream Presses.

## DE

Im letzten Abschnitt geht es um kleine Restaurants und Bars.

Maschinen von italienischer Qualität zur Zubereitung von frischen und leckeren Cocktails, Milchshakes, Säften, aber auch von köstlichen Sandwiches, Toasts, Crepes oder Hotdogs. Maschinen für Frappé, Mixer, Entsafter, Eisbrecher, Multizweckanlagen, Elektroplatten, Crêpes-Maschinen, Toaster, Hot Dogs und Eis-Pressen.

## RU

Последний раздел посвящен небольшим ресторанам и барам.

Машины итальянского качества для приготовления свежих и вкусных коктейлей, молочных коктейлей, соков, а также вкусных сэндвичей, тостов, блинов или хот-догов. Машины для фраппе, блендеров, соковыжималок, ледяных дробилок, нескольких групп, электроплит, блинов, тостеров, хот-догов и прессов.

FR150I  
FR150P  
FR200P



FR150I



FR150P

Frullatori

MIXERS  
MIXEURS  
MIXER  
BATIDORAS  
БЛЕНДЕРЫ

IT Macchina per preparare frullati, frappè ecc. Struttura in lega di alluminio verniciato - microinterruttore su coperchio - coltello removibile a quattro lame in acciaio inox - tappo su coperchio per aggiungere ingredienti in fase di lavoro - disponibile con bicchiere in lexan o acciaio inox. Il modello FR200P è dotato di variatore di velocità  
Optional: Bicchiere inox o lexan per frullati o per frappè.

EN Smoothie & milkshake maker etc. Coated aluminium alloy casing - microswitch on lid - removable four-blade knife in stainless steel - cap on lid to add extra ingredients during processing - available with lexan or stainless steel cup. The FR200P model is equipped with a speed controller.  
Optional: Stainless steel or lexan cup for smoothies or milkshakes.

FR Machine pour préparer les jus à base de fruits, les frappé, etc. Corps en alliage d'aluminium peint - le modèle FR200P a le variateur de vitesse - micro-contact sur le couvercle - couteau amovible à quatre lames en acier inox - bouchon sur le couvercle pour ajouter des ingrédients durant le travail - disponible avec un verre en lexan ou en acier inox  
Extras: Verre en inox ou lexan pour les jus ou les frappés.

DE Maschine zur Zubereitung von Mixgetränken, Milkshakes usw. Gehäuse aus lackierter Aluminiumlegierung - das Modell FR200P verfügt über einen Geschwindigkeitsregler - Mikroschalter auf dem Deckel - abnehmbares Messer mit vier Klingen ausEdelstahl - Öffnung auf dem Deckel für die Zugabe der Zutaten in der Arbeitsphase - erhältlich mit Becher aus Lexan oder Edelstahl.  
Optionals: Becher aus Edelstahl oder Lexan für Mixgetränke oder Milkshakes.

ES Máquina para preparar batidos, granizados, etc. Estructura de aleación de aluminio pintado - microinterruptor en la tapa - cuchillo extraíble de cuatro cuchillas de acero inoxidable - tapón en la tapa para añadir ingredientes durante el funcionamiento - disponible con vaso de lexan o de acero inoxidable. El modelo FR200P tiene un variador de velocidad.  
Accesorios: vaso de acero inoxidable o de lexan para batidos o para granizados.

RU Прибор для приготовления коктейлей, фραπε и т.д. Окрашенный корпус из легкого алюминиевого сплава - модель FR200P имеет регулятор скорости - микровыключатель на крышке - четырехлопастной съемный нож из нержавеющей стали - пробка на крышке для добавления ингредиентов в ходе работы - предлагается в исполнении со стаканом из лексана или из нержавеющей стали.  
Аксессуары: стакан из нержавеющей стали или из лексана для приготовления коктейлей или фραπε.

	FR150I FR150P	FR200P
	0,35 kW	0,75 kW
 1 Ph	230V/1N/50-60Hz	
 RPM	16000 rpm	14000÷24000 rpm
	1,5 L	2 L
	210 x 210 x 490(h) mm	210 x 215 x 485(h) mm
		
 NET Kg	4 Kg	5 Kg
 GROSS Kg	5,4 Kg	6,5 Kg
 mm	300 x 300 x 530(h) mm	
 m <sup>3</sup>	0,048 m <sup>3</sup>	

FR2150I  
FR2150P



FR2150I

Frullatori

MIXERS  
MIXEURS  
MIXER  
BATIDORAS  
БЛЕНДЕРЫ

IT Macchina per preparare frullati, frappè ecc. Struttura in lega di alluminio verniciato - microinterruttore su coperchio - coltello removibile a quattro lame in acciaio inox - tappo su coperchio per aggiungere ingredienti in fase di lavoro - disponibile con bicchiere in lexan o acciaio inox. I modelli doppi sono dotati di un gruppo coltello ed un gruppo mescolatore.  
Optional: Bicchiere inox o lexan per frullati o per frappè.

EN Smoothie & milkshake maker etc. Coated aluminium alloy casing - microswitch on lid - removable four-blade knife in stainless steel - cap on lid to add extra ingredients during processing - available with lexan or stainless steel cup. Dual models are equipped with blades unit and mixing unit.  
Optional: Stainless steel or lexan cup for smoothies or milkshakes.

FR Machine pour préparer les jus à base de fruits, les frappé, etc. Corps en alliage d'aluminium peint - micro-contact sur le couvercle - couteau amovible à quatre lames en acier inox - bouchon sur le couvercle pour ajouter des ingrédients durant le travail - disponible avec un verre en lexan ou en acier inox. Les modèles doubles sont munis d'un groupe de couteaux et d'un groupe mélangeur.  
Extras: Verre en inox ou lexan pour les jus ou les frappés.

DE Maschine zur Zubereitung von Mixgetränken, Milkshakes usw. Gehäuse aus lackierter Aluminiumlegierung - das Modell FR200P verfügt über einen Geschwindigkeitsregler - Mikroschalter auf dem Deckel - abnehmbares Messer mit vier Klingen ausEdelstahl - Öffnung auf dem Deckel für die Zugabe der Zutaten in der Arbeitsphase - erhältlich mit Becher aus Lexan oder Edelstahl. Die Doppelte-Modelle sind mit einer Messergruppe und einer Mixer- Gruppe ausgestattet.  
Optionals: Becher aus Edelstahl oder Lexan für Mixgetränke oder Milkshakes.

ES Máquina para preparar batidos, granizados, etc. Estructura de aleación de aluminio pintado - microinterruptor en la tapa - cuchillo extraíble de cuatro cuchillas de acero inoxidable - tapón en la tapa para añadir ingredientes durante el funcionamiento - disponible con vaso de lexan o de acero inoxidable. Los modelos dobles tienen un grupo cuchilla y un grupo mezclador.  
Accesorios: vaso de acero inoxidable o de lexan para batidos o para granizados.

RU Прибор для приготовления коктейлей, фραπε и т.д. Окрашенный корпус из легкого алюминиевого сплава - микровыключатель на крышке - четырехлопастной съемный нож из нержавеющей стали - пробка на крышке для добавления ингредиентов в ходе работы - предлагается в исполнении со стаканом из лексана или из нержавеющей стали. Двухстаканные модели оснащены одним ножевым блоком и одним смесительным.  
Аксессуары: стакан из нержавеющей стали или из лексана для приготовления коктейлей или фραπε.

	FR2150I	FR2150P
	0,35 + 0,35 kW	
	230V/1N/50-60Hz	
 RPM	2 x 16000 rpm	
	1,5 + 1,5 L	
	380 x 210 x 490(h) mm	
		
	8,5 Kg	
	10 Kg	
	530 x 310 x 530(h) mm	
	0,087 m³	



FR150I



FR150P



FR2150I

# Optional frullatori

ACCESSORIES  
ACCESSOIRES  
ZUBEHÖR  
ACCESORIOS  
AKCECCYAPЫ



1,5 L

**ACB150PL**  
Bicchiere lexan  
gruppo coltelli.  
Lexan container with blades.  
Verre lexan du groupe  
de couteaux.  
Becher aus Lexan  
für Messereinheit.  
Vaso de lexan  
con grupo de cuchillas.  
Стаканы из лексана,  
узел ножей.

**ACB150PF**  
Bicchiere lexan  
gruppo mescolatore.  
Lexan container  
with shaker.  
Verre lexan du groupe  
mélangeur.  
Becher aus Lexan für  
Mixereinheit.  
Vaso de lexan  
con grupo mezclador.  
Стаканы из лексана,  
узел смесителя.

**ACB150IL**  
Bicchiere inox gruppo coltelli.  
Stainless steel container  
with blades.  
Verre inox du groupe  
de couteaux.  
Becher ausEdelstahl  
für Messereinheit.  
Vaso de acero inoxidable  
con grupo de cuchillas.  
Стаканы из нержавеющей  
стали, узел ножей.

**ACB150IF**  
Bicchiere inox  
gruppo mescolatore.  
Stainless steel container  
with shaker.  
Verre inox du groupe  
mélangeur .  
Becher aus Edelstahl  
für Mixereinheit.  
Vaso de acero inoxidable  
congrupo mezclador.  
Стаканы из нержавеющей  
стали, узел смесителя.



2 L

**ACB200PL**  
Bicchiere lexan gruppo coltelli  
Lexan container with blades  
Verre lexan du groupe de couteaux  
Becher aus lexan für Messereinheit  
Vaso de lexan con grupo cuchilla  
Стаканы из лексана, узел ножей

**ACB200PF**  
Bicchiere lexan gruppo mescolatore  
Lexan container with shaker  
Verre lexan du groupe mélangeur  
Becher aus lexan für Mixereinheit  
Vaso de lexan con grupo mezclador  
Стаканы из лексана, узел смесителя



# FP1I-FP1P FP2I-FP2P



FP1P

FP1I



FP2I













FP2P

Frullatori frappé

MILKSHAKERS  
BLENTERS À FRAPPÉS  
MILKSHAKER  
LICUADORAS FRAPPÉ  
БЛЕНДЕРЫ ДЛЯ ПРИГОТОВЛЕНИЯ ФРАППЕ



- IT Macchina per realizzare frappè, cocktails, sorbetti ecc. Struttura in lega di alluminio - disponibile con bicchiere in lexan o acciaio inox - sistema di accensione automatica solo con bicchiere inserito.
- EN Milkshake, cocktail, sherbet , etc. machine. Structure made of aluminium alloy - available with the cup in Lexan or in stainless steel - automatic power on system only with the cup inserted.
- FR Machine pour la préparation de milkshakes, cocktails, sorbets, etc. Corps en alliage d'aluminium - disponible avec verre lexan ou en acier Inox - système d'allumage automatique uniquement avec verre inséré.
- DE Gerät zur Zubereitung von Milchshakes, Cocktails, Sorbets, etc. Gehäuse aus Aluminiumlegierung - erhältlich mit Lexan- oder Edelstahlbecher - automatische Zündung nur mit eingelegtem Becher.
- ES Máquina para realizar batidos, cócteles, sorbetes, etc. Estructura de aleación de aluminio - disponible con vaso de lexan o de acero inoxidable - sistema de encendido automático sólo con el vaso enganchado.
- RU Прибор для приготовления фрэппе, коктейлей, сорбета и т.п. Корпус из легкого алюминиевого сплава, предлагается в исполнении со стаканом из лексана или из нержавеющей стали, автоматическая система включения, срабатывающая только при установленном стакане.

	FP1I	FP1P	FP2I	FP2P
				
	0,12 kW		0,12 + 0,12 kW	
	230V/1N/50-60Hz			
	16000 rpm			
	0,5 L		0,5 + 0,5 L	
	150 x 195 x 485(h) mm		300 x 195 x 485(h) mm	
				
	2,5 Kg		5 Kg	
	3,5 Kg		6,5 Kg	
	210 x 250 x 570(h) mm		370 x 250 x 530(h) mm	
	0,030 m³		0,049 m³	



SPM  
SPL



SPM



SPL

Spremiagrumi

JUICE SQUEEZER  
PRESSE-AGRUMES  
ZITRUSPRESSE  
EXPRIMIDOR  
СОКОВЫЖИМАЛКИ  
ДЛЯ ЦИТРУСОВЫХ

IT Spremiagrumi elettrici professionali in lega di alluminio verniciato - vasca, filtro e pigna estraibili - doppia pigna in ABS alimentare. SPM accensione e spegnimento automatici tramite pressione sulla pigna - SPL accensione e spegnimento automatici tramite l'utilizzo della leva premi-frutta.

EN Professional electric juicer in coated aluminium alloy - removable bowl, filter and cone - double cone in alimentary ABS. SPM automatic switching on and off by pressing on the cone - SPL automatic switching on and off by using the fruit-press lever.

FR Extracteur de jus électrique professionnel en alliage d'aluminium peint - réservoir amovible, filtre et cône - double cône en ABS alimentaire. SPM: mise en marche et arrêt automatique par pression sur le cône - SPL: mise en marche et arrêt automatique SPL à l'aide du levier de la presse à fruits.

DE Professioneller elektrischer Entsafter aus lackierter Aluminiumlegierung - abnehmbarer Behälter, Filter und Kegel - Doppelkegel aus lebensmitteltauglichem ABS. SPM automatisches Ein- und Ausschalten durch Drücken des Kegels - SPL automatisches Ein- und Ausschalten durch Drücken des Fruchtpressenhebels.

ES Exprimidores eléctricos profesionales de aleación de aluminio pintado - recipiente, filtro y cono extraíbles - doble cono de ABS de uso alimentario. SPM: encendido y apagado automáticos presionando el cono. SPL: accionamiento y apagado automáticos con la palanca empujadora de la fruta.

RU Профессиональная электрическая соковыжималка для цитрусовых из окрашенного алюминиевого сплава - съемные чаша и фильтр - автоматическое включение и выключение путем нажатия на выжимной конус - двойной выжимной конус из пищевого АБС-пластика. SPL: Профессиональная электрическая соковыжималка для цитрусовых из окрашенного алюминиевого сплава - автоматическое включение и выключение при нажатии и отпуске прижимного рычага для фруктов - съемные чаша, фильтр и выжимной конус.

	SPM	SPL
	0,15 kW	
	230V/1N/50-60Hz	
	500 rpm	
	210 x 305 x 330(h) mm	210 x 305 x 365(h) mm
		
	4 Kg	4,5 Kg
	5 Kg	5,5 Kg
	300 x 390 x 440(h) mm	
	0,051 m <sup>3</sup>	



# TRL ROGM



TRL



ROGM

Tritaghiaccio

ICE CRUSHER  
BROYEUR À GLACE  
EISMÜHLE  
PICADORA DE HIELO  
ЛЕДОВАЯ ДРОБИЛКА

IT Tritaghiaccio professionali adatti per la preparazione di granite e cocktails.  
**ROGM:** Struttura in lega di alluminio verniciato - microinterruttore su coperchio - bicchiere e gruppo lame in acciaio inox - regolazione dimensione ghiaccio tritato. Produzione di ghiaccio a pezzi per cocktails.  
**TRL:** Struttura in ABS - microinterruttore su leva - tramoggia in lega leggera - lama in acciaio inox - espulsione ghiaccio a gravità. Produzione di ghiaccio tritato per granite.











EN Professional ice crusher perfect to prepare granite and cocktails.  
**ROGM:** casing in coated aluminium alloy - microswitch on lid - cup and blade group made of stainless steel - crushed ice size adjustment. Production of ice in pieces for cocktails.  
**TRL:** ABS casing - microswitch on lever - light alloy hopper - stainless steel blade - gravity ice ejection. Production of crushed ice for granite.

FR Broyeur à glace professionnel pour la préparation des granites et des cocktails.  
**ROGM:** Structure en alliage d'aluminium verni - microinterrupteur sur le couvercle - verre et groupe de lames en acier inox - réglage de la taille de la glace pilée. Production de glace en morceaux pour cocktails.  
**TRL:** Structure en ABS - micro-interrupteur sur levier - trémie en alliage léger - lame en acier inox - éjection de glace par gravité. Production de glace concassée pour les granites.

DE Professioneller Eisbrecher für die Zubereitung von Granite und Cocktails.  
**ROGM:** Gehäuse aus lackierter Aluminiumlegierung - Mikroschalter am Deckel - Becher- und Klingengruppe aus Edelstahl - Eisgrößenverstellung. Herstellung von Eis in Stücken für Cocktails.  
**TRL:** Gehäuse aus ABS - Mikroschalter am Hebel - Trichter aus Leichtmetall - Edelstahlklinge - Schwerkraft-Eiswurf. Produktion von Scherbeneis für Granit.

ES Picadoras de hielo profesionales para granizados y cócteles. deshacer el hielo en delicadas  
**ROGM:** estructura de aleación de aluminio pintado - microinterruptor en la tapa - vaso y grupo cuchillas de acero inoxidable - regulador de la medida del hielo triturado. Produce hielo en pedazos para cócteles.  
**TRL:** Estructura de ABS - microinterruptor en la palanca - tolva de aleación ligera - cuchilla de acero inoxidable - expulsión del hielo por gravedad. Produce hielo triturado para granizados.

RU Профессиональная дробилка для измельчения льда, подходящая для приготовления гранита и коктейлей.  
**ROGM:** Конструкция из окрашенного алюминиевого сплава - микровыключатель на крышке - стекло и группа лопаток из нержавеющей стали - регулировка размера измельченного льда. Производство льда кусочками для коктейлей.  
**TRL:** Структура ABS - микровыключатель на рычаге - бункер из легкого сплава - лезвие из нержавеющей стали - гравитационный выброс льда. Производство щебня для гранита.

	ROGM	TRL
	0,15 kW	0,35 kW
	230V/1N/50-60Hz	
	800 rpm	1200 rpm
	~120 Kg/h	
	3 L	-
	210 x 380 x 490(h) mm	210 x 465 x 310(h) mm
		
	5 Kg	8 Kg
	6 Kg	9 Kg
	300 x 300 x 530(h) mm	280 x 540 x 310(h) mm
	0,047 m³	0,046 m³

GP2SF  
GP2FR  
GP3SFF



GP2FR



GP3SFF



GP2SF

Gruppi multipli

MULTIPLE GROUP  
GROUPE MULTIPLE  
MULTI-EINHEIT  
GRUPO MÚLTIPLE  
БАРНЫЙ КОМБАЙН

IT Macchine per realizzare contemporaneamente più lavorazioni. Struttura in lega leggera di alluminio verniciato - motori indipendenti.  
**GP2SF:** composto da spremiagrumi e frullatore con bicchiere da 1,5 L in lexan.  
**GP2FR:** composto da frullatore con bicchiere da 1,5 L in lexan e rompighiaccio con bicchiere in acciaio inox.  
**GP3SFF:** composto da spremiagrumi a leva, frullatore con bicchiere da 1,5 L in lexan e frappe con bicchiere in lexan.

EN Multi-purpose appliances. Painted aluminium alloy casing - independent motors.  
**GP2SF:** composed of a citrus juicer and mixer with 1.5 L lexan cup.  
**GP2FR:** composed of a mixer with 1.5 L lexan cup and ice crusher with stainless steel cup.  
**GP3SFF:** composed of a citrus juicer, mixer with 1.5 L lexan cup and milkshaker with lexan cup.

FR Machines pour préparer simultanément plusieurs recettes. Corps en alliage d'aluminium léger verni - moteurs indépendants.  
**GP2SF:** composé d'une presse-fruits et d'un mélangeur avec verre lexan de 1,5 L  
**GP2FR:** composé d'un mixer avec verre lexan de 1,5 L et d'un brise-glace avec verre en acier Inox.  
**GP3SFF:** composé d'un presse-fruits à levier, d'un mixeur avec verre de 1,5 L en lexan et mixeur Milkshakes avec verre lexan.

DE Machines pour préparer simultanément plusieurs recettes. Corps en alliage d'aluminium léger verni - moteurs indépendants.  
**GP2SF:** composé d'une presse-fruits et d'un mélangeur avec verre lexan de 1,5 L  
**GP2FR:** composé d'un mixer avec verre lexan de 1,5 L et d'un brise-glace avec verre en acier Inox.  
**GP3SFF:** composé d'un presse-fruits à levier, d'un mixeur avec verre de 1,5 L en lexan et mixeur Milkshakes avec verre lexan.

ES Máquinas para varias preparaciones simultáneas. Estructura de aleación ligera de aluminio pintado - motores independientes.  
**GP2SF:** compuesto por exprimidor y batidora con vaso de 1,5 L de lexan.  
**GP2FR:** compuesto por batidora con vaso de 1,5 L de lexan y rompe hielo con vaso de acero inoxidable.  
**GP3SFF:** compuesto por exprimidor, batidora con vaso de 1,5 L de lexan y batidoras para batidos con vaso de lexan.

RU Машины для одновременного выполнения различных типов обработки. Окрашенный корпус из легкого алюминиевого сплава - независимые двигатели.  
**GP2SF:** состоит из соковыжималки для цитрусовых и блендера со стаканом объемом 1,5 л из лексана.  
**GP2FR:** состоит из блендера со стаканом объемом 1,5 л из лексана и льдодробителя со стаканом из нержавеющей стали.  
**GP3SFF:** состоит из соковыжималки для цитрусовых, блендера со стаканом объемом 1,5 л из лексана и прибор для приготовления фραπε со стаканом из лексана.

	GP2SF	GP2FR	GP3SFF
	0,15 + 0,35 kW		0,15 + 0,35 + 0,12 kW
	230V/1N/50-60Hz		
	500 - 16000 rpm	800 - 16000 rpm	500 - 16000 - 16000 rpm
	380 x 240 x 490(h) mm	380 x 300 x 490(h) mm	510 x 240 x 500(h) mm
			
	9 Kg		11 Kg
	10 Kg		12 Kg
	530 x 310 x 530(h) mm		
	0,087 m³		

# TOP3D TOP6D



TOP3D













TOP6D

Tostiere  
serie TOP

TOASTER  
GRILLE-PAIN  
TOASTER  
TOSTADORA  
TOCTEP



- IT** Macchina per riscaldare pizze, panini, cibi precotti, hamburger, würstel, toast farciti, piadine, ecc. Struttura in acciaio inox - funzionamento mediante resistenze con tubi al quarzo - timer 0÷15 minuti - capacità toast 3 (mod. TOP3D) e 6 (mod. TOP6D).
- EN** Machine to heat pizzas, sandwiches, precooked foods, hamburger, sausages, stuffed toast, piadine, etc. Stainless steel casing - quartz tube heating element operation - timer from 0 to 15 minutes - heating capacity of 3 toasts (mod. TOP3D) and 6 toasts (mod. TOP6D).
- FR** Machine pour chauffer les pizzas, les petits pains, les aliments pré-cuits, les steak hachés, les saucisses de Francfort, les toasts farcis, les piadine, etc. Corps en acier inox - fonctionnement par résistances à tubes au quartz - minuterie de 0 à 15 minutes - capacité de chauffe de 3 toasts (mod. TOP3D) et 6 (mod. TOP6D).
- DE** Maschine zum Erhitzen von Pizza, belegten Broten, vorgekochten Speisen, Würsten, gefüllten Toasts, Fladenbrot usw. Gehäuse aus Edelstahl - Betrieb mittels Widerstände mit Quarzrohren - Timer 0÷15 Minuten. Toastkapazität 3 (mod. TOP3D) und 6 (mod. TOP6D).
- ES** Máquina para calentar pizzas, bocadillos, alimentos pre-cocinados, hamburguesas, salchichas, tostadas, piadina (tortilla de pan ácimo), etc. Estructura de acero inoxidable - funcionamiento por medio de resistencias con tubos de cuarzo - temporizador 0÷15 minutos. Capacidad 3 tostadas (mod. TOP3D) e 6 (mod. TOP6D).
- RU** Машина для разогрева пиццы, сэндвичей, полуфабрикатов, гамбургеров, колбас, фаршированных тостов, пиадин и др. Корпус из нержавеющей стали - кварцевый трубчатый нагревательный элемент - таймер от 0 до 15 минут - мощность нагрева 3 тостов (модель TOP3D) и 6 тостов (модель TOP6D).

	TOP3D	TOP6D
	2,2 kW	3,3 kW
	230V/1N/50-60Hz	
	Meccanico - Mechanical - Механический 0÷15'	
	370 x 230 x 90(h) mm	370 x 230 x 180(h) mm
	490 x 250 x 230(h) mm	490 x 250 x 350(h) mm
		
	8 Kg	9,5 Kg
	10 Kg	11,5 Kg
	590 x 360 x 340(h) mm	590 x 370 x 490(h) mm
	0,073 m <sup>3</sup>	0,107 m <sup>3</sup>



TOC  
TOCS



TOC

Tostapane continuo

CONTINUOUS TOASTER  
GRILLE-PAIN CONTINU  
DURCHLAUF-TOASTER  
TOSTADORA DE PAN CONTINUA  
НЕПРЕРЫВНЫЙ ТОСТЕР

IT Macchina per tostare fette di pane a ciclo continuo. Struttura in acciaio inox - tappeto di tostatura girevole in acciaio inox - camera di cottura rivestita in materiale isolante - motore autoventilato con riduttore incorporato - regolazione velocità scorrimento tappeto di cottura - funzionamento mediante resistenze con tubi al quarzo - accensione tubi a blocchi per meglio impostare il calore desiderato - ventola di dissipazione calore.

EN Continuous bread slice toaster. Stainless steel casing - rotating stainless steel toasting mat - cooking chamber coated with insulating material - self-ventilating motor with built-in gear motor - toasting mat sliding speed adjustment - resistance function with quartz tubes - block tube power to better set required heat - heat dissipation fan.

FR Machine pour griller les tranches de pain en continu. Corps en acier inox - tapis de grillage rotatif en acier inox - chambre de cuisson revêtue de matériel isolant - moteur auto ventilé avec réducteur incorporé - réglage de vitesse à coulissement du tapis de cuisson - fonctionnement par résistances à tubes au quartz - mise en marche avec tubes à blocages pour mieux programmer la chaleur voulue - ventilateur de dissipation de chaleur.

DE Maschine zum Toasten von Brotscheiben im Dauerzyklus. Gehäuse aus Edelstahl - drehbare Toastfläche aus Inox-Stahl - Garkammer mit Isoliermaterialbeschichtung - Motor mit Eigenbelüftung und eingebautem Getriebe - Einstellung der Toastflächen-Laufgeschwindigkeit - Betrieb mittels Widerstände mit Quarzrohren - Blockeinschaltung der Rohre zur besseren Einstellung der gewünschten Hitze - Wärmeableitungsventilator.

ES Máquina para tostar rebanadas de pan en proceso continuo. Estructura de acero inoxidable - tapete giratorio de acero inoxidable para tostar - cámara de cocción revestida con material aislante - motor con autoventilado y reductor incorporado - regulación velocidad deslizamiento tapete de cocción - funcionamiento por medio de resistencias con tubos de cuarzo - encendido de tubos en bloques para regular el calor necesario - ventilador para disipar el calor.

RU Прибор для обжаривания хлеба в непрерывном режиме. Каркас из нержавеющей стали, поворотная обжарочная поверхность из нержавеющей стали, жарочная камера облицована изолирующим материалом, самовентилируемый двигатель со встроенным редуктором, регулировка скорости обжарочной поверхности, нагревательные элементы с кварцевыми трубками, поблочное включение трубок для оптимального задания температуры, вентилятор для распределения тепла.

	TOC	TOCS
	3 kW	2,6 kW
	230V/1N/50-60Hz	
	305 x 410 mm	220 x 330 mm
	150÷480 (n°)	80÷360 (n°)
	100÷360"	75÷270"
	450 x 680 x 390(h) mm	370 x 480 x 340(h) mm
		
	22 Kg	16 Kg
	25 Kg	18 Kg
	550 x 720 x 480(h) mm	420 x 560 x 450(h) mm
	0,190 m <sup>3</sup>	0,106 m <sup>3</sup>

PV27LL  
PV27LR



PV27LR



PV27LL

Piastra elettrica  
in vitroceramica

PYROCERAM GRILLS  
PLAQUE EN VITROCÉRAMIQUE  
GLASKERAMIKPLATTEN  
PLACAS DE VITROCERÁMICA  
СТЕКЛОКЕРАМИЧЕСКАЯ ПЛИТА

IT Macchina per cuocere e riscaldare carne, pesce, uova, verdura, formaggi, toast farciti, panini, ecc. Struttura in acciaio inox - piastra in vetroceramica tipo "eurokera" - resistenze ad infrarossi. Piastre superiori auto-bilanciate, lisce o rigate - piastra inferiore liscia, spessore 5 mm - isolamento termico in fibrocera mica - impianto elettrico in silicovetro - termostato di sicurezza.









EN The electric contact grill in glass ceramic are suitable to warm sandwiches up and to cook meat, fish, vegetables, etc.. Thanks to the utilisation of the infrared elements, they rapidly reach the temperature set. The stainless steel structure and the glass ceramic cooking surfaces by eurokera make the cleaning operation very easy. Auto-balanced upper surfaces, smooth or ribbed - smooth bottom surface, 5 mm thick - thermal insulation in ceramic-fibre - electrical system in silicon-glass - safety thermostat.

FR Les plaques électriques en vitrocéramique sont indiquées pour le chauffage de sandwichs et pour la cuisson de viande, poisson, légumes, etc.. Grâce à l'utilisation des éléments à infrarouge, elles peuvent rejoindre la température programmée rapidement. La structure en acier inox et les plaques de cuisson en vitrocéramique eurokera permettent un nettoyage très facile. Plaques supérieures auto-balançées, lisses ou rainurées - plaque inférieure lisse, épaisseur 5 mm - isolation thermique en fibre-céramique - installation électrique en vitre-silicone - thermostat de sécurité.

DE Die Elektroplatten aus Glaskeramik werden zum Rösten von Toastbrot und Brötchen und zum Kochen von Fleisch, Fisch, Gemüse, usw. verwendet. Dank dem Gebrauch von Infrarotheizelementen erreichen sie die eingestellte Temperatur äußerst schnell. Dank des Gehäuses aus Edelstahl und den Kochplatten aus Glaskeramik eurokera sind sie äußerst einfach zu reinigen. Glatte oder gestreifte selbstausgleichende obere Platten - Glatte untere Platte, Dicke 5 mm - Wärmeisolierung aus Keramikfaser - Elektroanlage aus Siliconglas - Sicherheitsthermostat.

ES Máquina para cocinar y calentar carne, pescados, huevos, verdura, queso, tostadas, bocadillos. Estructura de acero inoxidable - placas de cocción vitrocerámicas "eurokera" - resistencias de infrarrojos. Placas superiores auto-equilibradas, lisas o rayadas - placa inferior lisa, espesor 5 mm - aislamiento térmico de fibrocera mica - instalación eléctrica de vidrio siliconado - termostato de seguridad.

RU Электрические стеклокерамические плиты предназначены для быстрого разогревания тостового хлеба и бутербродов или приготовления мяса, рыбы, овощей и т.д. Они быстро достигают заданной температуры благодаря инфракрасным сопротивлениям. Корпус из нержавеющей стали и плиты из стеклокерамики eurokera способствуют быстрой очистке при уходе. Верхние плиты с автоматической балансировкой и гладкой или рифлёной жарочной поверхностью - гладкая нижняя плита толщиной 5 мм - теплоизоляция из фиброкерамики - электропроводка из стеклосиликона - предохранительный термостат.

	PV27LL	PV27LR
	1,7 kW	
 1 Ph	230V/1N/50-60Hz	
 mm	270 x 300 mm	
	Liscia-Liscia Smooth-Smooth Гладкий-Гладкий	Liscia-Rigata Smooth-Grooved Гладкий / Рифлёный
	50÷300°C	
 mm	340 x 450 x 190/600(h) mm	
		
 NET Kg	11,5 Kg	
 GROSS Kg	13,5 Kg	
 mm	430 x 540 x 270(h) mm	
 m <sup>3</sup>	0,062 m <sup>3</sup>	

\* La superficie di cottura inferiore è sempre liscia.  
The lower cooking surface is always smooth.  
La surface de cuisson inférieure est toujours lisse.  
Die untere Kochfläche ist immer glatt.  
La superficie de cocción inferior es siempre lisa.  
Нижняя варочная поверхность всегда гладкая.

# PV40LL PV40LR



PV40LR



PV40LL

Piastra elettrica  
in vetroceramica

PYROCERAM GRILLS  
PLAQUE EN VITROCÉRAMIQUE  
GLASKERAMIKPLATTEN  
PLACAS DE VITROCERÁMICA  
СТЕКЛОКЕРАМИЧЕСКАЯ ПЛИТА

IT Macchina per cuocere e riscaldare carne, pesce, uova, verdura, formaggi, toast farciti, panini, ecc. Struttura in acciaio inox - piastra in vetroceramica tipo "eurokera" - resistenze ad infrarossi. Piastre superiori auto-bilanciate, lisce o rigate - piastra inferiore liscia, spessore 5 mm - isolamento termico in fibrocera mica - impianto elettrico in silicovetro - termostato di sicurezza.

EN The electric contact grill in glass ceramic are suitable to warm sandwiches up and to cook meat, fish, vegetables, etc.. Thanks to the utilisation of the infrared elements, they rapidly reach the temperature set. The stainless steel structure and the glass ceramic cooking surfaces by eurokera make the cleaning operation very easy. Auto-balanced upper surfaces, smooth or ribbed - smooth bottom surface, 5 mm thick - thermal insulation in ceramic-fibre - electrical system in silicon-glass - safety thermostat.

FR Les plaques électriques en vitrocéramique sont indiquées pour le chauffage de sandwiches et pour la cuisson de viande, poisson, légumes, etc.. Grâce à l'utilisation des éléments à infrarouge, elles peuvent rejoindre la température programmée rapidement. La structure en acier inox et les plaques de cuisson en vitrocéramique eurokera permettent un nettoyage très facile. Plaques supérieures auto-balançées, lisses ou rainurées - plaque inférieure lisse, épaisseur 5 mm - isolation thermique en fibre-céramique - installation électrique en vitre-silicone - thermostat de sécurité.

DE Die Elektroplatten aus Glaskeramik werden zum Rösten von Toastbrot und Brötchen und zum Kochen von Fleisch, Fisch, Gemüse, usw. verwendet. Dank dem Gebrauch von Infrarotheizelementen erreichen sie die eingestellte Temperatur äußerst schnell. Dank des Gehäuse aus Edelstahl und den Kochplatten aus Glaskeramik eurokera sind sie äußerst einfach zu reinigen. Glatte oder gestreifte selbstausgleichende obere Platten - Glatte untere Platte, Dicke 5 mm - Wärmeisolierung aus Keramikfaser - Elektroanlage aus Siliconglas - Sicherheitsthermostat.

ES Máquina para cocinar y calentar carne, pescados, huevos, verdura, queso, tostadas, bocadillos. Estructura de acero inoxidable - placas de cocción vitrocerámicas "eurokera" - resistencias de infrarrojos. Placas superiores auto-equilibradas, lisas o rayadas - placa inferior lisa, espesor 5 mm - aislamiento térmico de fibrocera mica - instalación eléctrica de vidrio siliconado - termostato de seguridad.

RU Электрические стеклокерамические плиты предназначены для быстрого разогревания тостового хлеба и бутербродов или приготовления мяса, рыбы, овощей и т.д. Они быстро достигают заданной температуры благодаря инфракрасным сопротивлениям. Корпус из нержавеющей стали и плиты из стеклокерамики eurokera способствуют быстрой очистке при уходе. Верхние плиты с автоматической балансировкой и гладкой или рифлёной жарочной поверхностью - гладкая нижняя плита толщиной 5 мм - теплоизоляция из фиброкерамики - электропроводка из стеклосиликона - предохранительный термостат.

\* La superficie di cottura inferiore è sempre liscia.  
The lower cooking surface is always smooth.  
La surface de cuisson inférieure est toujours lisse.  
Die untere Kochfläche ist immer glatt.  
La superficie de cocción inferior es siempre lisa.  
Нижняя варочная поверхность всегда гладкая.

	PV40LL	PV40LR
		
	2 kW	
	230V/1N/50-60Hz	
	400 x 300 mm	
	Liscia-Liscia Smooth-Smooth Гладкий-Гладкий	Liscia-Rigata Smooth-Grooved Гладкий / Рифлёный
	50÷300°C	
	490 x 450 x 190/600(h) mm	
		
	15,5 Kg	
	17 Kg	
	530 x 580 x 360(h) mm	
	0,110 m <sup>3</sup>	



PV40LR

# PV55LL PV55LR



PV55LR



PV55LL

Piastra elettrica  
in vitroceramica

PYROCERAM GRILLS  
PLAQUE EN VITROCÉRAMIQUE  
GLASKERAMIKPLATTEN  
PLACAS DE VITROCERÁMICA  
СТЕКЛОКЕРАМИЧЕСКАЯ ПЛИТА



IT Macchina per cuocere e riscaldare carne, pesce, uova, verdura, formaggi, toast farciti, panini, ecc. Struttura in acciaio inox - piastra in vitroceramica tipo "eurokera" - resistenze ad infrarossi. Piastre superiori auto-bilanciate, lisce o rigate - piastra inferiore liscia, spessore 5 mm - isolamento termico in fibrocera mica - impianto elettrico in silicovetro - termostato di sicurezza.













EN The electric contact grill in glass ceramic are suitable to warm sandwiches up and to cook meat, fish, vegetables, etc.. Thanks to the utilisation of the infrared elements, they rapidly reach the temperature set. The stainless steel structure and the glass ceramic cooking surfaces by eurokera make the cleaning operation very easy. Auto-balanced upper surfaces, smooth or ribbed - smooth bottom surface, 5 mm thick - thermal insulation in ceramic-fibre - electrical system in silicon-glass - safety thermostat.

FR Les plaques électriques en vitrocéramique sont indiquées pour le chauffage de sandwiches et pour la cuisson de viande, poisson, légumes, etc.. Grâce à l'utilisation des éléments à infrarouge, elles peuvent rejoindre la température programmée rapidement. La structure en acier inox et les plaques de cuisson en vitrocéramique eurokera permettent un nettoyage très facile. Plaques supérieures auto-balançées, lisses ou rainurées - plaque inférieure lisse, épaisseur 5 mm - isolation thermique en fibre-céramique - installation électrique en vitre-silicone - thermostat de sécurité.

DE Die Elektroplatten aus Glaskeramik werden zum Rösten von Toastbrot und Brötchen und zum Kochen von Fleisch, Fisch, Gemüse, usw. verwendet. Dank dem Gebrauch von Infrarotheizelementen erreichen sie die eingestellte Temperatur äußerst schnell. Dank des Gehäuse aus Edelstahl und den Kochplatten aus Glaskeramik eurokera sind sie äußerst einfach zu reinigen. Glatte oder gestreifte selbstausgleichende obere Platten - Glatte untere Platte, Dicke 5 mm - Wärmeisolierung aus Keramikfaser - Elektroanlage aus Siliconglas - Sicherheitsthermostat.

ES Máquina para cocinar y calentar carne, pescados, huevos, verdura, queso, tostadas, bocadillos. Estructura de acero inoxidable - placas de cocción vitrocerámicas "eurokera" - resistencias de infrarrojos. Placas superiores auto-equilibradas, lisas o rayadas - placa inferior lisa, espesor 5 mm - aislamiento térmico de fibrocera mica - instalación eléctrica de vidrio siliconado - termostato de seguridad.

RU Электрические стеклокерамические плиты предназначены для быстрого разогревания тостового хлеба и бутербродов или приготовления мяса, рыбы, овощей и т.д. Они быстро достигают заданной температуры благодаря инфракрасным сопротивлениям. Корпус из нержавеющей стали и плиты из стеклокерамики eurokera способствуют быстрой очистке при уходе. Верхние плиты с автоматической балансировкой и гладкой или рифлёной жарочной поверхностью - гладкая нижняя плита толщиной 5 мм - теплоизоляция из фиброкерамики - электропроводка из стеклосиликона - предохранительный термостат.

	PV55LL	PV55LR
	3,4 kW	
	230-400V/3N/50-60Hz	
	230V/1N/50-60Hz	
	550 x 300 mm	
	Liscia-Liscia Smooth-Smooth Гладкий-Гладкий	Liscia-Rigata Smooth-Grooved Гладкий / Рифлёный
	50÷300°C	
	630 x 450 x 190/600(h) mm	
		
	23 Kg	
	32 Kg	
	730 x 530 x 410(h) mm	
	0,159 m <sup>3</sup>	

\* La superficie di cottura inferiore è sempre liscia.  
The lower cooking surface is always smooth.  
La surface de cuisson inférieure est toujours lisse.  
Die untere Kochfläche ist immer glatt.  
La superficie de cocción inferior es siempre lisa.  
Нижняя варочная поверхность всегда гладкая.

PE25NL  
PE25NR



PE25NL



Piastra elettrica  
in ghisa

CAST IRON ELECTRICAL GRILLS  
PLAQUES ELECTRIQUES EN FONTE  
GUSSEISENELEKTROPLATTEN  
PLACAS ELÉCTRICAS DE FUNDICIÓN  
ЭЛЕКТРИЧЕСКИЕ ПЛИТЫ

IT Macchina per cuocere e riscaldare carne, pesce, uova, verdura, formaggi, toast farciti, panini, ecc. Struttura in acciaio inox - piastra di cottura in ghisa sabbiata, in grado di mantenere a lungo la temperatura - resistenze a contatto con le piastre per garantire una migliore conducibilità - termostato di sicurezza - piastra superiore auto-bilanciata - disponibili con piano di cottura liscio o rigato.









EN Machine for cooking and heating meat, fish, eggs, vegetables, cheese, stuffed toast, sandwiches, etc. Stainless steel casing - sandblasted cast iron cooking plate, which maintains the temperature for a long time - heating elements placed directly on the plates to guarantee better conductivity - safety thermostat - self-balanced upper plate - available with smooth or ribbed cooking surface.

FR Machine pour cuire et chauffer la viande, le poisson, les oeufs, les légumes, les fromages, les toasts farcis, les petits pains, etc. Corps en acier inox - plaque de cuisson en fonte sablée, en mesure de conserver longtemps la température - résistances en contact avec les plaques pour garantir une meilleure conduction - thermostat de sécurité - plaque supérieure auto équilibrée - disponibles avec plan de cuisson lisse ou nervuré.

DE Maschine zum Garen und Erhitzen von Fleisch, Fisch, Eiern, Gemüse, Käse, gefüllten Toasts, Broten usw. Gehäuse aus Edelstahl - Kochplatte aus sandgestrahltem Gusseisen, geeignet zur langfristigen Beibehaltung der Temperatur - Heizelemente zur besseren Wärmeleitfähigkeit - Sicherheitsthermostat - obere selbsttätige ausbalancierte Platte - erhältlich mit glatter oder gerillter Kochfläche.

ES Máquina para cocinar y calentar carne, pescados, huevos, verdura, queso, tostadas, bocadillos. Estructura de acero inoxidable - placa de cocción de hierro fundido arenado, que permite mantener la temperatura - resistencias en contacto con las placas para la mejor conductibilidad - termostato de seguridad. Placa superior auto-equilibrada. Dìponible con plano de cocción liso o rayado.

RU Машина для приготовления и нагрева мяса, рыбы, яиц, овощей, сыра, фаршированных тостов, сэндвичей и т.д.. Конструкция из нержавеющей стали - чугунная варочная панель, подвергнутая пескоструйной обработке, способная поддерживать температуру в течение длительного времени - сопротивление контакту с варочной панелью для обеспечения лучшей проводимости - безопасный термостат - самобалансирующаяся верхняя панель - предлагается с гладкой или полосатой поверхностью.

	PE25NL	PE25NR
	1,8 kW	
 1 Ph	230V/1N/50-60Hz	
 mm	240 x 230 mm	
	Liscia-Rigata Smooth-Grooved Гладкий / Рифлёный	Rigata-Rigata Grooved-Grooved Рифлёный-Рифлёный
	50÷300°C	
 mm	320 x 360 x 200/520(h) mm	
		
 NET Kg	16 Kg	
 GROSS Kg	18 Kg	
 mm	450 x 460 x 300 (h) mm	
 m <sup>3</sup>	0,062 m <sup>3</sup>	

\* La superficie di cottura superiore è sempre rigata.  
The upper cooking surface is always ribbed.  
La surface de cuisson supérieure est toujours nervuré.  
Die obere Kochfläche ist immer gerillt.  
La superficie de cocción superior siempre es rayada.  
Верхняя варочная поверхность всегда рифлёная.

PE35NL  
PE35NR



PE35NR



PE35NL

Piastra elettrica  
in ghisa

CAST IRON ELECTRICAL GRILLS  
PLAQUES ELECTRIQUES EN FONTE  
GUSSEISENELEKTROPLATTEN  
PLACAS ELÉCTRICAS DE FUNDICIÓN  
ЭЛЕКТРИЧЕСКИЕ ПЛИТЫ

IT Macchina per cuocere e riscaldare carne, pesce, uova, verdura, formaggi, toast farciti, panini, ecc. Struttura in acciaio inox - piastra di cottura in ghisa sabbata, in grado di mantenere a lungo la temperatura - resistenze a contatto con le piastre per garantire una migliore conducibilità - termostato di sicurezza - piastra superiore auto-bilanciata - la superficie di cottura superiore rigata - disponibili con piano di cottura liscio o rigato.











EN Machine for cooking and heating meat, fish, eggs, vegetables, cheese, stuffed toast, sandwiches, etc. Stainless steel casing - sandblasted cast iron cooking plate, which maintains the temperature for a long time - heating elements placed directly on the plates to guarantee better conductivity - safety thermostat - self-balanced upper plate - ribbed upper cooking surface - available with smooth or ribbed cooking surface.

FR Machine pour cuire et chauffer la viande, le poisson, les oeufs, les légumes, les fromages, les toasts farcis, les petits pains, etc. Corps en acier inox - plaque de cuisson en fonte sablée, en mesure de conserver longtemps la température - résistances en contact avec les plaques pour garantir une meilleure conduction - thermostat de sécurité - plaque supérieure auto équilibrée - la surface de cuisson supérieure est toujours nervuré - disponibles avec plan de cuisson lisse ou nervuré.

DE Maschine zum Garen und Erhitzen von Fleisch, Fisch, Eiern, Gemüse, Käse, gefüllten Toasts, Broten usw. Gehäuse aus Edelstahl - Kochplatte aus sandgestrahltem Gusseisen, geeignet zur langfristigen Beibehaltung der Temperatur - Heizelemente zur besseren Wärmeleitfähigkeit - Sicherheitsthermostat - obere selbsttätige ausbalancierte Platte - Die obere Kochfläche ist immer gerillt - erhältlich mit glatter oder gerillter Kochfläche.

ES Máquina para cocinar y calentar carne, pescados, huevos, verdura, queso, tostadas, bocadillos. Estructura de acero inoxidable - placa de cocción de hierro fundido arenado, que permite mantener la temperatura - resistencias en contacto con las placas para la mejor conductibilidad - termostato de seguridad. Placa superior auto-equilibrada rayada. Diponible con plano de cocción liso o rayado.

RU Прибор для приготовления и разогревания мяса, рыбы, овощей - сыров, сэндвичей - бутербродов и т.п. Корпус из нержавеющей стали - жарочная плита из чугуна с пескоструйной обработкой - которая способна сохранять тепло в течение длительного времени - нагревательные элементы - контактирующие с плитами для обеспечения лучшей проводимости - предохранительный термостат- верхняя плита с автоматической балансировкой - жарочная плита предлагается гладкой или рифленой.

	PE35NL	PE35NR
	2,2 kW	
 1 Ph	230V/1N/50-60Hz	
 mm	340 x 230 mm	
	Liscia-Rigata Smooth-Grooved Гладкий / Рифлёный	Rigata-Rigata Grooved-Grooved Рифлёный-Рифлёный
	50±300°C	
 mm	420 x 360 x 200/520(h) mm	
		
 NET Kg	22 Kg	
 GROSS Kg	24 Kg	
 mm	560 x 470 x 300(h) mm	
 m <sup>3</sup>	0,079 m <sup>3</sup>	

\* La superficie di cottura superiore è sempre rigata.  
The upper cooking surface is always ribbed.  
La surface de cuisson supérieure est toujours nervuré.  
Die obere Kochfläche ist immer gerillt.  
La superficie de cocción superior siempre es rayada.  
Верхняя варочная поверхность всегда рифлёная.

# PE50NL



# PE50NM



# PE50NR



Piastra elettrica  
in ghisa

CAST IRON ELECTRICAL GRILLS  
PLAQUES ELECTRIQUES EN FONTE  
GUSSEISENELEKTROPLATTEN  
PLACAS ELÉCTRICAS DE FUNDICIÓN  
ЭЛЕКТРИЧЕСКИЕ ПЛИТЫ

IT Macchina per cuocere e riscaldare carne, pesce, uova, verdura, formaggi, toast farciti, panini, ecc. Struttura in acciaio inox - piastra di cottura in ghisa sabbata, in grado di mantenere a lungo la temperatura - resistenze a contatto con le piastre per garantire una migliore conducibilità - termostato di sicurezza - piastra superiore auto-bilanciata - disponibili con piano di cottura liscio, rigato o misto.













EN Machine for cooking and heating meat, fish, eggs, vegetables, cheese, stuffed toast, sandwiches, etc. Stainless steel casing - sandblasted cast iron cooking plate, which maintains the temperature for a long time - heating elements placed directly on the plates to guarantee better conductivity - safety thermostat - self-balanced upper plate - available with smooth, ribbed or mixed cooking surface.

FR Machine pour cuire et chauffer la viande, le poisson, les œufs, les légumes, les fromages, les toasts farcis, les petits pains, etc. Corps en acier inox - plaque de cuisson en fonte sablée, en mesure de conserver longtemps la température - résistances en contact avec les plaques pour garantir une meilleure conduction - thermostat de sécurité - plaque supérieure auto équilibrée - disponibles avec plan de cuisson lisse, nervuré ou mixte.

DE Maschine zum Garen und Erhitzen von Fleisch, Fisch, Eiern, Gemüse, Käse, gefüllten Toasts, Broten usw. Gehäuse aus Edelstahl - Kochplatte aus sandgestrahltem Gusseisen, geeignet zur langfristigen Beibehaltung der Temperatur - Heizelemente zur besseren Wärmeleitfähigkeit - Sicherheitsthermostat - obere selbsttätige ausbalancierte Platte - erhältlich mit glatter, gerillter oder Kombi Kochfläche.

ES Máquina para cocinar y calentar carne, pescados, huevos, verdura, queso, tostadas, bocadillos. Estructura de acero inoxidable - placa de cocción de hierro fundido arenado, que permite mantener la temperatura - resistencias en contacto con las placas para la mejor conductibilidad - termostato de seguridad. Placa superior auto-equilibrada rayada. Diponible con plano de cocción liso o rayado.

RU Прибор для приготовления и разогревания мяса, рыбы, овощей - сыров, сэндвичей - бутербродов и т.п. Корпус из нержавеющей стали - жарочная плита из чугуна с пескоструйной обработкой - которая способна сохранять тепло в течение длительного времени - нагревательные элементы - контактирующие с плитами для обеспечения лучшей проводимости - предохранительный термостат- верхняя плита с автоматической балансировкой - жарочная плита предлагается гладкой, рифленой или комбинированной.

	PE50NL	PE50NR	PE50NM
	3,6 kW		
	400V/3N/50-60Hz		
	230V/1N/50-60Hz		
	480 x 230 mm		
	Liscia-Rigata Smooth-Grooved Гладкий-Рифлёный	Rigata-Rigata Grooved-Grooved Рифлёный- Рифлёный	Mista-Rigata Mixed-Grooved Смешанный- Рифлёный
	50÷300°C		
	570 x 360 x 200/520(h) mm		
			
	27 Kg		
	34 Kg		
	690 x 450 x 380(h) mm		
	0,118 m <sup>3</sup>		

\* La superficie di cottura superiore è sempre rigata.  
The upper cooking surface is always ribbed.  
La surface de cuisson supérieure est toujours nervuré.  
Die obere Kochfläche ist immer gerillt.  
La superficie de cocción superior siempre es rayada.  
Верхняя варочная поверхность всегда рифлёная.

# CRPN CRP2N



CRPN



CRP2N

Crepiere  
elettriche

ELECTRIC CRÊPES MACHINES  
CRÊPIÈRES ÉLECTRIQUES  
ELEKTRISCHE CRÊPES-MASCHINEN  
MÁQUINA PARA CREPES ELÉCTRICA  
ЭЛЕКТРИЧЕСКИЕ - ГАЗОВЫЕ БЛИННИЦЫ



- IT** Macchine per la preparazione di crepes dolci o salate. Struttura in acciaio inox - piastra di cottura in ghisa con superficie multirighe antiscivolo - disponibili con una o due piastre di cottura - tempo di cottura da 1 a 3' circa - termostato per la regolazione temperatura su ogni piastra - piastre doppie con funzionamento indipendente.
- EN** Machines for the preparation of sweet or savoury crepes. Stainless steel casing - cast iron cooking plate with non-slip multi-line surface - available with one or two cooking plates - cooking time from about 1 to 3' - thermostat for the temperature regulation on each plate - double plates with independent operation.
- FR** Corps en acier inox - plaque de cuisson en fonte avec surface à plusieurs nervures antidérapante - disponibles avec une ou deux plaques de cuisson - temps de cuisson d'environ 1 à 3 minutes - thermostat de réglage de température sur chaque plaque - plaques doubles avec fonctionnement indépendant.
- DE** Gehäuse aus Edelstahl. Kochplatte aus Gusseisen mit rutschfester Mehrfachrillenoberfläche - erhältlich mit einer oder zwei Kochplatten - Garzeit von ca. 1 bis 3' - Thermostat zur Einstellung der Temperatur auf jeder Platte - Doppelplatten mit unabhängigem Betrieb.
- ES** Máquina para preparar crepes dulces o saladas. Estructura de acero inoxidable - placa de cocción de fundición con superficie multirayada antideslizante - disponible con una o dos placas de cocción - tiempo de cocción de 1 a 3 minutos - termostato para la regulación de la temperatura de cada placa - placas dobles con funcionamiento independiente.
- RU** Корпус из нержавеющей стали, жарочная поверхность из чугуна с пескоструйной обработкой с насечками против скольжения, в исполнении с одной или двумя жарочными поверхностями, время приготовления от 1 до 3 футов - термостат для регулировки температуры каждой жарочной поверхности, две независимо работающие жарочные поверхности.

	CRPN	CRP2N
	2,4 kW	2,4 + 2,4 kW
	-	400V/3N/50-60Hz
	230V/1N/50-60Hz	-
	ø 350 mm	ø 350 mm x 2
	50÷300°C	
	370 x 370 x 140(h) mm	760 x 370 x 140(h) mm
		
	12 Kg	23 Kg
	14 Kg	25 Kg
	500 x 430 x 214(h) mm	810 x 430 x 214(h) mm
	0,046 m³	0,074 m³

CRP4  
CRP42



CRP42

Crepiere  
elettriche

ELECTRIC CRÊPES MACHINES  
CRÊPIÈRES ÉLECTRIQUES  
ELEKTRISCHE CRÊPES-MASCHINEN  
MÁQUINA PARA CREPES ELÉCTRICA  
ЭЛЕКТРИЧЕСКИЕ - ГАЗОВЫЕ БЛИННИЦЫ

- IT** Macchine per la preparazione di crepes dolci o salate. Struttura in acciaio inox - piastra di cottura in ghisa con superficie multirighe antiscivolo - disponibili con una o due piastre di cottura - tempo di cottura da 1 a 3' circa - termostato per la regolazione temperatura su ogni piastra - piastre doppie con funzionamento indipendente.
- EN** Machines for the preparation of sweet or savoury crepes. Stainless steel casing - cast iron cooking plate with non-slip multi-line surface - available with one or two cooking plates - cooking time from about 1 to 3' - thermostat for the temperature regulation on each plate - double plates with independent operation.
- FR** Corps en acier inox - plaque de cuisson en fonte avec surface à plusieurs nervures antidérapante - disponibles avec une ou deux plaques de cuisson - temps de cuisson d'environ 1 à 3 minutes - thermostat de réglage de température sur chaque plaque - plaques doubles avec fonctionnement indépendant.
- DE** Gehäuse aus Edelstahl. Kochplatte aus Gusseisen mit rutschfester Mehrfachrillenoberfläche - erhältlich mit einer oder zwei Kochplatten - Garzeit von ca. 1 bis 3' - Thermostat zur Einstellung der Temperatur auf jeder Platte - Doppelplatten mit unabhängigem Betrieb.
- ES** Máquina para preparar crepes dulces o saladas. Estructura de acero inoxidable - placa de cocción de fundición con superficie multirayada antideslizante - disponible con una o dos placas de cocción - tiempo de cocción de 1 a 3 minutos - termostato para la regulación de la temperatura de cada placa - placas dobles con funcionamiento independiente.
- RU** Корпус из нержавеющей стали, жарочная поверхность из чугуна с пескоструйной обработкой с насечками против скольжения, в исполнении с одной или двумя жарочными поверхностями, время приготовления от 1 до 3 футов - термостат для регулировки температуры каждой жарочной поверхности, две независимо работающие жарочные поверхности.

	<b>CRP4</b>	<b>CRP42</b>
	2,75 kW	2,75 + 2,75 kW
	-	400V/3N/50-60Hz
	230V/1N/50-60Hz	-
	ø 400 mm	ø 400 mm x 2
	50÷300°C	
	400 x 470 x 120(h) mm	810 x 470 x 120(h) mm
		
	16 Kg	29 Kg
	18 Kg	35 Kg
	530 x 580 x 230(h) mm	960 x 540 x 360(h) mm
	0,070 m³	0,187 m³

# CR400G1 CR400G2



CR400G1



CR400G2

## Crepiere a gas

GAS CRÊPES MACHINES  
CRÊPIÈRES À GAZ  
GAS CRÊPES-MASCHINEN  
MÁQUINA PARA CREPES DE GAS  
ГАЗОВЫЕ БЛИННИЦЫ

IT Macchine per la preparazione di crepes dolci o salate. Struttura in acciaio inox - piastra di cottura in ghisa con superficie multirighe antiscivolo - disponibili con una o due piastre di cottura - alimentazione a GPL, in dotazione kit metano - regolatore potenza fiamma con otto posizioni - accensione con piezoelettrico - piedini regolabili - piastre doppie con funzionamento indipendente- temperatura di cottura da 1 a 3' circa - allacciamento gas standard 1/2"G.















EN Machines for the preparation of sweet or savoury crepes. Stainless steel casing - cast iron cooking plate with non-slip multi-line surface - available with one or two cooking plates - LPG power supply, supplied with natural gas set - eight position flame power regulator - piezoelectric ignition - adjustable feet - double hobs with independent operation - cooking time from approx. 1 to 3' - standard gas connection 1/2"G.

FR Corps en acier inox - plaque de cuisson en fonte avec surface à plusieurs nervures antidérapante - disponibles avec une ou deux plaques de cuisson - Alimentation GPL, fournie avec kit gaz naturel - Régulateur de puissance de flamme à huit positions - allumage avec piézoélectrique - pieds réglables - tables de cuisson doubles avec fonctionnement indépendant - temps de cuisson d'env. 1 à 3' - raccordement gaz standard 1/2"G.

DE Gehäuse aus Edelstahl. Kochplatte aus Gusseisen mit rutschfester Mehrfachrillenoberfläche - erhältlich mit einer oder zwei Kochplatten - LPG-Versorgung, geliefert mit Erdgas-Kit - Flammenleistungsregler mit acht Positionen - Zündung mit Piezoelektrik - verstellbare Füße - Doppelkochfelder mit unabhängiger Bedienung - Garzeit von ca. 1 bis 3' - Standard-Gasanschluss 1/2"G.

ES Máquina para preparar crepes dulces o saladas. Estructura de acero inoxidable - placa de cocción de fundición con superficie multirayada antideslizante - disponible con una o dos placas de cocción - alimentación con GPL, en la dotación kit para metano - regulador de la potencia de la llama con ocho opciones - encendido piezoeléctrico - pies regulables - placas dobles con funcionamiento independiente - temperatura de cocción de 1 a 3 minutos - conexión gas estándar 1/2"G.

RU Машины для приготовления сладких или соленых блинчиков. Корпус из нержавеющей стали, жарочная поверхность из чугуна с пескоструйной обработкой с насечками против скольжения, в исполнении с одной или двумя жарочными поверхностями, работа на сжиженном природном газе, в комплекте с оснасткой для работы на метане, 8-позиционный регулятор интенсивности пламени, пьезоэлектрическое зажигание, регулируемые ножки, две независимо работающие жарочные поверхности - температура приготовления приibl. от 1 до 3' - стандартное газовое соединение 1/2"G.

	CR400G1	CR400G2
	3,6 kW	3,6 + 3,6 kW
	50±280°C	
	3600 kcal/h 14286 BTU/h	3600 + 3600 kcal/h 14286 + 14286 BTU/h
	G20 = 0,34 m³/h G25 = 0,41 m³/h	G20 = 0,34 + 0,34 m³/h G25 = 0,41 + 0,41 m³/h
	G30/G31 = 0,23 Kg/h	G30/G31 = 0,23 + 0,23 Kg/h
	N° 1 (Bruciatori - Burners - Горелки)	N° 2 (Bruciatori - Burners - Горелки)
	N° 1 (Piezoelettrico - Piezoelectric Пьезоэлектрический)	N° 2 (Piezoelettrico - Piezoelectric Пьезоэлектрический)
	ø 400 mm	ø 400 mm x 2
	480 x 480 x 270(h) mm	900 x 480 x 270(h) mm
		
	23 Kg	46 Kg
	26 Kg	52 Kg
	530 x 530 x 330(h) mm	960 x 540 x 450(h) mm
	0,093 m³	0,233 m³

WD3



Cuoci Hot Dog

HOT DOG  
PERRITO CALIENTE  
АППАРАТ ДЛЯ ПРИГОТОВЛЕНИЯ ХОТ-ДОГОВ

IT Macchine per riscaldare wurstel e cuocere panini. Struttura in acciaio inox - tre punzoni per riscaldare il pane - termostato 30÷90°C - campana in vetro con all'interno cestello inox per cottura würstel a bagno maria.

EN Machines for heating sausages and cooking hot dog buns. Stainless steel casing - three buns heating plots - thermostat from 30 to 90°C - glass cylinder with internal stainless steel bowl to heat sausages in a water bath.

FR Machine pour le chauffage de saucisses et la cuisson de petits pains. Corps en acier inoxydable - trois broches pour chauffer le pain - thermostat de 30 à 90°C - cylindre en verre avec bac interne en acier inoxydable pour chauffer les saucisses au bain marie.

DE Maschine zum Erhitzen von Würstchen und Brötchen. Gehäuse aus Edelstahl - drei Heizstiften zum Erwärmen des Brotes - Thermostat von 30 bis 90°C - Glaszylinder mit innenliegender Edelstahlwanne fürs Heizen von Würsten im Wasserbad.

ES Máquina para calentar salchichas y cocinar pan. Estructura de acero inoxidable - tres punzones para calentar el pan - termostato 30÷90 °C - campana de vidrio con cesta interna de acero inoxidable para calentar salchichas en baño maría.

RU Прибор для разогревания и приготовления булочек и сосисок. Корпус из нержавеющей стали, три штыря для разогревания булочек, термостат на 30÷90°C, стеклянный колпак, внутри которого помещена корзинка из нержавеющей стали для приготовления сосисок на пару.



	<b>WD3</b>
	1,1 kW
 1 Ph	230V/1N/50-60Hz
	30÷90°C
	480 x 300 x 350(h) mm
	
 NET Kg	10 Kg
 GROSS Kg	11 Kg
 mm	540 x 350 x 380(h) mm
 m <sup>3</sup>	0,072 m <sup>3</sup>



RW8

**FUORI  
PRODUZIONE  
OUT OF PRODUCTION**



Cuoci Hot Dog

HOT DOG  
PERRITO CALIENTE  
АППАРАТ ДЛЯ ПРИГОТОВЛЕНИЯ ХОТ-ДОГОВ



IT Macchina per riscaldare e cuocere wurstel e salsicce - cottura rapida ed uniforme che conferisce ai prodotti il sapore e la colorazione tipica della cottura alla griglia senza che sia necessario rigirarli manualmente - carcassa in acciaio inox - rulli in acciaio inox AISI 304 - resistenze elettriche corazzate poste all'interno dei rulli - cassetto raccolta residui di cottura - 3 livelli di potenza - 8 rulli di ø 25 mm con possibilità di cottura fino ad un massimo di 14 Wurstel.











EN Hot dog and sausage heating and cooking machine - fast and even cooking that confers products the flavour and colour typical of grilling with no need for manual intervention - stainless steel casing - AISI 304 stainless steel rollers - reinforced electric heating elements inside the rollers - cooking residue drip tray - 3 cooking power levels - 8 rollers ø 25 mm to cook up to a maximum of 14 sausages.

FR Appareil de chauffage et de cuisson pour different saucisses - cuisson rapide et uniforme qui donne aux produits la saveur et la couleur typiques du grillage sans intervention manuelle - corps en acier inox - rouleaux en acier inox AISI 304 - résistances électriques blindées dans les rouleaux - tiroir de collecte des résidus de cuisson - 3 puissances - 8 rouleaux ø 25 mm avec possibilité de cuire jusqu'à un maximum de 14 saucissons.

DE Maschine zum Erwärmen und Garen verschiedener Würstchen - schnelles und gleichmäßiges Garen, um den Produkten den typischen Geschmack und die typische Farbe des Grillens ohne manuelles Eingreifen zu verleihen - Edelstahlgehäuse - Rollen aus Edelstahl AISI 304 - verstärkte elektrische Heizstäbe in den Rollen - Schublade zum Sammeln von Garrückständen - 3 Leistungsstufen - 8 Rollen mit einem ø von 25 mm für das Kochen von bis zu maximal 14 Würstchen.

ES Máquina para calentar y cocinar perritos calientes y salchichas - cocción rápida y uniforme que confiere a los productos el sabor y la coloración típica de la cocción en parrilla sin necesidad de dar la vuelta manualmente - carcasa de acero inoxidable - rodillos de acero inoxidable AISI 304 - resistencias eléctricas blindadas colocadas dentro de los rodillos - cajón de recolección de los residuos de la cocción - 3 niveles de potencia de cocción. 8 rodillos de ø 25 mm. Capacidad hasta 14 salchichas.

RU Машина для нагрева и выпечки колбас и колбас - быстрая и равномерная выпечка, придающая продуктам вкус и цвет, характерные для приготовления на гриле. без необходимости поворачивать их вручную - корпус из нержавеющей стали - валики из нержавеющей стали AISI 304 - бронированные электрические сопротивления внутри валиков - ящик для сбора остатков пищи - 3 уровня мощности - 8 валиков диаметром 25 мм с возможностью приготовления до 14 колбас.

	<b>RW8</b>
	1,8 kW
 1 Ph	230V/1N/50-60Hz
	ø 25 mm - 350 mm
 mm	460 x 350 x 200(h) mm
	
 NET Kg	11 Kg
 GROSS Kg	12 Kg
 mm	590 x 440 x 270(h) mm
 m <sup>3</sup>	0,070 m <sup>3</sup>

**FUORI  
PRODUZIONE  
OUT OF PRODUCTION**

# PGEL



## Pressagelato

ICE CREAM PRESS  
PRESSE-GLACE  
EISPRESSE  
PRENSADOR PARA HELADO  
ПРЕСС ДЛЯ МОРОЖЕНОГО

IT Macchina per pressare il gelato in grado di ottenere diversi tipi di forme come spaghetti, tagliatelle o asparagi grazie all'utilizzo di diversi bicchieri. Struttura in alluminio - bicchiere in lega speciale anodizzata - dotato di bicchiere per spaghetti.

Optional: bicchiere tagliatelle e bicchiere asparagi.

EN Manual small press to make ice-cream spaghetti, tagliatelle or asparagus using different cups. Aluminium casing - special anodized alloy cup - equipped with spaghetti cup.

Optional: tagliatelle and asparagus cup.

FR Petite presse manuelle qui permet d'obtenir des spaghettis, des tagliatelles ou des asperges de glace à l'aide de différents récipients. Corps en aluminium - verre en alliage spécial anodisé - muni de verres pour spaghetti.

Accessoire: verre à tagliatelle et verre à asperges.

DE Kleine manuelle Presse zur Herstellung von Spaghetti-, Tagliatelle- oder Spargeleis durch verschiedene Bechern. Aluminiumgehäuse - spezieller eloxierter Aluminiumbecher - ausgestattet mit Spaghettibecher.







Zubehör: Tagliatelle und Spargelbecher.

ES Pequeño prensador manual para moldear el helado y obtener fideos, tallarines o espárragos de helado, dependiendo del vaso que se usa. Estructura de aluminio - vaso de aleación especial anodizada - Vaso para fideos.

Accesorios: Vaso para tallarines y vaso para espárragos.

RU Небольшой ручной пресс при помощи которого, используя различные стаканы, можно получать мороженое различных форм типа "спагетти", "лапша" или "спаржа". Алюминиевый каркас, стакан из специального сплава с анодированием, оснащен стаканом для "спагетти".

Аксессуары: стакан для мороженого типа "лапша" и стакан для мороженого типа "спаржа".

	<b>PGEL</b>
	205 x 245 x 520(h) mm
	
	3 Kg
	4 Kg
	230 x 220 x 520(h) mm
	0,026 m <sup>3</sup>





# Lavaggio

WASH  
LAVER  
WASCHEN  
СТИРАТЬ

## IT

Fimar Group a completamento della sua gamma di macchinari per la ristorazione introduce una piccola sezione dedicata al lavaggio dove è possibile trovare: lavastoviglie, lavabicchieri, cestelli ed accessori vari per offrire un servizio completo ai nostri clienti.

Consigliamo inoltre un assortimento di sgrassatori, detergenti e sanificatori per la ristorazione professionale che aiuteranno a mantenere al meglio i nostri macchinari.

## EN

To complete its range of catering equipment, Fimar Group has introduced a small section dedicated to washing where you will find: dishwashers, glasswashers, baskets and a variety of accessories to offer a complete service to our customers.

We also recommend an extensive assortment of degreasers, detergents and sanitisers for professional catering that will help maintain our machinery at its best.

## FR

Pour compléter sa gamme de machines pour la restauration, Fimar Group propose une petite section dédiée au lavage où vous trouverez : des lave-vaisselle, des lave-verres, des paniers et divers accessoires pour offrir un service complet à nos clients.

Nous recommandons également un assortiment de dégraissants, de détergents et d'assainisseurs pour la restauration professionnelle qui aideront à maintenir nos machines à leur meilleur niveau.

## DE

Zur Vervollständigung des Angebots an Catering-Maschinen führt die Fimar-Gruppe einen kleinen Bereich ein, der dem Spülen gewidmet ist und in dem Sie Geschirrspüler, Gläser-spüler, Körbe und zahlreiches Zubehör finden, um unseren Kunden einen kompletten Service zu bieten.

Wir empfehlen auch ein Sortiment an Entfettungsmitteln, Reinigungsmitteln und Desinfektionsmitteln für die professionelle Gastronomie, die dazu beitragen, unsere Maschinen optimal zu pflegen.

## ES

Para completar su gama de maquinaria de hostelería, Fimar Group introduce una breve sección dedicada al lavado donde podrá encontrar: lavavajillas, lavavasos, cestas y todo tipo de accesorios para ofrecer un servicio completo a nuestros clientes.

También recomendamos un surtido de desengrasantes, detergentes e higienizantes para hostelería profesional que ayudarán a mantener nuestra maquinaria en las mejores condiciones.

## RU

Fimar Group расширяет свой ассортимент оборудования для ресторанного бизнеса и представляет небольшой раздел по мойке, где вы найдете посудомоечные машины, моечные машины для стекол, корзины и разнообразные аксессуары, чтобы предоставить полный спектр услуг нашим клиентам.

Мы также рекомендуем ассортимент моющих средств, моющих средств и средств для дезинфекции для профессионального ресторанного бизнеса, которые помогут поддерживать наши машины в отличном состоянии.

# LABI35 LABI35PL

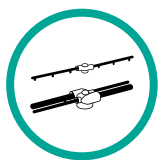

UP/DOWN



MAX H.250 MM

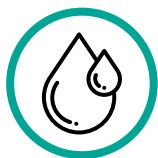

CARICO/SCARICO ACQUA  
WATER INLET/DRAIN



LABI35



Lavabicchieri  
cesto quadrato 35x35 cm

GLASSWASHER  
LAVE-VERRES  
GLÄSERSPÜLMASCHINE  
LAVAVASOS  
ПОСУДОМОЕЧНАЯ МАШИНА

IT Struttura a singola parete in acciaio inox **AISI 304**, vasca stampata con angoli arrotondati, porta a doppia parete - bracci di lavaggio e risciacquo in materiale composito facilmente smontabili - microinterruttore su porta - altezza utile lavaggio **25 cm** - dosatore di brillantante - riempimento automatico - risciacquo a caldo - funzione Thermostop - valvola antiriflusso di serie. In dotazione: 1 cesto bicchieri 35x35 cm - 1 cesto porta cucchiaini - 1 tubo di carico acqua (lunghezza 2 m) - 1 tubo di scarico (lunghezza 2,5 m).

















EN Mono skin structure made of stainless steel **AISI 304**, preshaped tank with rounded corners, double skinned door - easily removable wash and rins arms made of composite material - door microswitch - useful washing height **25 cm** - rinse aid dispenser - automatic filling - hot rinsing - Thermostop function - anti-backflow valve as standard. Supplied with: 1 glass basket 35x35 cm - 1 spoon basket - 1 water inlet hose (length 2 m) - 1 drain hose (length 2,5 m).

FR Carrosserie à simple paroi en acier inox **AISI 304**, cuve de lavage emboutie avec coins arrondis, porte à double parois - bras de lavage et rinçage en matériau composite facilement amovibles - microrupteur sur la porte - hauteur utile de lavage **25 cm** - doseur de produit de rinçage - remplissage automatique - rinçage à chaud - fonction Thermostop - soupape anti-retour de série. Livré avec: 1 panier à verres 35x35 cm - 1 panier à cuillères - 1 tuyau de chargement d'eau (longueur 2 m) - 1 tuyau de vidange (longueur 2,5 m).

DE Einwandiges Gehäuse aus Edelstahl **AISI 304**, vorgeformte Wanne mit abgerundeten Ecken, doppelwandige Tür - Wasch- und Spülarms aus leicht abnehmbarem Verbundwerkstoff - Tür mit Mikroschalter - nutzbare Waschhöhe **25 cm** - Klarspülerspender - automatische Befüllung - Heißspülung - Thermostop-Funktion - Rücklaufventil als Standard. Im Lieferumfang enthalten: 1 Glaskorb 35x35 cm - 1 Löffelkorb - 1 Wasserzulaufschlauch (Länge 2 m) - 1 Abflussschlauch (Länge 2,5 m).

ES Carrocería de simple pared de acero inoxidable **AISI 304**, cuba embutida con esquinas redondeadas, puerta de doble pared - brazos de lavado y aclarado de material compuesto fácilmente desmontables - microinterruptor en la puerta - altura útil de lavado **25 cm** - dosificador de abrillantador - llenado automático - aclarado con agua caliente - función Thermostop - válvula antiretorno de serie. Equipado con: 1 cesto vasos 35x35 cm - 1 cestillo cucharillas - 1 tubo de entrada de agua (longitud 2 m) - 1 tubo de desagüe (longitud 2,5 m).

RU Однослойная конструкция из нержавеющей стали **AISI 304**, бак с закругленными углами - бак предварительной формы с закругленными углами, формованные направляющие для корзин - дверца с двойной обшивкой - легко снимаемые рукоятки для мытья и ополаскивания из композитного материала - микровыключатель на двери - полезная высота мойки **25 см** - дозатор ополаскивателя - автомат наполнение - горячее ополаскивание - функция "Термостоп" - стандартный обратный клапан - поверхностный фильтр из нержавеющей стали. В комплекте: 1 стеклянная корзина 35x35 см - 1 корзина для ложек - 1 наливной шланг (длина 2 м) - 1 сливной шланг (длина 2,5 м).

	LABI35	LABI35PL*
		2,89 kW
 1 Ph		230V/50Hz
		0,19 kW
 h/N.		120" ciclo / cycle 30 cesti all'ora / baskets per hour
		10 L
		2 L
		2,7 kW
		3 L
		2,4 kW
		440 x 497 x 640(h) mm
		
		33,5 Kg
		39 Kg
		530 x 590 x 790(h) mm
		0,25 m <sup>3</sup>

\* Con dosatore di detersivo elettrico e pompa di scarico  
With electric detergent dispenser and drain pump  
Дополнительно оснащена электрическим дозатором  
моющих средств и сливным насосом

OPTIONAL



# LABI40 LABI40PL

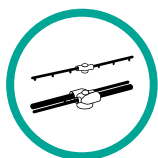

UP/DOWN



MAX H.300 MM

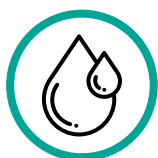

CARICO/SCARICO ACQUA  
WATER INLET/DRAIN



LABI40



Lavabicchieri  
cesto quadrato 40x40 cm

GLASSWASHER  
LAVE-VERRES  
GLÄSERSPÜLMASCHINE  
LAVAVASOS  
ПОСУДОМОЕЧНАЯ МАШИНА



IT Struttura a doppia parete parziale in acciaio inox **AISI 304**, vasca stampata con angoli arrotondati, correntini guida cesto stampati - porta a doppia parete - bracci di lavaggio e risciacquo in materiale composito facilmente smontabili - microinterruttore su porta - altezza utile lavaggio **30 cm** - Dosatore di brillantante - riempimento automatico - risciacquo a caldo - funzione Thermostop - valvola antiriflusso di serie. In dotazione: 1 cesto bicchieri 40x40 cm - 1 cesto porta cucchiaini - 1 tubo di carico acqua (lunghezza 2 m) - 1 tubo di scarico (lunghezza 2,5 m).

















EN Partial double skinned structure made of stainless steel **AISI 304**, preshaped tank with rounded corners, moulded basket guide rails - double skinned door - easily removable wash and rins arms made of composite material - door microswitch - useful washing height **30 cm** - Rinse aid dispenser - automatic filling - hot rinsing - Thermostop function - anti-backflow valve as standard. Supplied with: 1 glass basket 40x40 cm - 1 spoon basket - 1 water inlet hose (length 2 m) - 1 drain hose (length 2,5 m).

FR Carrosserie à double paroi partiel en acier inox **AISI 304**, cuve de lavage emboutie avec coins arrondis, supports panier imprimés, porte à double parois - bras de lavage et rinçage en matériau composite facilement amovibles - microrupteur sur la porte - hauteur utile de lavage **30 cm** - Doseur de produit de rinçage - remplissage automatique - rinçage à chaud - fonction Thermostop - soupape anti-retour de série. Livré avec: 1 panier à verres 40x40 cm - 1 panier à cuillères - 1 tuyau de chargement d'eau (longueur 2 m) - 1 tuyau de vidange (longueur 2,5 m).

DE Partiiell doppelwandiges Gehäuse aus Edelstahl **AISI 304**, vorgeformte Wanne mit abgerundeten Ecken, gegossene Korbführungsschienen - doppelwandige Tür - Wasch- und Spülarme aus leicht abnehmbarem Verbundwerkstoff - Tür mit Mikroschalter - nutzbare Waschhöhe **30 cm** - Klarspülerspender - automatische Befüllung - Heißspülung - Thermostop-Funktion - Rücklaufventil als Standard. Im Lieferumfang enthalten: 1 Glaskorb 40x40 cm - 1 Löffelkorb - 1 Wasserzulaufschlauch (Länge 2 m) - 1 Ablaufschlauch (Länge 2,5 m).

ES Carrocería de doble pared parcial de acero inoxidable AISI 304, cuba embutida con esquinas redondeadas, guías de los cestos embutidas en la cuba - puerta de doble pared - brazos de lavado y aclarado de material compuesto fácilmente desmontables - microinterruptor en la puerta- altura útil de lavado **30 cm** - Dosificador de abrillantador - llenado automático - aclarado con agua caliente - función Thermostop - válvula antiretorno de serie. Equipado con: 1 cesto vasos 40x40 cm - 1 cestillo cucharillas - 1 tubo de entrada de agua (longitud 2 m) - 1 tubo de desagüe (longitud 2,5 m).

RU Частичная двустенная конструкция из нержавеющей стали **AISI 304**, бак с закругленными углами - бак предварительной формы с закругленными углами, формованные направляющие для корзин - дверца с двойной обшивкой - легко снимаемые ручки для мытья и ополаскивания из композитного материала - микровыключатель на двери - полезная высота мойки **30 см** - дозатор ополаскивателя - автомат наполнение - горячее ополаскивание - функция "Термостоп" - стандартный обратный клапан - поверхностный фильтр из нержавеющей стали. В комплекте: 1 стеклянная корзина 40x40 см - 1 корзина для ложек - 1 наливной шланг (длина 2 м) - 1 сливной шланг (длина 2,5 м).

	LABI40	LABI40PL*
		2,89 kW
 1 Ph		230V/50Hz
		0,19 kW
 h/N.		120" ciclo / cycle 30 cesti all'ora / baskets per hour
		12 L
		2 L
		2,7 kW
		3 L
		2,4 kW
 mm		455 x 550 x 700(h) mm
		
		33,5 Kg
		40,5 Kg
 mm		540 x 630 x 850(h) mm
 m <sup>3</sup>		0,29 m <sup>3</sup>

\* Con dosatore di detersivo elettrico e pompa di scarico  
With electric detergent dispenser and drain pump  
Дополнительно оснащена электрическим дозатором  
мощных средств и сливным насосом

# LAPI50 LAPI50PL

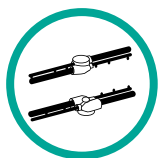

UP/DOWN



MAX H.340 MM



Ø MAX 365 MM - GN1/1

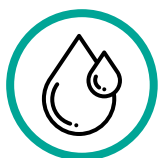

CARICO/SCARICO ACQUA  
WATER INLET/DRAIN



LAPI50

In dotazione: 1 cesto bicchieri 50x50 cm - 1 cesto piatti 50x50 cm (12/18 posti) - 1 cesto porta cucchiaini - 1 tubo di carico acqua (lunghezza 2 m) - 1 tubo di scarico (lunghezza 2,5 m).

Supplied with: 1 glass basket 50x50 cm - 1 plates basket 50x50 cm (12/18 paltet) - 1 spoon basket - 1 water inlet hose (length 2 m) - 1 drain hose (length 2,5 m).

Livré avec: 1 panier à verres 50x50 cm - 1 panier à assiettes 50x50cm (12/18 assiettes) - 1 panier à cuillères - 1 tuyau de chargement d'eau (longueur 2 m) - 1 tuyau de vidange (longueur 2,5 m).

Im Lieferumfang enthalten: 1 Glaskorb 50x50 cm - 1 Tellerkorb 50x50 cm (12/18 Stk.) - 1 Löffelkorb - 1 Wasserzulaufschlauch (Länge 2 m) - 1 Ablaufschlauch (Länge 2,5 m).

Lavastoviglie  
cesto quadrato 50x50 cm

DISHWASHER  
LAVE-VAISSELLES  
SPÜLMASCHINE  
LAVAVAJILLA  
ПОСУДОМОЕЧНАЯ МАШИНА

IT Struttura a doppia parete parziale in acciaio inox **AISI 304**, vasca stampata con angoli arrotondati, correntini guida cesto stampati - porta a doppia parete - bracci di lavaggio e risciacquo in materiale composito facilmente smontabili - microinterruttore su porta - altezza utile lavaggio **34 cm** - possibilità di lavaggio teglie GN1/1 con cesto optional - dosatore di brillantante - riempimento automatico - risciacquo a caldo - funzione Thermostop - valvola antiriflusso di serie.

















EN Partial double skinned structure made of stainless steel **AISI 304**, preshaped tank with rounded corners, moulded basket guide rails - double skinned door - easily removable wash and rins arms made of composite material - door microswitch - useful washing height **34 cm** - optional basket for washing GN1/1 trays - rinse aid dispenser - automatic filling - hot rinsing - Thermostop function - anti-backflow valve as standard.

FR Carrosserie à double paroi partiel en acier inox **AISI 304**, cuve de lavage emboutie avec coins arrondis, supports panier imprimés, porte à double parois - bras de lavage et rinçage en matériau composite facilement amovibles - microrupteur sur la porte - hauteur utile de lavage **34 cm** - possibilité de laver des bacs GN1/1 avec un panier en option - doseur de produit de rinçage - remplissage automatique - rinçage à chaud - fonction Thermostop - soupape anti-retour de série.

DE Partiiell doppelwandiges Gehäuse aus Edelstahl **AISI 304**, vorgeformte Wanne mit abgerundeten Ecken, gegossene Korbführungsschienen - doppelwandige Tür - Wasch- und Spülarme aus leicht abnehmbarem Verbundwerkstoff - Tür mit Mikroschalter - nutzbare Waschhöhe **34 cm** - Klarspülerspender - automatische Befüllung - Heißspülung - Thermostop-Funktion - Rücklaufventil als Standard.

ES Carrocería de doble pared parcial de acero inoxidable **AISI 304**, cuba embutida con esquinas redondeadas, guías de los cestos embutidas en la cuba - puerta de doble pared - brazos de lavado y aclarado de material compuesto fácilmente desmontables - microinterruptor en la puerta - altura útil de lavado **34 cm** - posibilidad de lavar las bandejas GN1/1 con una cesta opcional - dosificador de abrillantador - llenado automático - aclarado con agua caliente - función Thermostop - válvula antiretorno de serie. Equipado con: 1 cesto vasos 50x50 cm - 1 cesto platos 50x50 cm (12/18 platos) - 1 cestillo cucharillas - 1 tubo de entrada de agua (longitud 2 m) - 1 tubo de desagüe (longitud 2,5 m).

RU Частичная двустенная конструкция из нержавеющей стали **AISI 304**, бак с закругленными углами - бак предварительной формы с закругленными углами, формованные направляющие для корзин - дверца с двойной обшивкой - легко снимаемые ручки для мытья и ополаскивания из композитного материала - микровыключатель на двери - квадратная корзина 50x50 см - полезная высота мойки **34 см** - возможность мытья лотков GN1/1 с дополнительной корзиной - дозатор ополаскивателя - автомат наполнение - горячее ополаскивание - функция "Термостоп" - стандартный обратный клапан - поверхностный фильтр из нержавеющей стали. В комплекте: 1 стеклянная корзина 50x50 см - 1 корзина для тарелок 50x50 см (12/18 тарелок) - 1 корзина для ложек - 1 наливной шланг (длина 2 м) - 1 сливной шланг (длина 2,5 м).

	LAPI50	LAPI50PL*
	3,03 kW (1 PH) - 4,83 kW (3 PH)	
	230V/50Hz	
	400V/3N/50Hz	
	0,35 kW	
	120" ciclo / cycle 30 cesti all'ora / baskets per hour	
	20 L	
	2 L	
	2,7 kW (1 PH) - 4,5 kW (3 PH)	
	5 L	
	2,4 kW	
	572 x 633 x 814(h) mm	
		
	50,5 Kg	
	58 Kg	
	660 x 720 x 960(h) mm	
	0,46 m³	

\* Con dosatore di detersivo elettrico e pompa di scarico  
With electric detergent dispenser and drain pump  
Дополнительно оснащена электрическим дозатором  
мощных средств и сливным насосом

OPTIONAL



451

# LAPI50C LAPI50CPL

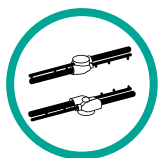

UP/DOWN



MAX H.425 MM



Ø MAX 365 MM - GN1/1

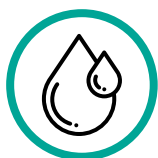

CARICO/SCARICO ACQUA  
WATER INLET/DRAIN



LAPI50C

In dotazione: 1 cesto bicchieri 50x50 cm - 1 cesto piatti 50x50 cm (12/18 posti) - 1 cesto porta cucchiaini - 1 tubo di carico acqua (lunghezza 2 m) - 1 tubo di scarico (lunghezza 2,5 m).

Supplied with: 1 glass basket 50x50 cm - 1 plates basket 50x50 cm (12/18 paltres) - 1 spoon basket - 1 water inlet hose (length 2 m) - 1 drain hose (length 2,5 m).

Livré avec: 1 panier à verres 50x50cm - 1 panier à assiettes 50x50cm (12/18 assiettes) - 1 panier à cuillères - 1 tuyau de chargement d'eau (longueur 2 m) - 1 tuyau de vidange (longueur 2,5 m).

Im Lieferumfang enthalten: 1 Glaskorb 50x50 cm - 1 Tellerkorb 50x50 cm (12/18 Stk.) - 1 Löffelkorb - 1 Wasserzulaufschlauch (Länge 2 m) - 1 Ablaufschlauch (Länge 2,5 m).

Lavastoviglie  
cesto quadrato 50x50 cm

DISHWASHER  
LAVE-VAISSELLES  
SPÜLMASCHINE  
LAVAVAJILLA  
ПОСУДОМОЕЧНАЯ МАШИНА

IT Struttura a singola parete in acciaio inox **AISI 304**, vasca con angoli arrotondati - sistema di sollevamento cappotta a molle - bracci di lavaggio/risciacquo inferiore e superiori in materiale composito facilmente smontabili - microinterruttore su cappotta - altezza utile lavaggio **42,5 cm** - possibilità di lavaggio teglie GN1/1 con cesto optional - dosatore di brillantante - possibilità di start/stop automatico del ciclo di lavaggio con chiusura/apertura della cappotta - riempimento automatico - risciacquo a caldo - funzione Thermostop - valvola antiriflusso di serie - filtro di superficie in acciaio inox.

















EN Mono skinned structure made of stainless steel **AISI 304**, tank with rounded corners - spring assisted hood lifting system - easily removable wash and rins upper and lower arms made of composite material - hood microswitch - useful washing height **42,5 cm** - optional basket for washing GN1/1 trays - rinse aid dispenser - hood operated start/stop functions - automatic filling - hot rinsing - Thermostop function - anti-backflow valve as standard - stainless steel surface filter.

FR Carrosserie à paroi simple en acier inox **AISI 304**, cuve avec coins arrondis, système de levage capot à ressorts - bras de lavage et rinçage inférieurs et supérieurs en matériau composite facilement amovibles - microrupteur sur le capot - hauteur utile de lavage **42,5 cm** - possibilité de laver des bacs GN1/1 avec un panier en option - doseur de produit de rinçage - marche/arrêt à fermeture/ouverture du capot - remplissage automatique - rinçage à chaud - fonction Thermostop - soupape anti-retour de série - filtre de surface de série.

DE Einzelwandiges Gehäuse aus Edelstahl **AISI 304**, Wanne mit abgerundeten Ecken, Haubenhebesystem mit Federn - leicht abnehmbare untere und obere Wasch-/Spülarms aus Verbundwerkstoff - Mikroschalter an der Haube - nutzbare Waschhöhe **42,5 cm** - Die GN 1/1 Bleche können mit einem optionalen Korb gewaschen werden - Klarspülerspender - automatischer Start/Stop des Waschgangs durch Schließen/Öffnen der Haube möglich - automatische Befüllung - Heißspülung - Thermostop-Funktion - Rücklaufventil als Standard - Oberflächenfilter aus Edelstahl.

ES Carrocería de pared simple de acero inoxidable **AISI 304**, cuba con esquinas redondeadas, sistema de elevación de la cúpula con resorte - brazos superiores e inferiores de lavado/aclarado de material compuesto fácilmente desmontables - microinterruptor en la cúpula - altura útil de lavado **42,5 cm** - posibilidad de lavar las bandejas GN1/1 con una cesta opcional - dosificador de abrillantador - Start/stop con cierre/apertura de la capota - llenado automático - aclarado con agua caliente - función Thermostop - válvula antiretorno de serie - filtro de superficie de acero inoxidable. Equipado con: 1 cesto vasos 50x50 cm - 1 cesto platos 50x50 cm (12/18 platos) - 1 cestillo cucharillas - 1 tubo de entrada de agua (longitud 2 m) - 1 tubo de desagüe (longitud 2,5 m).

RU Однослойная конструкция из нержавеющей стали **AISI 304**, бак с закругленными углами - пружинная система подъема крышки/люка - легко снимаемые для мойки и ополаскивания верхние и нижние рычаги, выполненные из композитного материала - микровыключатель вытяжки - полезная высота мойки **42,5 см** - дополнительная корзина для мытья подносов GN1/1 - дозатор ополаскивателя - функции запуска / остановки вытяжки- автомат наполнение - горячее ополаскивание - функция "Термостоп" - стандартный обратный клапан - поверхностный фильтр из нержавеющей стали. В комплекте: 1 стеклянная корзина 50x50 см - 1 корзина для тарелок 50x50 см (12/18 тарелок) - 1 корзина для ложек - 1 наливной шланг (длина 2 м) - 1 сливной шланг (длина 2,5 м).

	LAPI50C	LAPI50CPL*
	6,55 kW	
	400V/3N/50Hz	
	550 W	
	90" ciclo / cycle - 40 cesti all'ora /baskets per hour 120" ciclo / cycle - 30 cesti all'ora / baskets per hour	
	20 L	
	2 L	
	6 kW	
	5 L	
	2,4 kW	
	703 x 757 x 1494(h) mm	
		
	81,5 Kg	
	95 Kg	
	730 x 880 x 1690(h) mm	
	1,09 m³	

\* Con dosatore di detersivo elettrico e pompa di scarico  
With electric detergent dispenser and drain pump  
Дополнительно оснащена электрическим дозатором моющих средств и сливным насосом

# ACCESSORI LAVAGGIO



ACLAVCTSUP35



ACLAVCTSUP40



BV



ACLAVCQ35



ACLAVCQ40



ACLAVCT40



ACLAVCT35

	ACLAVCQ35	ACLAVCQ40	BV	ACLAVCT35	ACLAVCT40	ACLAVCTSUP35	ACLAVCTSUP40
		Cesto quadrato Square basket Panier carré Cesta cuadrada Viereckiger Korb Квадратная корзина		Cesto tondo Round basket Panier rond Cesta redonda Runder Korb Круглый корзина		Supporto per cesto tondo Round basket holder Porte-panier rond Soporte para cestas redondas Runder Korbhalter Опора для круглой корзины	
	350 x 350 x 150(h) mm	400 x 400 x 130(h) mm	500 x 500 x 106(h) mm	Ø 350 x 160(h) mm	Ø 400 x 180(h) mm	350 x 350 mm	400 x 400 mm

i	ACLAVPPOS	CP8	BP	BA	BVM
	Inserto porta posate quadrato Square Cutlery Holder Insert Insert pour porte-couverts carré Portacubiertos Cuadrada Einsatz Besteckhalter Quadratisch Квадратная вставка для лотка для столовых приборов	Inserto porta posate 8 scomparti 8 compartment Cutlery Holder Insert Insert pour porte-couverts à 8 compartiments Einsatz Besteckhalter 8 Fächer Portacubiertos 8 compartimientos Вставка для лотка для столовых приборов 8 отделений	Base piatti 18 piani - 12 fondi Dishes Rack - 18 Dinner Plates - 12 Soup Plates Panier à vaisselle 18 assiettes à diner 12 assiettes creuses Cesta Platos 18 Platos Llanos 12 Platos Hondos Tellerkorb 18 Flache Teller 12 Tiefe Teller Основание для тарелок 18 обеденных тарелок 12 суповых тарелок	Base vassoi 9 vassoi Trays Rack 9 Trays Panier à plateaux 9 plateaux Cesta Bandejas 9 Bandejas Tablettkorb 9 Tablett Основание для лотков 9 лотков	Base posate Cutlery Rack Panier à couverts Cesta Cubiertos Besteckkorb Основание для столовых приборов
mm	113 x 113 x 89(h) mm	430 x 200 x 120(h) mm	500 x 500 x 106(h) mm		



ACLAVPPOS



CP8



BP



BVM



B9

i	B9	B16	B25	B36	B49
	BASE PER BICCHIERI CON SEPARATORI COMPRESI - GLASSSES BASE WITH SPACERS - SUPPORT POUR VERRES AVEC SÉPARATEURS - GLÄSERKORB MIT TRENNWÄNDE CESTA POR VASOS CON SEPARADORES INCLUIDOS - ОСНОВАНИЕ СТАКАН СО ПЕРЕГОРОДКА				
	SEPARATORE / COMPARTMENT DIVIDER / SÉPARATEUR COMPARTIMENTS / SEPARADOR / TRENNWAND FÄCHER / ПЕРЕГОРОДКА ОТДЕЛЕНИЙ				
	n. 9	n. 16	n. 25	n. 36	n. 49
mm	max Ø 150 mm	max Ø 110 mm	max Ø 89 mm	max Ø 73 mm	max Ø 62 mm

# ACCESSORI LAVAGGIO

	RIA9	RIA16	RIA25	RIA36	RIA49	RIAU	COPCEST
	<b>RIALZO BICCHIERI CON SEPARATORI COMPRESI</b> <b>EXTENDER FOR GLASSES WITH SPACERS</b> <b>PROLONGE POUR VERRES AVEC SÉPARATEURS INCLUS</b> <b>GLÄSER-AUFSATZ MIT TRENNWÄNDE</b> <b>REALCE POR VASOS CON SEPARADORES INCLUIDOS</b> <b>ЛОТОК ЧАШИ СО ПЕРЕГОРОДКА</b>					Rialzo universale adatto all'inserimento di separatori  Universal extender possibility of insertion of dividers  Prolonge universelle Adapté à l'insertion de séparateurs  Realce universal con posibilidad de introducir separadores  Universal-Aufsatz Geeignet für den Einsatz von Trennwände  Универсальный лоток подходит для установки сепараторов	Coperchio universale  Universal cover  Couvercle universel  Tapa universal  Universaldeckel  Универсальная крышка
	<b>SEPARATORE / COMPARTMENT DIVIDER / SÉPARATEUR COMPARTIMENTS / SEPARADOR / TRENNWAND FÄCHER / ПЕРЕГОРОДКА ОТДЕЛЕНИЙ</b>						
	n. 9	n. 16	n. 25	n. 36	n. 49		
	max Ø 150 mm	max Ø 110 mm	max Ø 89 mm	max Ø 73 mm	max Ø 62 mm		
	500 x 500 x 50(h) mm					500 x 500 x 50(h) mm	500 x 500 x 25(h) mm

## NOT FOR SALE IN EXCE COUNTRY

	< 15°F		>15°F	
	ACLAVDETS	ACLAVBRILLS	ACLAVDETH	ACLAVBRILLH
	<b>CONFEZIONI / PACKS FOR SALE</b>			
	2x5 Kg	2x6 Kg	2x5 Kg	2x6 Kg
	Detergente liquido igienizzante per lavastoviglie adatto per acque dolci  Sanitising liquid dishwasher detergent suitable for fresh water  Détergent liquide assainissant pour lave-vaisselle, adapté à l'eau douce  Sanitisierendes flüssiges Geschirrspülmittel für Süßwasser geeignet  Detergente líquido higienizante para lavavajillas, apto para agua dulce	Brillantante-additivo risciacquo per lavastoviglie adatto per acque dolci  Rinse additive rinse aid for dishwashers suitable for fresh water  Additif de rinçage pour lave-vaisselle adapté à l'eau douce  Klarspülerzusatz / Klarspüler für Geschirrspüler geeignet für Süßwasser  Aditivo de aclarado para lavavajillas apto para agua dulce	Detergente liquido igienizzante per lavastoviglie adatto per acque medie e dure  Sanitising liquid dishwasher detergent suitable for medium to hard water  Détergent liquide assainissant pour lave-vaisselle, adapté aux eaux moyennes et dures  Sanitisierendes flüssiges Geschirrspülmittel geeignet für mittleres und hartes Wasser  Detergente líquido higienizante para lavavajillas, apto para aguas medias y duras	Brillantante-additivo risciacquo per lavastoviglie adatto per acque medie e dure  Rinse additive rinse aid for dishwashers suitable for medium to hard water  Additif de rinçage pour lave-vaisselle, adapté aux eaux moyennes et dures  Klarspülerzusatz / Klarspüler für Geschirrspüler geeignet für mittleres und hartes Wasser  Aditivo de aclarado para lavavajillas apto para aguas medias y duras











Per modelli / only for models LAPI50C / LAPI50CPL

# TAVOLI ENTRATA E USCITA



IN AND OUTLET TABLES - TABLE D'ENTRÉE ET SORTIE - EIN UND AUSLAUFTISCHE  
MESAS DE ENTRADA Y SALIDA - ТАБЛИЦЫ ВХОДОВ И ВЫХОДОВ

	ACTAVOUT80 (DX O SX)	ACTAVOUT100 (DX O SX)	ACTAVOUT120 (DX O SX)	ACTAVINCV (DX O SX)	ACTAVINV (DX O SX)
	TAVOLO USCITA CON ALZATINA OUTLET TABLE WITH BACKSPLASH TABLE DE SORTIE AVEC DOSSERET AUSLAUFTISCH MIT AUFKANTUNG			TAVOLO ENTRATA CERNITA CON VASCA CON ALZATINA INLET TABLE WITH BOWL WASTE HOLE AND BACKSPLASH TABLE D'ENTRÉE AVEC CUVE TROU DE VIDANGE ET DOSSERET ZULAUFTISCH MIT BECKEN ABFALLÖFFUNG UND AUFKANTUNG	
	810 x 640 x 850/900(h) mm	1010 x 640 x 850/900(h) mm	1210 x 640 x 850/900(h) mm	1210 x 780 x 850/900(h) mm	
	31 Kg	36 Kg	42 Kg	41 Kg	
	34 Kg	40 Kg	46,5 Kg	45 Kg	
	900 x 700 x 1100(h) mm	1100 x 700 x 1100(h) mm	1300 x 700 x 1100(h) mm	1300 x 800 x 1100(h) mm	
	0,57 m <sup>3</sup>	0,70 m <sup>3</sup>	0,84 m <sup>3</sup>	1,06 m <sup>3</sup>	

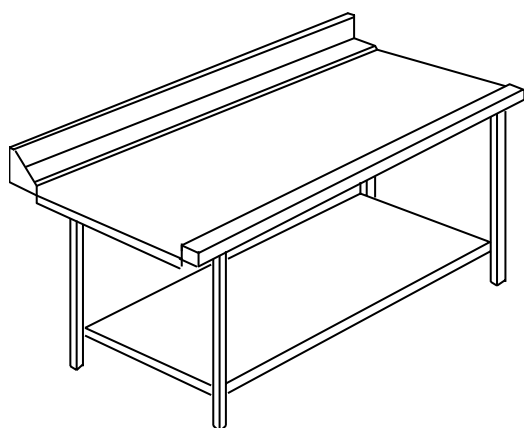

ACTAVOUT100

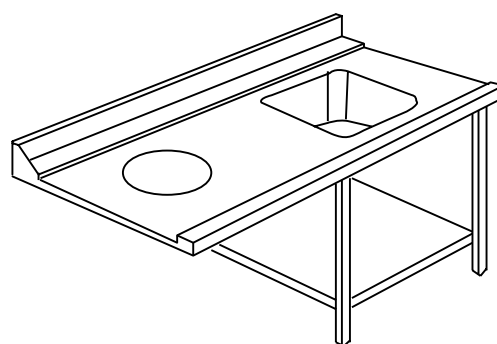

ACTAVINCV

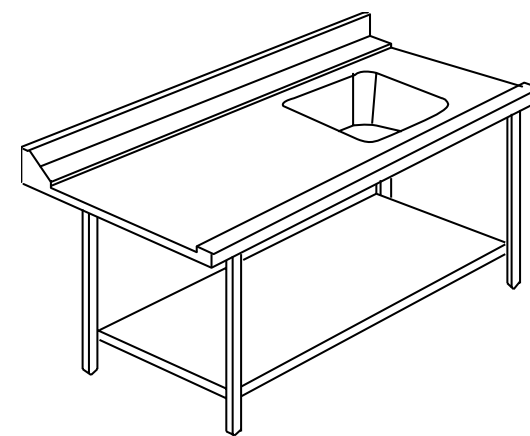

ACTAVINV



AL MOMENTO DELL'ORDINE SPECIFICARE SE AGGANCIO A SINISTRA O A DESTRA PER ENTRAMBI I TAVOLI  
PLEASE SPECIFY WHEN ORDERING IF LEFT OR RIGHT FASTENING FOR BOTH TABLES  
LORS DE LA COMMANDE, VEUILLEZ PRÉCISER POUR LES DEUX TABLES SI L'ACCROCHAGE DOIT SE FAIRE À GAUCHE OU À DROITE  
AL HACER EL PEDIDO, INDIQUE PARA AMBAS MESAS SI SE REQUIERE LA FIJACIÓN A LA IZQUIERDA O A LA DERECHA  
BITTE GEBEN SIE BEI DER BESTELLUNG FÜR BEIDE TISCHE AN, OB DIE BEFESTIGUNG LINKS ODER RECHTS SEIN SOLL  
ПРИ ЗАКАЗЕ, ПОЖАЛУЙСТА, УКАЖИТЕ ДЛЯ ОБОИХ СТОЛОВ, ТРЕБУЕТСЯ ЛИ ЛЕВОЕ ИЛИ ПРАВОЕ КРЕПЛЕНИЕ

# HC-DEGREASERF750 HC-DEGREASERF5K



HC-DEGREASERF750



HC-DEGREASERF5K

Foglietto illustrativo in italiano, inglese, francese, spagnolo, tedesco, romeno, ceco, croato, sloveno.

Suitable for use in the HACCP field. Package leaflet in: Italian, English, French, Spanish, German, Romanian, Czech, Croatian, Slovenian.

Convient pour une utilisation dans le domaine HACCP. Notice en: Italien, anglais, français, espagnol, allemand, roumain, tchèque, croate, slovène.

Apto para su uso en el ámbito HACCP. Prospecto en: Italiano, inglés, francés, español, alemán, rumano, checo, croata, esloveno.

**IT** Sgrassante rapido pronto uso - alto potere pulente - indicato per sgrassare unto, olio, grasso e residui carbonizzati. Specifico per attrezzature professionali come friggitrice, piastre di cottura, tritacarne etc. Utilizzabile su tutte le superfici lavabili rilasciando una gradevole profumazione - adatto all'uso in ambito HACCP.

**HC-DEGREASERF750:** minimo di ordine confezione completa da 6 pezzi (750 ml cad.) 2 erogatori + 4 ricariche

**HC-DEGREASERF5K:** tanica da 5 L

**EN** Ready to use fast degreaser - high cleaning power - ideal to remove grease, oil and charred residues. It is especially suitable for professional equipment such as fryers, cooking plates, meat grinders, etc. Suitable for all washable surfaces, it releases a pleasant scent. Suitable for use in the HACCP field.

**HC-DEGREASERF750:** minimum order quantity 6-pack (750 ml each)

2 dispensers + 4 refills

**HC-DEGREASERF5K:** 5 L canister

**FR** Dégraissant rapide prêt à l'emploi - haut pouvoir nettoyant - convient pour déterger les graisses, huiles, gras et résidus carbonisés. Destinée spécifiquement aux équipements professionnels tels que les friteuses, les plaques de cuisson, les hachoirs à viande, etc. Peut être utilisé sur toutes les surfaces lavables, avec un parfum agréable - convient pour une utilisation dans le domaine HACCP.





**HC-DEGREASERF750:** quantité minimale de commande un paquet de 6 unités (750 ml chacune) 2 doseurs + 4 recharges

**HC-DEGREASERF5K:** bidon de 5 L

**ES** Desengrasante rápido listo para usar - alto poder de limpieza - ideal para eliminar grasa, aceite y residuos carbonizados. Está especialmente indicado para equipos profesionales como freidoras, placas de cocina, picadoras de carne, etc. Apto para todas las superficies lavables, desprende un agradable aroma. Apto para su uso en el ámbito HACCP.

**HC-DEGREASERF750:** cantidad mínima de pedido paquete de 6 (750 ml cada uno) 2 dispensadores + 4 recambios

**HC-DEGREASERF5K:** bidón de 5 L

	HC-DEGREASERF750 min. 6 pc	HC-DEGREASERF5K
		
	-	185 x 110 x 315(h) mm
	5 Kg	5 Kg
	5,3 Kg	5,3 Kg
	255 x 175 x 315(h) mm	370 x 260 x 260(h) mm

# HC-SANICLEANF750 HC-SANICLEANF5L



HC-SANICLEANF750



HC-SANICLEANF5L

Foglietto illustrativo in italiano, inglese, francese, spagnolo, tedesco, romeno, ceco, croato, sloveno.

Suitable for use in the HACCP field. Package leaflet in: Italian, English, French, Spanish, German, Romanian, Czech, Croatian, Slovenian.

Convient pour une utilisation dans le domaine HACCP. Notice en: Italien, anglais, français, espagnol, allemand, roumain, tchèque, croate, slovène.

Apto para su uso en el ámbito HACCP. Prospecto en: Italiano, inglés, francés, español, alemán, rumano, checo, croata, esloveno.

**IT** Detergente igienizzante pronto uso - adatto per tutte le superfici lavabili - specifico per uso nel settore alimentare. La sua formulazione permette un'efficace igienizzazione e veloce asciugatura - adatto all'uso in ambito HACCP.

**HC-SANICLEANF750:** minimo di ordine confezione completa da 6 pezzi (750 ml cad.) 2 erogatori + 4 ricariche

**HC-SANICLEANF5L:** tanica da 5 L

**EN** Ready to use sanitising cleaner - suitable for all washable surfaces - specific for use in the food industry. Its formula allows effective sanitation and fast drying - suitable for use in the HACCP field.

**HC-SANICLEANF750:** minimum order quantity 6-pack (750 ml each)  
2 dispensers + 4 refills

**HC-SANICLEANF5L:** 5 L canister

**FR** Détergent désinfectant prêt à l'emploi - adapté à toutes les surfaces lavables - conçu spécialement pour être utilisé dans l'industrie alimentaire. Sa formulation permet un assainissement efficace et un séchage rapide - convient pour une utilisation dans le domaine HACCP.





**HC-SANICLEANF750:** quantité minimale de commande un paquet de 6 unités (750 ml chacune) 2 doseurs + 4 recharges

**HC-SANICLEANF5L:** bidon de 5 L

**ES** Detergente desinfectante listo para usar, apto para todas las superficies lavables, específico para la industria alimentaria. Su formulación permite una higienización eficaz y un secado rápido, apto para su uso en el ámbito HACCP.

**HC-SANICLEANF750:** cantidad mínima de pedido paquete de 6 (750 ml cada uno) 2 dispensadores + 4 recambios

**HC-SANICLEANF5L:** bidón de 5 L

	HC-SANICLEANF750 min. 6 pc	HC-SANICLEANF5L
		
	-	185 x 110 x 315(h) mm
	5 Kg	5 Kg
	5,3 Kg	5,3 Kg
	255 x 175 x 315(h) mm	370 x 260 x 260(h) mm

Igienizzante superfici  
Sanitiser for surfaces

Desinfectant de surfaces  
Desinfectante de superficies

# HC-MULTIF750 HC-MULTIF5K



HC-MULTIF750



HC-MULTIF5K

Foglietto illustrativo in italiano, inglese, francese, spagnolo, tedesco, romeno, ceco, croato, sloveno.

Suitable for use in the HACCP field. Package leaflet in: Italian, English, French, Spanish, German, Romanian, Czech, Croatian, Slovenian.

Convient pour une utilisation dans le domaine HACCP. Notice en: Italien, anglais, français, espagnol, allemand, roumain, tchèque, croate, slovène.

Apto para su uso en el ámbito HACCP. Prospecto en: Italiano, inglés, francés, español, alemán, rumano, checo, croata, esloveno.

**IT** Detergente pulitore adatto a qualsiasi superficie lavabile, ideale su piani in acciaio, cucine professionali e laboratori di panificazione e pasticceria. Rimuove aloni, macchie e contaminazioni non gravose - gradevolmente profumato non lascia aloni - facile asciugatura.

**HC-MULTIF750:** minimo di ordine confezione completa da 6 pezzi (750 ml cad.)  
2 erogatori + 4 ricariche

**HC-MULTIF5K:** tanica da 5 L

**EN** Cleaner suitable for any washable surface, ideal for on steel tops, professional kitchens and bakery and pastry laboratories. It removes halos streaks, spots and slight minor contamination - pleasantly smelling scented - leaves no halos streaks - easy to dry.

**HC-MULTIF750:** minimum order quantity 6-pack (750 ml each)  
2 dispensers + 4 refills

**HC-MULTIF5K:** 5 L canister

**FR** Détergent convenant à toute surface lavable, idéal pour les plans de travail en acier, les cuisines professionnelles et les pâtisseries ou boulangeries. Enlève les tâches, les souillures et les contaminations légères - agréablement parfumé, ne laisse aucune trace - facile à sécher.





**HC-MULTIF750:** quantité minimale de commande un paquet de 6 unités (750 ml chacune) 2 doseurs + 4 recharges

**HC-MULTIF5K:** bidon de 5 L

**ES** Detergente apto para cualquier superficie lavable, ideal en encimeras de acero, cocinas profesionales y pastelerías o panaderías. Elimina halos, manchas y contaminaciones no severas - agradablemente perfumado, no deja halos - secado rápido.

**HC-MULTIF750:** cantidad mínima de pedido paquete de 6 (750 ml cada uno)  
2 dispensadores + 4 recambios

**HC-MULTIF5K:** bidón de 5 L

	<b>HC-MULTIF750</b> min. 6 pc	<b>HC-MULTIF5K</b>
		
	-	185 x 110 x 315(h) mm
	5 Kg	5 Kg
	5,3 Kg	5,3 Kg
	255 x 175 x 315(h) mm	370 x 260 x 260(h) mm

# HC-FLASHF750



HC-FLASHF750

Foglietto illustrativo in italiano, inglese, francese, spagnolo, tedesco, romeno, ceco, croato, sloveno.

Suitable for use in the HACCP field. Package leaflet in: Italian, English, French, Spanish, German, Romanian, Czech, Croatian, Slovenian.

Convient pour une utilisation dans le domaine HACCP. Notice en: Italien, anglais, français, espagnol, allemand, roumain, tchèque, croate, slovène.

Apto para su uso en el ámbito HACCP. Prospecto en: Italiano, inglés, francés, español, alemán, rumano, checo, croata, esloveno.

IT Igienizzante multisuperfici pronto uso gradevolmente profumato. Conformità al protocollo n. 5443 del 22 febbraio 2020 dove indicato come igienizzante il perossido di idrogeno ad una concentrazione di almeno 0,5% per un tempo adeguato di contatto - adatto all'uso in ambito HACCP.

**HC-FLASHF750:** minimo di ordine confezione completa da 6 pezzi (750 ml cad.)  
2 erogatori + 4 ricariche

EN Multi-surface sanitiser, ready to use and pleasantly smelling scented. Compliance with the Protocol no. 5443 dated 22 February 2020 where hydrogen peroxide is indicated as a sanitiser at a concentration of at least 0.5% for an appropriate contact. Suitable for use in the HACCP field.





**HC-FLASHF750:** minimum order quantity 6-pack (750 ml each)  
2 dispensers + 4 refills

FR Hygiénisant multi-surfaces prêt à l'emploi agréablement parfumé. En conformité avec le protocole n° 5443 du 22 février 2020 où le peroxyde d'hydrogène est indiqué comme désinfectant à une concentration d'au moins 0,5% pour un temps de contact adéquat - utilisable dans le domaine HACCP.

**HC-FLASHF750:** quantité minimale de commande un paquet de 6 unités (750 ml chacune) 2 doseurs + 4 recharges

ES Desinfectante multisuperficie listo para usar agradablemente perfumado. Según el protocolo nº 5443 del 22 de febrero de 2020, en el que se indica el peróxido de hidrógeno como desinfectante a una concentración de al menos el 0,5% durante un tiempo de contacto adecuado - apto para su uso en el ámbito HACCP.

**HC-FLASHF750:** cantidad mínima de pedido paquete de 6 (750 ml cada uno)  
2 dispensadores + 4 recambios

	<b>HC-FLASHF750</b> min. 6 pc
	
	-
	5 Kg
	5,3 Kg
	255 x 175 x 315(h) mm

Igienizzante con perossido di idrogeno  
Sanitiser with hydrogen peroxide

Hygiénisant avec peroxyde d'hydrogène  
Higienizador con peróxido de hidrógeno

# HC-IGIENGELF500 HC-IGIENGELF5L



HC-IGIENGELF500

HC-IGIENGELF5L

Foglietto illustrativo in italiano, inglese, francese, spagnolo, tedesco, romeno, ceco, croato, sloveno.

Suitable for use in the HACCP field. Package leaflet in: Italian, English, French, Spanish, German, Romanian, Czech, Croatian, Slovenian.

Convient pour une utilisation dans le domaine HACCP. Notice en: Italien, anglais, français, espagnol, allemand, roumain, tchèque, croate, slovène.

Apto para su uso en el ámbito HACCP. Prospecto en: Italiano, inglés, francés, español, alemán, rumano, checo, croata, esloveno.

IT Gel alcolico igienizzante che grazie all'alto tenore di alcool al suo interno (del 70%) favorisce una veloce e facile igienizzazione delle mani. Facile asciugatura e gradevole profumazione, permette un'applicazione ripetuta senza effetti sgradevoli.

**HC-IGIENGELF500:** box da 6 pezzi (500 ml cad.)

**HC-IGIENGELF5L:** tanica da 5 L

EN Hygienizing alcoholic gel which, thanks to its high alcohol content (70%), promotes quick and easy hygiene of the hands. Easy drying and pleasant fragrance, it allows repeated applications without unpleasant effects.

**HC-IGIENGELF500:** box of 6 pieces (500 ml each)

**HC-IGIENGELF5L:** 5 L canister

FR Gel alcoolique hygiénisant qui, grâce à sa forte concentration en alcool (70%), permet une désinfection rapide et facile des mains. Séchage facile et parfum agréable, il permet une application répétée sans effets désagréables.

**HC-IGIENGELF500:** boîte de 6 pièces (500 ml chacune)

**HC-IGIENGELF5L:** bidon de 5 litres

ES Gel alcohólico higienizante que gracias a su alto contenido en alcohol (70%) favorece una rápida y fácil higienización de las manos. De fácil secado y agradable fragancia, permite una aplicación repetida sin efectos desagradables.

**HC-IGIENGELF500:** caja de 6 piezas (500 ml cada una)

**HC-IGIENGELF5L:** bidón de 5 L

	HC-IGIENGELF500 min. 6 pc	HC-IGIENGELF5L
	-	185 x 110 x 315(h) mm
	3 Kg	5 Kg
	4 Kg	5,3 Kg
	240 x 240 x 170(h) mm	370 x 260 x 260(h) mm

# HC-GELSTK200



Foglietto illustrativo in italiano, inglese, francese, spagnolo, tedesco, romeno, ceco, croato, sloveno.

Suitable for use in the HACCP field. Package leaflet in: Italian, English, French, Spanish, German, Romanian, Czech, Croatian, Slovenian.

Convient pour une utilisation dans le domaine HACCP. Notice en: Italien, anglais, français, espagnol, allemand, roumain, tchèque, croate, slovène.

Apto para su uso en el ámbito HACCP. Prospecto en: Italiano, inglés, francés, español, alemán, rumano, checo, croata, esloveno.

IT Comodo stick gel monouso - 60% di alcool - utilizzabile senza acqua - elimina i batteri presenti sulle mani senza aggredire la pelle - non unge e non macchia. Gel non aggressivo con base idroalcolica - proprietà antimicrobiche - idrata la pelle e lascia le mani profumate.

**HC-GELSTK200:** 1 box da 200 sticks

EN Easy to use disposable stick gel - 60% alcohol - no water required eliminates bacteria on hands without irritating the skin - no grease and no stain. Non-aggressive gel with hydro-alcoholic base - antimicrobial properties - moisturises the skin and leaves the hands scented.





**HC-GELSTK200:** 1 box of 200 sticks

FR Bâton de gel pratique et jetable - 60% d'alcool - peut être utilisé sans eau - élimine les bactéries sur les mains sans attaquer la peau - ne graisse pas et ne tache pas. Gel non agressif à base hydro-alcoolique - propriétés antimicrobiennes - hydrate la peau et laisse vos mains parfumées.

**HC-GELSTK200:** 1 boîte de 200 bâtonnets

ES Práctica barra de gel desechable - 60% de alcohol - puede utilizarse sin agua - elimina las bacterias de las manos sin atacar la piel - no engrasa y no mancha. Gel no agresivo con base hidroalcohólica - propiedades antimicrobianas - hidrata la piel y deja las manos perfumadas.

**HC-GELSTK200:** 1 caja de 200 barritas

	HC-GELSTK200
	
 mm	-
 NET Kg	0,5 Kg
 GROSS Kg	0,58 Kg
 mm	150 x 100 x 200(h) mm

Stick gel monouso  
Disposable stick gel

Bâtonnet de gel jetable  
Barrita de gel desechable













**Fimar S.p.a.**

Via Del Tesoro, 301

47826 Villa Verucchio (Rimini) Italy

t. +39 0541 670736

info@fimargroup.it

**FIMARGROUP.IT**  
**FIMARSPA.IT**  
**EASYLINEBYFIMAR.IT**  
**FORCAR.IT**  
**FORCOLD.IT**